

WITH EFFECT FROM 21<sup>ST</sup> FEBRUARY 2023

# Electrification products price list (₹)





# Electrification products

ABB is a global leader in power and automation technologies that enable utility and industry customers to improve performance while lowering environmental impact. ABB in India serves customers in process, manufacturing and consumer industries, utilities, the oil & gas sector and infrastructure markets through a wide manufacturing and marketing network.

ABB offers a full range of low-voltage and medium-voltage solutions to connect, protect, control and measure a wide range of electrical systems for all major industries, including the residential sector.

The business improves the reliability and efficiency of electrical installations through modular substation packages, distribution automation products, switchgear, circuit breakers, measuring and sensing devices, control products, wiring accessories, and enclosures and cabling

systems, including KNX systems designed to integrate and automate a building's lighting, ventilation, heating, security and data communication networks.

ABB's product range serves the diverse needs of customers, offering value-for-money and high levels of quality and reliability. These products are backed by the technological expertise of ABB's centres of excellence across the globe, each of which excel in a specific range of low voltage products.

ABB's electrification products offering in India are designed, manufactured and tested in-house in conformance with requirements of the ISO 9000 series. These products conform to the latest IEC standards, EN specifications, national standards such as IS, BS, VDE, etc., in addition to the "CE" mark.

---

# Table of contents

## Smart Power products

09	ABB's comprehensive range of breakers and switches
10	Introduction SACE Emax 2
11	Formula Air
12	SACE Tmax XT
13	ArTuK Born certified
14–15	ABB Ability™ Energy and Asset Manager
16–17	Architecture Truly plug & play
18	ABB Formula DSP P1-P4 - New
19	SACE Tmax XT range
20	Tmax circuit breakers
21–26	Tmax power distribution circuit breakers
27–29	Tmax motor protection circuit breakers
30–36	Tmax accessories
37–38	Tmax conversion kit
39	Tmax PV: Photovoltaic range molded case switch disconnectors
40–41	FORMULA DSA Molded case circuit breaker
42	Switches
43	DC switch disconnectors for PV application
44	Fusegear
45	Vertical Fuse Switch Disconnectors
46–47	OFAF HRC fuse links and base, DIN-type & BS-type
48–49	OESA/OS switch disconnector fuse, DIN-type & BS-type
50	Accessories for OESA/OS switch disconnector fuse, 32..800 A
51–53	OT switch disconnectors & accessories
54	Enclosed switches
55	Zenith Auto Transfer Switch
56	The world's first true ATS is here Introducing TruONE
57	Automatic transfer switches - IEC
57	Enclosed automatic transfer switches - IEC
58	Compact ATS

<b>59</b>	<b>OT manual changeover switches</b>
<b>60</b>	<b>OT motorized changeover switches</b>
<b>61</b>	<b>Kabeldon low voltage switchgear system</b>
<b>62</b>	<b>ABB's comprehensive range of LV control products</b>
<b>63–67</b>	<b>Motor starting and protection</b>
<b>68</b>	<b>Auxiliary contactors</b>
<b>69</b>	<b>3 pole contactors: AX09...AX370 : AC operated</b>
<b>70</b>	<b>3 pole contactors: AC operated</b>
<b>71</b>	<b>4 pole contactors: AC operated</b>
<b>72</b>	<b>3 pole contactors AL and TAL range: DC operated</b>
<b>73</b>	<b>Contactors for special application-capacitors switching</b>
<b>74</b>	<b>Contactors for DC circuit switching: AC/DC operated</b>
<b>75–76</b>	<b>Accessories for contactors</b>
<b>77</b>	<b>Contactors: Wide band AC/DC operated</b>
<b>78–79</b>	<b>Novolink™ – smart function and sensor modules for AF contactors - New</b>
<b>80</b>	<b>3 pole contactors AF range: Wide band AC/DC operated</b>
<b>81</b>	<b>4 pole contactors: Wide band AC/DC operated</b>
<b>82–83</b>	<b>Accessories for AF contactors</b>
<b>84–85</b>	<b>AFC contactors for AC control applications - New</b>
<b>86</b>	<b>Powerful light switching made easy</b>
<b>87–89</b>	<b>ESB and EN Installation contactors</b>
<b>90</b>	<b>Mini contactors</b>
<b>91</b>	<b>DOL and star delta starters</b>
<b>92–95</b>	<b>Manual motor starter</b>
<b>96–98</b>	<b>Thermal overload relays</b>
<b>99</b>	<b>Electronic overload relays class 10, 20, 30</b>
<b>100–102</b>	<b>Push-in Spring motor starting solution - New</b>
<b>103–105</b>	<b>Softstarters</b>
<b>106</b>	<b>AFS contactors with front-mounted auxiliary contact blocks</b>
<b>107–109</b>	<b>M mini contactors and contactor relays - New</b>

---

# Table of contents

<b>110</b>	<b>Electronic compact starters: HF range</b>
<b>111–112</b>	<b>Limit switches - New</b>
<b>113–125</b>	<b>Pilot devices</b>
<b>126–128</b>	<b>Signal tower and beacons</b>
<b>129</b>	<b>Electronic products and relays</b>
<b>130–137</b>	<b>CT-C/CT-S Product Portfolio</b>
<b>131–134</b>	<b>Electronic products and relays</b>
<b>135–137</b>	<b>CP range</b>
<b>138–139</b>	<b>Smart temperature monitoring relay - New</b>
<b>140–145</b>	<b>Intelligent motor management system - UMC100.3 &amp; accessories</b>
<b>146–147</b>	<b>Arc flash protection and mitigation solutions</b>
<b>148–149</b>	<b>Production-friendly safety systems</b>
<b>150–157</b>	<b>ABB safety</b>
<b>158–169</b>	<b>Uninterruptible Power Supply Systems</b>

## Smart Building products

<b>170–173</b>	<b>Electrical installation solutions for buildings</b>
<b>174–180</b>	<b>Miniature Circuit Breaker SB200 M &amp; characteristic</b>
<b>181–183</b>	<b>Miniature Circuit Breaker SB200 DC &amp; characteristic</b>
<b>184</b>	<b>Miniature Circuit Breaker (MCB) S200 series - 80, 100A</b>
<b>185–186</b>	<b>Miniature Circuit Breaker SH800 (80-125A)</b>
<b>187–189</b>	<b>Switch Disconnecter SDB200 and E200</b>
<b>190–192</b>	<b>Residual Current Circuit Breaker FB200 and F200 higher rating</b>
<b>194</b>	<b>RCCB with overcurrent protection RCBO - DS201M series</b>
<b>195</b>	<b>RCCB with overcurrent protection RCBO - DSB201M series AC Type - New</b>
<b>196–197</b>	<b>RCCB with overcurrent protection Factory Fitted RCBO DSB202M and DSB204M - New</b>
<b>198</b>	<b>RCCB with overcurrent protection RCBO - DSB201M series A Type - New</b>
<b>199–200</b>	<b>Solution for unwanted tripping - AP-R type (high immunity) RCCB F200/RCBO</b>

<b>201–211</b>	<b>System pro M: Auxiliary elements for MCB's-SB200M, S200M, RCCB's-FB200, F200 and RCBO's-DS201M,DSB201M</b>
<b>212–215</b>	<b>Wiring diagram &amp; Overall dimensions</b>
<b>216–217</b>	<b>Surge protection devices - The new OVR QuickSafe®</b>
<b>218–219</b>	<b>DBT Timer digital time switches - New</b>
<b>220–221</b>	<b>SMISLINE TP plug-in system</b>
<b>222</b>	<b>ELR, Earth leakage relay - (DIN &amp; front panel mountable)</b>
<b>224–229</b>	<b>ABB Energy Efficiency Portfolio</b>
<b>230–231</b>	<b>M1 Single Function &amp; M1M Multi Function Meters</b>
<b>232–238</b>	<b>M1M Power Meters</b>
<b>240–249</b>	<b>M4M Network Analyzers</b>
<b>250–253</b>	<b>EQ matic energy meters</b>
<b>254–263</b>	<b>ABB ITUS Enclosures</b>
<b>264–270</b>	<b>Elegance series Enclosures</b>
<b>271–276</b>	<b>Classic series Enclosures</b>
<b>277</b>	<b>Mistral IP 65 enclosures</b>
<b>278</b>	<b>Gemini switchboard</b>
<b>279–283</b>	<b>Wiring Accessories - Millenium &amp; Zenit</b>
<b>284–297</b>	<b>Wiring Accessories - IVIE</b>
<b>298–304</b>	<b>Wiring Accessories - Tvisha, Tvisha white &amp; Anti-bacterial</b>
<b>305–306</b>	<b>Wiring Accessories - Snieo</b>
<b>307–309</b>	<b>Busch-Presence detectors</b>
<b>310</b>	<b>Emergency lighting systems</b>
<b>311–314</b>	<b>Industrial plugs and sockets</b>

---

# Table of contents

## Installation products

<b>315</b>	<b>Installation products</b>
<b>316</b>	<b>Flexible conduit system</b>
<b>317–319</b>	<b>External lightning protection</b>

## Protection and Automation Relays

<b>320</b>	<b>Section I: Auxiliary relays, tripping relays and timers</b>
<b>321–322</b>	<b>Section II: Electro-mechanical high speed tripping relays, Bi-stable relays and static relays</b>
<b>323–326</b>	<b>Type 2 co-ordination</b>
<b>327</b>	<b>Spares for contactors</b>
<b>328–329</b>	<b>Service portfolio</b>
<b>330–332</b>	<b>Materials</b>
<b>333–335</b>	<b>Electrification India eMart &amp; offerings</b>
<b>336–337</b>	<b>General conditions of sale</b>



# ABB's comprehensive range of breakers and switches

The range of ABB breakers and switches ranks amongst the most extensive on the market with a full range of innovative solutions for various applications, helping to optimise resources, reduce energy costs, boost productivity.

- Air circuit breakers
- Molded case circuit breakers
- HRC fuse & fuse base
- Switch disconnecter fuse
- Switch disconnectors
- Changeover switches - manual & motorized
- Auto transfer switches
- Cable distribution cabinet - Kabeldon
- Fuse gear - easyline and inline (Fuse switch disconnecter)
- Switch disconnecter for DC and photovoltaic application
- MCCB for DC and photovoltaic application



## SACE Emax 2

The all-in-one innovation



The world of electrical power distribution changes fast and major new trends such as renewables, energy storage and microgrids are now crowding onto the stage. These trends lead to new customer and application demands.

To meet these demands, ABB has now unveiled the innovative Emax 2 all-in-one, the evolution of the Emax 2 into a multifunctional platform that is able to manage the next generation of electrical distribution systems such as microgrids.

Emax 2 all-in-one is the first circuit breaker that meets new grid requirements. It enables a direct communication to the new energy management cloud-computing platform ABB Ability™ Energy and Asset Management.

Smart plug and play architecture makes Emax 2 all-in-one easy to use. Leveraging also unmatched electrical performances, Emax 2 sets a new circuit breaker benchmark for the needs of today and tomorrow.

SACE Emax 2, the all-in-one solution to manage "low-voltage distribution systems".

### Efficiency

New advanced functionalities, together with Protection trip units, Communication and system devices contribute to make SACE Emax 2 the circuit breaker that maximizes efficiency in all low-voltage electrical installation.

### Control

SACE Emax 2 circuit breaker is the first single device ready to manage all the dynamics of a low-voltage electrical installation.

Managing loads in any condition is now possible thanks to Advanced Functionalities such as:

- **Power controller.**  
Patented algorithm to reduce the peak of power consumed, allowing savings on electricity bills.
- **Embedded ATS functions.**  
An automatic transfer system used in all application where continuity is essential and where there are multi source supplies.
- **Synchro-reclosing.**  
Synchronization and automatic reconnection of the Microgrid to the main grid when the power is back.
- **Interface protection system and Interface Device.**  
Check of grid-connected operation that shall be immediately and automatically interrupted in case of outage of the distribution grid or when the voltage and frequency values of the grid itself are out of the range of values defined by the Distribution System Operator (DSO).
- **Adaptive protection.**  
Network changes recognition and automatic set of thresholds to guarantee protection and coordination in on-grid and off-grid conditions.

## AIR CIRCUIT-BREAKERS

# Formula Air

## Simplicity and safety, up to 50kA

Formula Air is an ideal solution for main installation requirements, from distribution switchboards to onboard compartments. This comprehensive range offers the most suitable solution for each specific set of requirements. Easy to use Formula Air products are also easy to order.

Possibility to change, on site, the orientation of the rear terminals from horizontal to vertical or vice versa which allows adaptability to accommodate last minutes changes busbar design.

Front terminals are available for breakers up to 1600A in fixed version to have switchboard with compact dimensions.

With High Mechanical and electrical life Formula Air circuit breakers offer high longevity to the installation.

The ACBs are available in 3 sizes up to 4000A with performance level up to 50kA which are equipped with Ek 1 and Ek 2 trip units.



### Ratings available

Frame	630A	800A	1000A	1250A	1600A	2000A	2500A	3200A	4000A
FA1	•	•	•	•	•				
FA2					•	•			
FA4							•	•	•

### Flexibility:

Rear power terminals can be rotated between horizontal and vertical position, easily on site. In alternative, the range offers front and spread terminals for different panel solutions

### Intuitive interfaces:

Clear icons on a wide LCD screen or LEDs indicating the circuit-breaker status, saving time to on site setting up and maintain

### Standardization:

All frames have common trip unit, and most common mechanical and electrical accessories, enabling stock reduction

### Fast accessorizing:

Plug-in installation, allowing up to 30% time saving

### Protection releases

Parameters	EK 1 - LI	EK1- LSIG	EK2-LSIG
Neutral protection	•	•	•
Switchable thermal memory	•	•	•
Graphical display with current metering			•
Closing on short-circuit (MCR)			•
Start-up function			•
Instantaneous earth fault (G-ANSI 50N)			•
Current unbalance protection			•
Watchdog function	•	•	•
Contact wear Indication			•
Display of No of operation			•
Display of Last Maintenance date			•
Zone Selectivity for S & G protections			•
Display of 20 Trip history & 100 events			•
Test function	•	•	•
Download breaker maintenance data from ACB	•	•	•

MOLDED CASE CIRCUIT-BREAKERS

## SACE Tmax XT

Break new ground



Break new ground simply means delivering value through the entire customer journey by leaving behind the traditional concept of circuit - breaker. The SACE Tmax XT range offers a unique customer experience that, sharing the same features and logics with the Emax 2 range, for the first time ever overcomes the differences between molded case and air circuit-breakers. The most advanced products designed to maximize data and connectivity, ease of use and installation, performance and protection, safety and reliability.

The SACE Tmax XT range offers higher performance, better protection and more precise metering than equivalent units, and can handle from 160 up to 1600A.

### Distinctive features



#### Data and connectivity

Plant management of the future – SACE Tmax XT sets standards in modern plant and energy management. Access, monitor and control information remotely, anywhere, at any time. Improving efficiency and saving energy.

#### Local connection and Remote communication

Commissioning and device setting have never been so easy thanks to the Bluetooth connectivity and the Ekip Connect software and several communication protocols available.

#### Cloud connectivity

Cloud connection is now possible to exploit the full service of ABB Ability™ Energy and Asset Management thanks to the Ekip Com HUB.



#### Ease of use and installation

Easy selection, one-fits-all accessories and intuitive design pave the way for fast upgrades and create values through the entire customer journey. Even for the most critical projects.



#### Performance and protection

Continuity of service and equipment protection – SACE Tmax XT sets standards when extreme breaking capacity is needed.

#### Electrical performances

SACE Tmax XT is designed and tested to meet any installation requirement, even the most critical ones.



#### Safety and reliability

Absolute attention to detail, with style from design to manufacturing SACE Tmax XT sets standards for edge technologies. Half a century of research and experience means top-level products that are ready to face future challenges.

# ArTuK Born certified

Fully checked and certified (IEC 60439-1 and IEC 61439-1 and 2 Standard) by an external independent organisation (Acea Lovag, CPRI & ERDA), the ArTu switchgear is a synonym of safety and quality. The certification is the fruit of severe tests carried out on the whole configuration, consisting of metalwork structures, circuit-breakers and busbar system.

The ArTu K series switchgear is ideal for primary distribution board, motor control center, power control center etc. upto 6300A with air and molded-case circuit-breakers and any internal segregations up to Form 4, and for floor-mounted secondary distribution switchgear with molded-case and modular circuit-breakers. The switchgear has been tested for Internal Arc (as per IEC 61641) and Seismic (as per IEC 60068).

## Smart Low Voltage switchboard

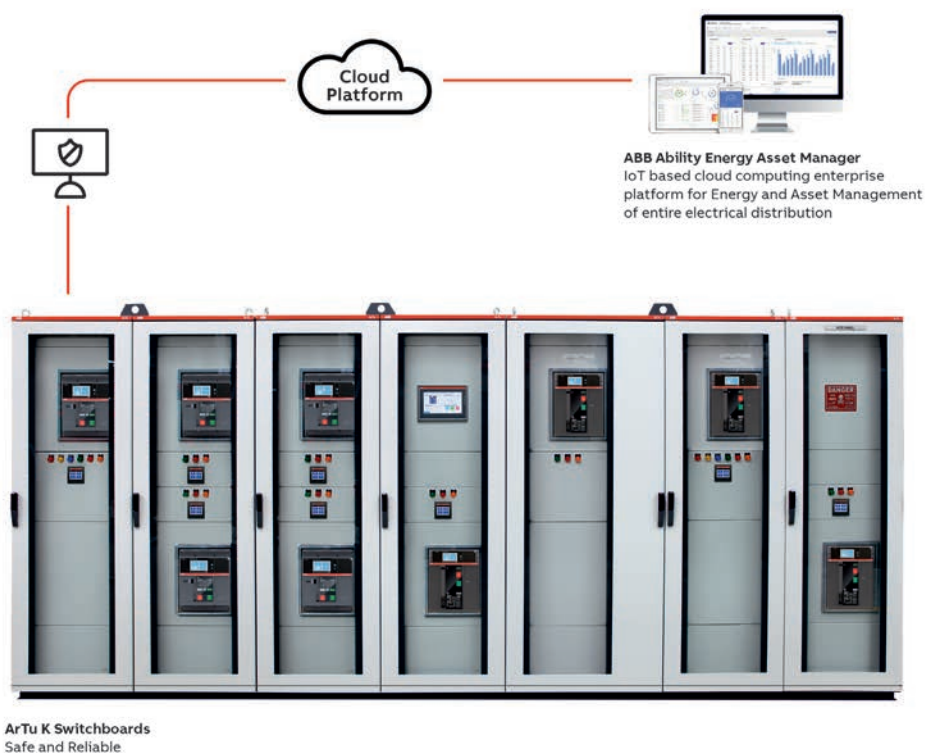

### The ArTu switchgear is noted for the following features:

- Integrated range of modular metalwork structures up to 6300 A with common accessories.
- Possibility of fulfilling all application requirements in terms of installation (floorstanding, modular and corner versions) and degree of protection (IP31, IP41, IP 42, IP54 & IP65).
- Maximum integration with modular apparatus and the molded-case and air circuit-breakers, so that additional drilling or adaptations are not required.
- Minimum switchgear assembly time, thanks to the simplicity of the kits, standardization of the small assembly items, self-supporting elements and the presence of clear reference points for assembly of the plates and panels – Segregations in kits up to Form 4.

The use and installation of the kits according to the instructions provided means that assembly and cabling times can be reduced to a minimum, for example, thanks to the reference points for positioning the panels and plates, and that respect of the insulation distances and the rated characteristics of the circuit-breakers are guaranteed.

# ABB Ability™ Energy and Asset Manager

## Understanding power and assets

**ABB Ability™ Energy and Asset Manager is a state-of-the-art cloud solution** that integrates energy and asset management in a single intuitive dashboard. Providing full remote visibility of asset and electrical-system behavior, ABB Ability™ Energy and Asset Manager provides insights that help you minimize cost and risk and maximize performance and safety across your operations. Want to get started now? Testing and purchasing Energy and Asset Manager is easy on the ABB Ability Marketplace™.

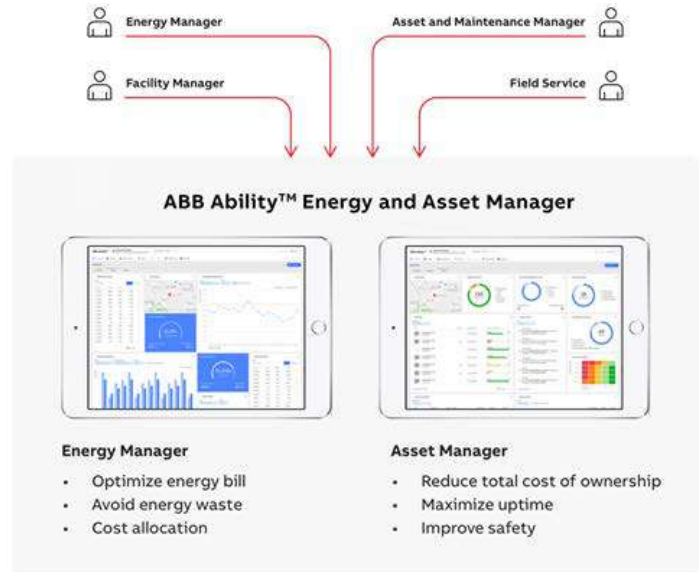

### Energy and Asset management made easy

The energy and asset management modules can be purchased separately or together, depending on your needs. Monitoring can also be segmented down to individual pieces of equipment and/or sub-systems-such as an elevator, a single HVAC system, or a production line.

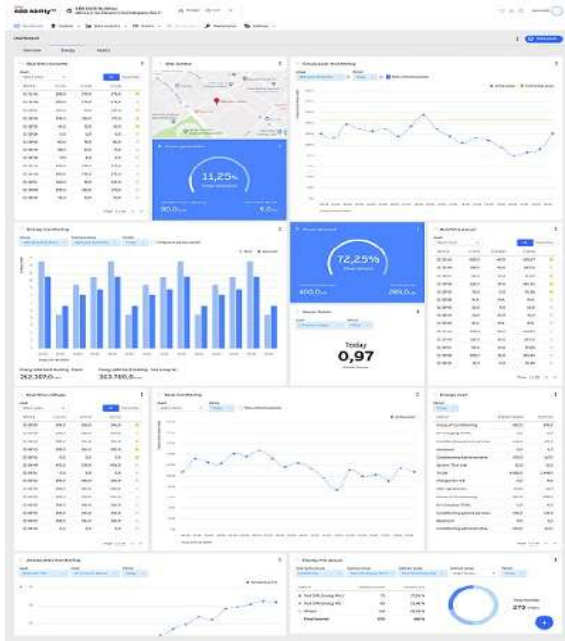

### ABB Ability™ Energy Manager

Energy efficiency has become essential to running cost-efficient operations. ABB Ability™ Energy Manager provides real-time understanding of your energy consumption and identifies areas of improvement. And it's scalable, from a single site to a multi-facility system with hundreds of users.



#### Monitor

Discover Site performance, supervise the electrical system and allocate costs.



#### Analyze

Schedule automatic data exports, improve the use of assets and take the right business decision.



#### Act

Set up alerts and notify to key personnel and remotely implement an effective efficiency strategy to achieve energy savings in a simple way.

# ABB Ability™ Asset Manager



ABB Ability™ Asset Manager sets a new benchmark for simplicity and flexibility in asset-performance management. It gives you the power of seeing and optimizing your site equipment behavior anytime, anywhere via an intuitive graphic interface, resulting in greater reliability and availability and minimized unplanned maintenance.



### Condition Monitoring

ABB Ability™ Asset Manager provides granular visibility of your asset behavior in real time for both LV and MV environments

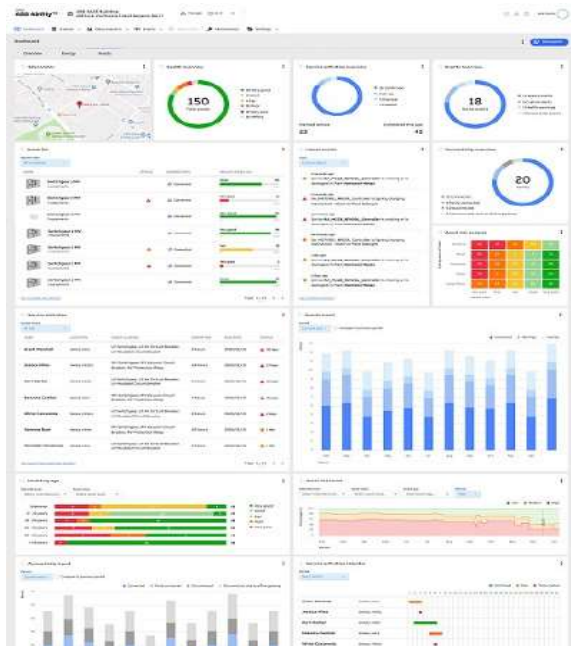

### Predictive Analytics

Detect potential faults through condition assessment, performance trends and pre-alarm notifications.



### Maintenance Planning

Root-cause analysis of asset condition enables predictive maintenance that significantly reduces unplanned downtime and operational costs.

## Lite panel One digital panel fits all



Lite Panel is the new switchboard HMI able to monitor and control until 28 electrical assets at the same time, directly connected in the on-premise communication network, showing their data as digital twins through predefined templates.

## Value proposition



### Safety

Monitoring and control the electrical assets, also with fault detections and diagnostics data check, far from the switchboard power sections reduce the risk of serious incidents.



### Energy efficiency

Supervision of assets status, energy and power quality from a unique panel improves the data collection efficiency with less 70% of time spent nearby electrical rooms and enables analytics to plan saving actions.



### Easy to install

The plug & play panel architecture saves more than 4 times the components and wirings compared to traditional market benchmarks.



### Optimum interface

Until 28 digital-twin devices are available from a single interface within the local secure network, so leveraging on the already present communication tag points.

# Architecture

## Truly plug & play

**Embedded solution with Ekip Com Hub**  
 Emax 2, Ekip UP and TruONE equipped with the new Ekip Com Hub establishes the cloud connection for the whole switchboard.

This dedicated cartridge-type communication module just needs to be inserted into the terminal box and connected to the internet.

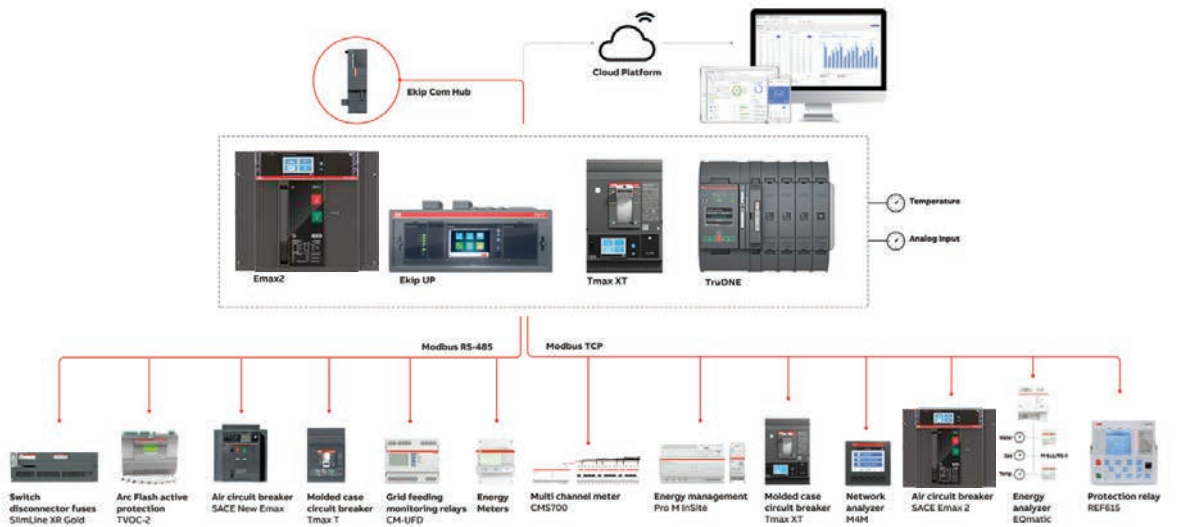

**External solution with ABB Ability™ Edge Industrial gateway**  
 The ABB Ability™ Edge Industrial gateway module can be mounted on DIN rail to collect data throughout the system. You can also connect sensors to measure environmental parameters (temperature, water, gas) via both

analog and digital I/O. ABB Ability™ Edge Industrial gateway has enhanced connectivity functionalities, providing Wi-Fi or 3G/4G connectivity.





ABB showcases a further evolution in the low-voltage distribution business, establishing a new benchmark in terms of simplicity and performance.

ABB Ability™ Energy and Asset Manager enables the collection of relevant information from the ABB devices installed in the low-voltage power distribution system.

These devices can be connected to the cloud-computing platform to share data with Emax 2 (equipped with Ekip Com Hub) or with ABB Ability™ Edge Industrial gateway via Modbus RS-485, Modbus TCP and Ekip Link.

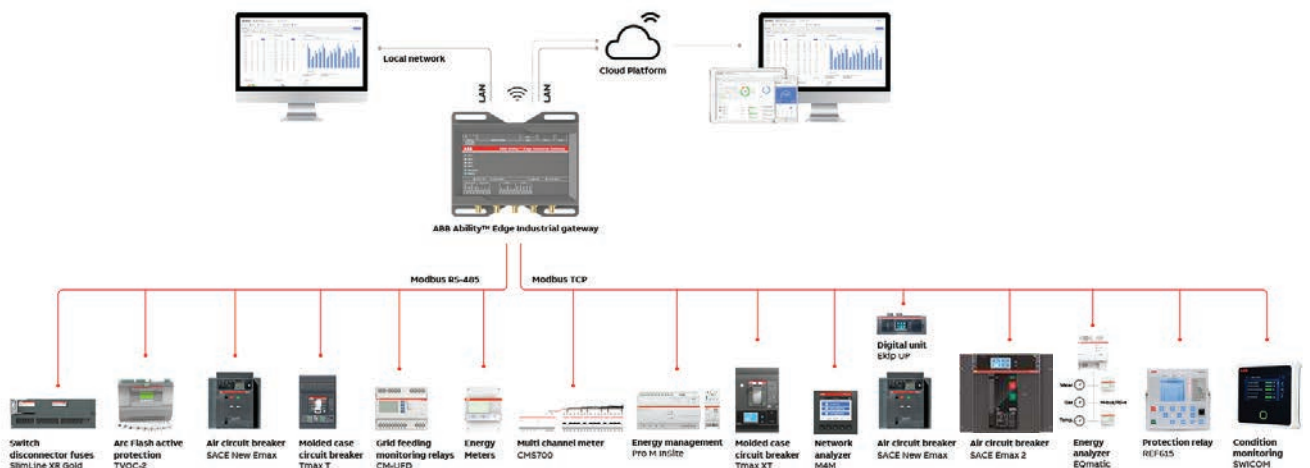
		INFORMATION									COMMUNICATION	
Family	Device	State	Current	Voltages	Power	Energy	Power factor	Power quality	Maintenance & Diagnostics	Load management	Analog or pulse/digital inputs	Protocol
Low voltage MCCB	Tmax XT	•	•	•	•	•	•	•	•	•	•	Modbus RS485, Modbus TCP, Ekip Com Hub
Low voltage ACB	Emax 2	•	•	•	•	•	•	•	•	•	•	Modbus RS485, Modbus TCP, Ekip Com Hub
Digital units	Ekip UP+	•	•	•	•	•	•	•		•	•	Modbus RS485, Modbus TCP, Ekip Com Hub
Low voltage switches and fusegear	TruONE ATS	•	•	•	•	•	•	•	•		•	Modbus RS485, Modbus TCP, Ekip Com Hub
	Slimline XR ITS 2.1	•	•	•	•	•	•	•	•			Modbus RS485
Digital inputs interface	Ekip signalling MODBUS TCP	•									•	Modbus TCP
Sub-Metering	EQ meters		•	•	•	•	•					Modbus RS485
Power meters	M4M		•	•	•	•	•	•				Modbus RS485, Modbus TCP
Energy management	System pro M compact® InSite	•	•	•	•	•	•	•		•	•	Modbus RS485, Modbus TCP
MV relays	615 Series	•	•	•	•	•	•	•	•	•	•	Modbus TCP
MV condition monitoring	SWICOM								•			Modbus TCP
And many others to come...		*Provided with dedicated accessories for communication and metering functions ** Only with ABB Ability EL gateway										

# ABB Formula DSP P1-P4

## Performance made simple



The new SACE FORMULA DSP family consists of four frames (P1, P2, P3 and P4) reaching up to 160A, 250A, 630A and 800A respectively. The four frames are available with thermal-magnetic trip units to cover the most common AC and DC fields. Availability of most requested accessories guarantees the possibility to fulfil the main applications needs.



### Easy to install

Click-in fixing for accessories to guarantee time saving and fast installations.



### Simplified selection

Availability of a short list of codes enables simplified product selection and easy ordering.



### Quality

ABB long experience in molded-case circuit breakers design is a guarantee of quality.



### Sustainability

Compliance with the international regulations of Product Materials and Environmental Health and Safety.



- Compliance to IEC 60947-2 standards
- Offering from 40A to 800A in 4 frame sizes
- Available upto 50kA performance levels (Icu = Ics)
- Circuit breakers for AC and DC applications
- Double insulation
- Isolation behaviour
- Positive operation
- Accessories covering the main standard applications and needs

### Power distribution protection

Field of application	Trip Unit	L – Overload Protection								I – Short-circuit Protection					
		Current Threshold								Trip Time		Current Threshold		Trip Time	
Power Distribution	TMD	70% to 100% x In								Fixed		Fixed		Fixed instantaneous	
Protection	TMA	70% to 100% x In								Fixed		70% to 100% x In		Fixed instantaneous	
	In [A]	40	63	80	100	125	160	200	250	320	400	630	800		
TMD	P1	•	•	•	•	•	•								
	P2							•	•						
TMA	P3									•	•	•			
	P4													•	

# The SACE Tmax XT range at a glance

The world of circuit breaking and circuit protection in your hands



**SACE Tmax XT1**

Small, reliable, versatile. Your reliable partner for all standard applications.

**At a glance:**

- Up to 160A
- For basic functionalities
- Dimensions 76.2x70x130 (WxDxH mm)
- Thermal-magnetic trip unit



**NEW**

**SACE Tmax XT2**

Compact yet powerful. It fits everywhere and is able to deal with all complex tasks.

**At a glance:**

- Up to 160A
- For heavy duty
- Dimensions 90x82.5x130 (WxDxH mm)
- Thermal-magnetic, Ekip Dip, Ekip Touch/Hi-Touch



**SACE Tmax XT3**

Small and experienced. For standard applications that need few efforts.

**At a glance:**

- Up to 250 A
- For basic functionalities
- Dimensions 105x70x150 (WxDxH mm)
- Thermal-magnetic trip unit



**NEW**

**SACE Tmax XT4**

A forward-thinking, multitasker. It finds solutions for all levels of complexity.

**At a glance:**

- Up to 250A
- For heavy duty
- Dimensions 105x82.5x160 (WxDxH mm)
- Thermal-magnetic, Ekip Dip, Ekip Touch/Hi-Touch



**NEW**

**SACE Tmax XT5**

Compact, extremely powerful and flexible. It shows the world what a circuit-breaker of the future can do, today.

**At a glance:**

- Up to 630A
- For heavy duty
- Dimensions 140x103x205 (WxDxH mm)
- Thermal-magnetic, Ekip Dip, Ekip Touch/Hi-Touch



**NEW**

**SACE Tmax XT6**

Built to last. It completes all assignments it has been entrusted with.

**At a glance:**

- Up to 1000A
- For basic functionalities
- Dimensions 210x103.5x268 (WxDxH mm)
- Thermal-magnetic, Ekip Dip



**NEW**

**SACE Tmax XT7 / XT7 M**

The ultimate choice. It deals with the most heavy-duty demands effortlessly.

**At a glance:**

- Up to 1600A
- For heavy duty
- Dimensions 210x166x268 (WxDxH mm)
- Ekip Dip, Ekip Touch/Hi-Touch

	Applications						Advanced functionalities	
	Distribution		Motor	Generator	Selectivity	Metering	Communication	ABB Ability Marketplace™
	DC	AC						
Touch		•	•	•	•	•	•	
Dip		•	•	•	•			
TM	•	•	•	•				

# Tmax circuit breakers

Type	Iu (40° C) [A]	Ue [V]		Category	Release	Icu (380 - 415 V AC) [kA]											
		AC	DC			16	25	36	50	70	85	100	120	150	200		
XT1	160	690	500	A	TMD/TMF MF/MA	B	C	N	S	H							
XT2	160	690	500	A	TMD/TMA MF/MA Ekip LS/I Ekip I Ekip LSI Ekip LIG Ekip LSIG Ekip M-I Ekip M-LIU Ekip M-LRIU Ekip N-LS/I			N	S	H			L	V			
XT3	250	690	500	A	MF/MA TMD TMG			N	S								
XT4	250	690	500	A	TMD/TMA MF/MA Ekip LS/I Ekip I Ekip LSI Ekip LIG Ekip LSIG Ekip E-LSIG Ekip M-LIU Ekip M-LRIU Ekip G-LS/I Ekip N-LS/I			N	S	H			L	V			
T5	400 630	690 1150	750 1000	B (400 A) A (630 A)	TMA (500 A) TMG (500 A) PR221DS PR222DS Ekip M			N	S	H			L	V			
T6	630 800 1000	690 1150	750 1000	B (630A - 800 A) A (1000 A)	TMA (800 A) PR221DS PR222DS Ekip M			N	S	H			L	V			
T7	800 1000 1250 1600	690		B	PR231/P PR232/P PR331/P PR332/P				S	H			L	V			

## Trip Units

### Thermal magnetic trip units

- MA - Magnetic only trip unit with adjustable magnetic thresholds for motor protection
- TMF - Fixed thermal and fixed magnetic for power distribution
- TMD - Adjustable thermal (70-100% of In) and fixed magnetic (10 x In) for power distribution
- TMA - Adjustable thermal (70-100% of In) and adjustable magnetic (5-10 of In) for power distribution
- TMG - Adjustable thermal (70-100% of In) and low fixed magnetic (3 x In) for generator protection

### Microprocessor based electronic trip units

Ekip LS/I or Ekip LSI	L = 0.40 - 1 of In	Ekip LIG	L = 0.40 - 1 of In	Ekip LSIG or Ekip E-LSIG	L = 0.4 - 1 of In	Ekip M-LIU	L = 0.4 - 1 of In	Ekip M-LRIU	L = 0.4 - 1 of In
	S = 1 - 10 of In		I = 1 - 10 of In		S = 0.6 - 10 of In		I = 6 - 13 of In		R = 3 - 9 of In
	I = 1 - 10 of In		G = 0.2 - 1 of In		I = 1.5 - 12 of In		U* = ON or OFF		I = 6 - 13 of In
					G = 0.2 - 1 of In				G = 0.2 - 1 of In
									U* = ON or OFF
PR221	L = 0.40 - 1 of In	PR222	L = 0.4 - 1 of In	PR231	L = 0.4 - 1 of In	PR331	L = 0.4 - 1 of In	PR331	L = 0.4 - 1 of In
	S = 1 - 10 of In		S = 0.6 - 10 of In		S = 1 - 10 of In		S = 0.6 - 10 of In		
	I = 1 - 10 of In		I = 1.5 - 12 of In		I = 1 - 12 of In		I = 1.5 - 15 of In		
			G = 0.2 - 1 of In						G = 0.2 - 1 of In

L = Overload S = Short circuit I = Instantaneous short circuit G = Earth fault

U = phase loss (U): With selector in ON position, circuit breaker trips if at least one current phase is lower than 0.1xIn and at least a second one higher than 0.25xIn;

Ekip N-LS/I: Neutral can be set in the OFF or ON positions, at 100% or at 160% of the phases;

Ekip G-LS/I: Neutral, in four-pole circuit-breakers, can be set in the OFF, ON positions at 50% or 100% of the phases;

Note: For detailed information about trip units, refer technical catalogue.

# Tmax power distribution circuit breakers

## XT1

Breaking capacity at 415VAC

	Icu	Ics (Icu)
B	18kA	100%
C	25kA	100%
N	36kA	100%
S	50kA	75%
H	70kA	50%

TMD			B		C		N	
Frame	In (A)	Poles	Ordering code	L.P.(₹)	Ordering code	L.P.(₹)	Ordering code	L.P.(₹)
XT1 160	16	3	1SDA066799R1	9,860	1SDA080825R1	10,960	1SDA080827R1	14,190
	20		1SDA066800R1		1SDA080826R1		1SDA080828R1	
	25		1SDA066801R1		1SDA067391R1		1SDA080829R1	
	32		1SDA066802R1		1SDA067392R1		1SDA067411R1	
	40		1SDA066803R1 ■		1SDA067393R1 ■		1SDA067412R1 ■	
	50		1SDA066804R1 ■		1SDA067394R1 ■		1SDA067413R1 ■	
	63		1SDA066805R1 ■		1SDA067395R1 ■		1SDA067414R1 ■	
	80		1SDA066806R1 ■		1SDA067396R1 ■		1SDA067415R1 ■	
	100		1SDA066807R1 ■		1SDA067397R1 ■		1SDA067416R1 ■	
	125		1SDA066808R1 ■		1SDA067398R1 ■		1SDA067417R1 ■	
	160	1SDA066809R1 ■	1SDA067399R1 ■	1SDA067418R1 ■				
	16	4	1SDA066810R1	13,720	1SDA080840R1	15,720	1SDA080842R1	18,160
	20		1SDA066811R1		1SDA080841R1		1SDA080843R1	
	25		1SDA066812R1		1SDA067400R1		1SDA080844R1 ■	
	32		1SDA066813R1 ■		1SDA067401R1 ■		1SDA067419R1 ■	
	40		1SDA066814R1 ■		1SDA067402R1 ■		1SDA067420R1 ■	
	50		1SDA066815R1		1SDA067403R1 ■		1SDA067421R1	
	63		1SDA066816R1 ■		1SDA067404R1 ■		1SDA067422R1 ■	
	80		1SDA066817R1 ■		1SDA067405R1 ■		1SDA067423R1 ■	
	100		1SDA066818R1 ■		1SDA067406R1 ■		1SDA067424R1 ■	
125	1SDA066888R1 ■		1SDA067409R1 ■		1SDA067427R1 ■			
160	1SDA066821R1 ■	1SDA067410R1 ■	1SDA067428R1 ■					

TMD / TMF*			S		H	
Frame	In (A)	Poles	Ordering code	L.P.(₹)	Ordering code	L.P.(₹)
XT1 160	16	3	1SDA080830R1*	14,790	1SDA080835R1*	17,560
	20		1SDA080831R1*		1SDA080836R1*	
	25		1SDA080832R1		1SDA080837R1	
	32		1SDA080833R1 ■		1SDA080838R1	
	40		1SDA080834R1 ■		1SDA080839R1	
	50		1SDA067431R1		1SDA067449R1	
	63		1SDA067432R1 ■		1SDA067450R1	
	80		1SDA067433R1 ■		1SDA067451R1	
	100		1SDA067434R1 ■		1SDA067452R1	
	125		1SDA067435R1 ■		1SDA067453R1	
	160	1SDA067436R1 ■	1SDA067454R1			
	16	4	1SDA080845R1*	21,620	1SDA080850R1*	24,380
	20		1SDA080846R1*		1SDA080851R1*	
	25		1SDA080847R1		1SDA080852R1	
	32		1SDA080848R1		1SDA080853R1	
	40		1SDA080849R1		1SDA080854R1	
	50		1SDA067439R1		1SDA067457R1	
	63		1SDA067440R1 ■		1SDA067458R1	
	80		1SDA067441R1		1SDA067459R1	
	100		1SDA067442R1 ■		1SDA067460R1	
125	1SDA067445R1 ■		1SDA067463R1			
160	1SDA067446R1	1SDA067464R1				



■ Stock items

\*TMF trip unit

# Tmax power distribution circuit breakers

Protection: TMD/TMA-3Pole

## XT3

Breaking capacity at 415VAC

	Icu	Ics(Icu)
N	36kA	75%
S	50kA	50%

TMD			N		S	
Frame	In (A)	Poles	Ordering code	L.P.(₹)	Ordering code	L.P.(₹)
XT3 250	200	3	1SDA068058R1 ■	27,240	1SDA068220R1 ■	30,160
	250		1SDA068059R1 ■	31,620	1SDA068221R1 ■	33,540

## XT2/XT4/T5/T6

Breaking capacity at 415VAC

	Icu	Ics (Icu)
N	36kA	100%
S	50kA	100%
H	70kA	100%



TMD / TMA*		N		S		H			
Frame	In (A)	Poles	Ordering code	L.P.(₹)	Ordering code	L.P.(₹)	Ordering code	L.P.(₹)	
XT2160	1.6	3	1SDA067000R1	17,340	1SDA067540R1	19,190	1SDA067584R1	26,040	
	2		1SDA067001R1		1SDA067541R1		1SDA067585R1		
	2.5		1SDA067002R1		1SDA067542R1		1SDA067586R1		
	3.2		1SDA067003R1		1SDA067543R1		1SDA067587R1		
	4		1SDA067004R1		1SDA067544R1		1SDA067588R1		
	5		1SDA067005R1		1SDA067545R1		1SDA067589R1		
	6.3		1SDA067006R1		1SDA067546R1		1SDA067590R1		
	8		1SDA067007R1		1SDA067547R1		1SDA067591R1		
	10		1SDA067008R1		1SDA067548R1 ■		1SDA067592R1		
	12.5		1SDA067009R1		1SDA067549R1		1SDA067593R1		
	16		1SDA067010R1 ■		1SDA067550R1 ■		1SDA067594R1		
	20		1SDA067011R1 ■		1SDA067551R1		1SDA067595R1		
	25		1SDA067012R1		1SDA067552R1 ■		1SDA067596R1		
	32		1SDA067013R1 ■		1SDA067553R1 ■		1SDA067597R1		
	40		1SDA067014R1 ■		1SDA067554R1 ■		1SDA067598R1		23,540
	50		1SDA067015R1		1SDA067555R1 ■		1SDA067599R1		
63	1SDA067016R1 ■	1SDA067556R1 ■	1SDA067600R1 ■						
80	1SDA067017R1	1SDA067557R1 ■	1SDA067601R1						
100	1SDA067018R1 ■	1SDA067558R1 ■	1SDA067602R1 ■						
125	1SDA067019R1 ■	20,940	1SDA067559R1 ■	26,730	1SDA067603R1 ■	43,570			
160	1SDA067020R1 ■	24,060	1SDA067560R1 ■	28,250	1SDA067604R1 ■	44,030			
XT4 250	200	1SDA068090R1 ■	31,560	1SDA068310R1 ■	36,150	1SDA068343R1	48,910		
	225	1SDA068091R1	33,100	1SDA068311R1	37,320	1SDA068344R1	50,170		
	250	1SDA068092R1 ■	36,150	1SDA068312R1 ■	41,530	1SDA068345R1 ■	51,480		
T5	320	1SDA054436R1 ■	37,600	1SDA054440R1 ■	43,550	1SDA054444R1 ■	52,490		
	400	1SDA054437R1 ■		1SDA054441R1 ■		1SDA054445R1 ■			
	500	1SDA054456R1 ■		1SDA054461R1 ■		1SDA054465R1		68,470	
T6	630	1SDA060202R1 ■	55,760	1SDA060204R1 ■	59,500	1SDA060206R1	72,590		
	800	1SDA060214R1 ■	71,820	1SDA060216R1 ■	78,750	1SDA060218R1 ■	81,400		

\* 40 A onwards

■ Stock items

# Tmax power distribution circuit breakers

Protection: TMD/TMA-4Pole

## XT3

Breaking capacity at 415VAC

	Icu	Ics(Icu)
N	36kA	75%
S	50kA	50%

TMD			N		S	
Frame	In (A)	Poles	Ordering code	L.P.(₹)	Ordering code	L.P.(₹)
XT3 250	200	4	1SDA068069R1 ■	29,970	1SDA068231R1 ■	35,030
	250		1SDA068070R1 ■	35,770	1SDA068232R1 ■	38,440

## XT2/XT4/T5/T6

Breaking capacity at 415VAC

	Icu	Ics (Icu)
N	36kA	100%
S	50kA	100%
H	70kA	100%



TMD / TMA*			N		S		H		
Frame	In (A)	Poles	Ordering code	L.P.(₹)	Ordering code	L.P.(₹)	Ordering code	L.P.(₹)	
XT2160	1.6	4	1SDA067021R1	22,500	1SDA067561R1	24,330	1SDA067605R1	37,570	
	2		1SDA067022R1		1SDA067562R1		1SDA067606R1		
	2.5		1SDA067023R1		1SDA067563R1		1SDA067607R1		
	3.2		1SDA067024R1		1SDA067564R1		1SDA067608R1		
	4		1SDA067025R1		1SDA067565R1		1SDA067609R1		
	5		1SDA067026R1		1SDA067566R1		1SDA067610R1		
	6.3		1SDA067027R1		1SDA067567R1		1SDA067611R1		
	8		1SDA067028R1		1SDA067568R1		1SDA067612R1		
	10		1SDA067029R1		1SDA067569R1		1SDA067613R1		
	12.5		1SDA067030R1		1SDA067570R1		1SDA067614R1		
	16		1SDA067031R1		1SDA067571R1		1SDA067615R1		
	20		1SDA067032R1		1SDA067572R1		1SDA067616R1		
	25		1SDA067033R1		1SDA067573R1		1SDA067617R1		
	32		1SDA067034R1		1SDA067574R1 ■		1SDA067618R1		
	40		1SDA067035R1		1SDA067575R1		1SDA067619R1		30,190
	50		1SDA067036R1		1SDA067576R1		1SDA067620R1		
	63		1SDA067037R1 ■		1SDA067577R1 ■		1SDA067621R1		
80	1SDA067038R1	1SDA067578R1	1SDA067622R1						
100	1SDA067039R1 ■	1SDA067579R1 ■	1SDA067623R1						
XT4 250	125	1SDA067042R1 ■	27,260	1SDA067582R1 ■	32,190	1SDA067626R1	44,530		
	160	1SDA067043R1 ■	30,570	1SDA067583R1 ■	33,920	1SDA067627R1	47,220		
	200	1SDA068109R1 ■	37,320	1SDA068329R1 ■	46,030	1SDA068362R1	58,230		
	225	1SDA068110R1	37,680	1SDA068330R1	47,490	1SDA068363R1	58,890		
250	1SDA068111R1 ■	39,600	1SDA068331R1 ■	1SDA068364R1		59,180			
T5	320	1SDA054477R1 ■	47,200	1SDA054479R1 ■	54,090	1SDA054481R1	61,930		
	400	1SDA054478R1 ■		1SDA054480R1 ■		1SDA054482R1 ■			
	500	1SDA054487R1 ■		1SDA054489R1 ■		1SDA054491R1 ■		80,560	
T6	630	1SDA060210R1 ■	66,770	1SDA060211R1 ■	75,660	1SDA060212R1	83,650		
	800	1SDA060222R1 ■	76,650	1SDA060223R1 ■	90,970	1SDA060224R1	94,940		

\* 40 A onwards

■ Stock items

# Tmax power distribution circuit breakers

Protection: LS/I

## XT2/XT4/T5/T6

Breaking capacity at 415VAC

	Icu	Ics (Icu)
N	36kA	100%
S	50kA	100%
H	70kA	100%



### Protection : LS/I

			N		S		H	
Frame	In (A)	Poles	Ordering code	L.P. (₹)	Ordering code	L.P. (₹)	Ordering code	L.P. (₹)
XT2 160	10	3	1SDA067054R1	28,060	1SDA067800R1	32,350	1SDA067857R1	36,630
	25		1SDA067055R1		1SDA067801R1		1SDA067858R1	
	63		1SDA067056R1	24,190	1SDA067802R1	27,980	1SDA067859R1	35,860
	100		1SDA067057R1		1SDA067803R1		1SDA067860R1	
	160		1SDA067058R1		1SDA067804R1		1SDA067861R1	
XT4 250	250	1SDA068126R1	38,790	1SDA068475R1	44,280	1SDA068515R1	50,680	
T5 400	400	1SDA054317R1	58,340	1SDA054333R1	59,880	1SDA054349R1	68,300	
T5 630	630	1SDA054396R1	61,660	1SDA054404R1	62,060	1SDA054412R1	72,610	
T6 800	800	1SDA060268R1	75,960	1SDA060278R1	84,200	1SDA060289R1	1,01,480	
T6 1000*	1000	1SDA060537R1	1,16,770	1SDA060547R1	1,25,970	1SDA060561R1	1,46,180	

Frame	In (A)	Poles	Ordering code	L.P. (₹)	Ordering code	L.P. (₹)	Ordering code	L.P. (₹)
XT2 160	10	4	1SDA067090R1	34,090	1SDA067833R1	40,080	1SDA067890R1	44,820
	25		1SDA067091R1		1SDA067834R1		1SDA067891R1	
	63		1SDA067092R1	29,650	1SDA067835R1	38,970	1SDA067892R1	44,720
	100		1SDA067093R1		1SDA067836R1		1SDA067893R1	
	160		1SDA067095R1		1SDA067838R1		1SDA067895R1	
XT4 250	250	1SDA068147R1	54,270	1SDA068495R1	58,130	1SDA068535R1	74,580	
T5 400	400	1SDA054325R1	64,440	1SDA054341R1	78,130	1SDA054357R1	89,880	
T5 630	630	1SDA054400R1	76,600	1SDA054408R1	79,970	1SDA054416R1	108,050	
T6 800	800	1SDA060273R1	80,640	1SDA060283R1	1,05,130	1SDA060294R1	1,28,190	
T6 1000*	1000	1SDA060542R1	1,56,580	1SDA060556R1	1,75,000	1SDA060566R1	2,12,980	

Note: XT2/XT4 with Ekip LS/I release ; T5-T6 with PR221 LS/I release  
 \*Extended front (EF) terminals are supplied as standard in T6 1000A MCCB

## MCCBs with Overload, Short circuit and Earth Fault Protections XT2/XT4

Protection: LIG

Protection functions	Threshold
Overload "L" Protection	0.4...1 x In in steps of 0.04
Inst. Short-circuit "I" Protection	OFF - 1...10 x In
Earth Fault "G" Protection	OFF - 0.2 to 1 x In

Ekip LIG		N Version (Icu=Ics=36kA @ 415 V AC)		S Version (Icu=Ics=50kA @ 415 V AC)		
Frame	Poles	In (A)	Ordering Code	L.P.(₹)	Ordering Code	L.P.(₹)
XT2 160	3	63	1SDA100012R1 ■	34,670	1SDA100042R1 ■	36,510
		100	1SDA100013R1 ■		1SDA100043R1 ■	
		160	1SDA100014R1 ■	40,340	1SDA100044R1 ■	43,030
XT4 250		250	1SDA100185R1 ■	42,420	1SDA100215R1 ■	44,810
XT2 160	4	63	1SDA100027R1 ■	44,860	1SDA100057R1 ■	47,240
		100	1SDA100028R1 ■		1SDA100058R1 ■	
		160	1SDA100029R1 ■	52,230	1SDA100059R1 ■	55,730
XT4 250		250	1SDA100200R1 ■	54,910	1SDA100230R1 ■	58,050

■ Stock items



# Tmax power distribution circuit breakers

Protection: LSIG

## XT2/XT4/T5/T6

Breaking capacity at 415VAC

	Icu	Ics (Icu)
N	36kA	100%
S	50kA	100%
H	70kA	100%



### Ekip LSIG/XT2-XT4 Ekip LSIG/T5/T6 PR222DS/P-LSIG

Frame	In (A)	Poles	N		S		H	
			Ordering code	L.P. (₹)	Ordering code	L.P. (₹)	Ordering code	L.P. (₹)
XT2 160	10	3	1SDA067072R1	50,050	1SDA067815R1	53,560	1SDA067872R1	65,590
	25		1SDA067073R1		1SDA067816R1 ■		1SDA067873R1	
	63		1SDA067074R1 ■	51,870	1SDA067817R1 ■	52,520	1SDA067874R1	59,500
	100		1SDA067075R1 ■		1SDA067818R1 ■		1SDA067875R1	
	160		1SDA067076R1 ■		1SDA067819R1 ■		1SDA067876R1	
XT4 250	250	1SDA068141R1 ■	63,270	1SDA068490R1 ■	65,570	1SDA068530R1 ■	69,280	
T5 400	400	1SDA054323R1 ■	77,290	1SDA054339R1 ■	82,870	1SDA054355R1	99,710	
T5 630	630	1SDA054399R1 ■	87,600	1SDA054407R1 ■	90,350	1SDA054415R1 ■	1,03,050	
T6 800	800	1SDA060271R1 ■	1,12,190	1SDA060281R1 ■	1,18,490	1SDA060292R1	1,34,850	
T6 1000*	1000	1SDA060540R1	1,52,000	1SDA060554R1 ■	1,68,640	1SDA060564R1	1,93,240	

Note : Consider ordering "Ekip Com" for MODBUS communication for XT2 and XT4 frames only (Refer page no 36)

\* For communication capable MCCBs please contact nearest branch office

### Ekip LSIG/XT2-XT4 Ekip LSIG/T5/T6 PR222DS/P-LSIG

Frame	In (A)	Poles	N		S		H	
			Ordering code	L.P. (₹)	Ordering code	L.P. (₹)	Ordering code	L.P. (₹)
XT2 160	10	4	1SDA067108R1	59,850	1SDA067851R1	63,530	1SDA067908R1	77,450
	25		1SDA067109R1		1SDA067852R1		1SDA067909R1	
	63		1SDA067110R1 ■	59,950	1SDA067853R1 ■	62,150	1SDA067910R1	70,940
	100		1SDA067111R1 ■		1SDA067854R1 ■		1SDA067911R1	
	160		1SDA067113R1 ■		1SDA067856R1 ■		1SDA067913R1	
XT4 250	250	1SDA068162R1 ■	79,950	1SDA068510R1 ■	77,680	1SDA068550R1	97,950	
T5 400	400	1SDA054331R1 ■	86,820	1SDA054347R1 ■	95,460	1SDA054363R1	1,24,400	
T5 630	630	1SDA054403R1 ■	1,02,170	1SDA054411R1 ■	1,10,800	1SDA054419R1	1,41,250	
T6 800	800	1SDA060276R1 ■	1,25,720	1SDA060286R1 ■	1,36,440	1SDA060297R1	1,70,860	
T6 1000*	1000	1SDA060545R1 ■	1,94,840	1SDA060559R1	2,01,410	1SDA060569R1	2,44,900	

Note: \*Extended front (EF) terminals are supplied as standard in T6 1000A MCCB

■ Stock items

# Tmax power distribution circuit breakers

## T7

### Breaking capacity at 415VAC

	Icu	Ics (Icu)
S	50kA	100%
H	70kA	100%

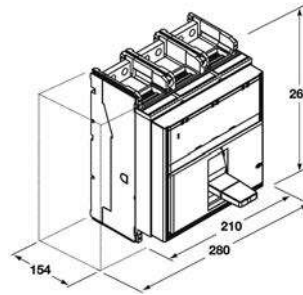

### T7 1250/1600

#### PR231/P LS/I

Frame	Trip unit	In (A)	Poles
T7	PR231/P LS/I	1250	3
		1600	
		1250	4
		1600	
	PR331/P LSIG	1250	3
		1600	
		1250	4
		1600	

S

Ordering code	L.P. (₹)
1SDA062866R1	Upon request
1SDA062994R1 ■	
1SDA062874R1 ■	
1SDA063002R1	
1SDA062868R1 ■	Upon request
1SDA062996R1	
1SDA062876R1	
1SDA063004R1	

H

Ordering code	L.P. (₹)
1SDA062898R1	Upon request
1SDA063026R1	
1SDA062906R1	
1SDA063034R1	
1SDA062900R1	Upon request
1SDA063028R1	
1SDA062908R1	
1SDA063036R1	

S

Frame	Trip unit	In (A)	Poles
T7M	PR231/P LS/I	1250	3
		1600	
		1250	4
		1600	
	PR331/P LSIG	1250	3
		1600	
		1250	4
		1600	

Ordering code	L.P. (₹)
1SDA062882R1	Upon request
1SDA063010R1	
1SDA062890R1	
1SDA063018R1	
1SDA062884R1	Upon request
1SDA063012R1	
1SDA062892R1	
1SDA063020R1	

H

Ordering code	L.P. (₹)
1SDA062914R1	Upon request
1SDA063042R1	
1SDA062922R1	
1SDA063050R1	
1SDA062916R1	Upon request
1SDA063044R1	
1SDA062924R1	
1SDA063052R1	

■ Stock items

# Tmax motor protection circuit breakers

Characteristics of circuit-breakers for protecting motors in three pole versions.

## Tmax Motor Protection Trip units

### > Magnetic trip units:

Frame	Protection	Range
XT2 160	MF ( $I_n \leq 12.5A$ )	14 x $I_n$
	MA ( $12.5A < I_n \leq 160$ )	6..14 x $I_n$
XT3 250	MA	6..12 x $I_n$
XT4 250	MA	5..10 x $I_n$

MF – Magnetic fix

MA- Magnetic Adjustable

### > Microprocessor trip units:

o Only Short circuit protection release

XT2/XT4		T5/T6		T7/T7M	
<b>Ekip M-I</b>	I = 6 - 14 of $I_n$	<b>PR221 DS-I</b>	I = 1 - 10 of $I_n$	<b>PR231P-I</b>	I = 1 - 10 of $I_n$

o Advanced Motor protection release

XT2/XT4		XT2/XT4/T5/T6	
<b>Ekip M-LIU</b>	L = 0.4 - 1 of $I_n$	<b>Ekip M-LRIU</b>	L = 0.4 - 1 of $I_n$
	I = 6 - 13 of $I_n$		R = 3 - 9 of $I_n$
	U* = ON or OFF		I = 6 - 13 of $I_n$
			G = 0.2 - 1 of $I_n$
			U* = ON or OFF

L = Overload; R = Protection against rotor blockage; I = Instantaneous short circuit; G = Earth fault

U = phase loss (U): With selector in ON position, circuit breaker trips if at least one current phase is lower than  $0.1I_n$  and at least a second one higher than  $0.25I_n$ .



# Tmax motor protection circuit breakers

Advantages of Ekip M-LRIU protection unit:

### Duty mode setting (Normal/Heavy):

- Normal duty mode requires use of a circuit-breaker and a contactor. In the case of tripping, the Ekip M-LRIU release commands the opening of the contactor via PR212/CI;
- Heavy duty mode foresees circuit-breaker opening for all overcurrent conditions, and just the function of motor operation is entrusted to the contactor

### PTC protection setting:

- PTC: this protection, monitors the temperature inside the protected motor by means of a PTC sensor.

❖ ABB solutions for starting, switching and protection of three-phase asynchronous motors:

- o A traditional system
- o A system of integrated protection

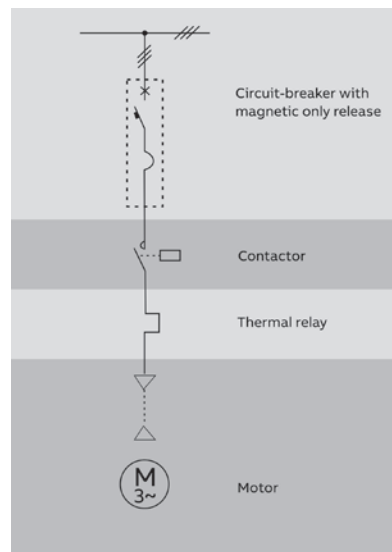

Traditional System

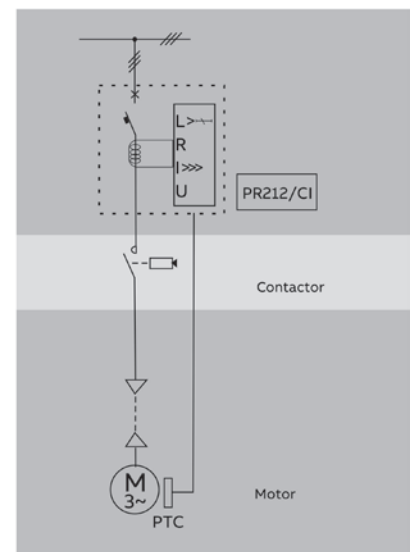

System of integrated protection

# Tmax motor distribution circuit breakers

Protection: Magnetic only and Microprocessor based short circuit protection MCCBs

## XT2/XT4/T5/T6

Breaking capacity at 415VAC

	Icu	Ics (Icu)
N	36kA	100%
S	50kA	100%
H	70kA	100%

MF/MA\*

MF/MA*			N		S		H	
In (A)	In (A)	Poles	Ordering code	L.P. (₹)	Ordering code	L.P. (₹)	Ordering code	L.P. (₹)
XT2 160	1	3	1SDA067044R1	17,000	1SDA067760R1	18,350	1SDA067770R1	20,610
	2		1SDA067045R1		1SDA067761R1		1SDA067771R1	
	4		1SDA067046R1		1SDA067762R1		1SDA067772R1	
	8.5		1SDA067047R1		1SDA067763R1 ■		1SDA067773R1	
	12.5		1SDA067048R1 ■		1SDA067764R1 ■		1SDA067774R1	
	20		1SDA067049R1 ■		1SDA067765R1 ■		1SDA067775R1	
	32		1SDA067050R1 ■		1SDA067766R1 ■		1SDA067776R1	
	52		1SDA067051R1 ■		1SDA067767R1 ■		1SDA067777R1	
	80		1SDA067052R1 ■		1SDA067768R1 ■		1SDA067778R1	
	100		1SDA067053R1 ■		1SDA067769R1 ■		1SDA067779R1	
XT4 250	160	3	1SDA076529R1	24,490	1SDA076530R1 ■	26,720	1SDA076535R1	34,090
	200		1SDA068121R1	42,150	1SDA068440R1 ■	45,840	1SDA068450R1	55,510

\* 20 amps onwards

## XT3

Breaking capacity at 415VAC

	Icu	Ics (Icu)
N	36KA	75%
S	50KA	50%

MA

MA			N		S	
Frame	In (A)	Poles	Ordering code	L.P. (₹)	Ordering code	L.P. (₹)
XT3 250	100	3	1SDA068071R1	20,620	1SDA068279R1	21,430
	125		1SDA068072R1		1SDA068280R1	
	160		1SDA068073R1		1SDA068281R1	
	200		1SDA068074R1		1SDA068282R1 ■	

## XT2/XT4/T5/T6

Ekip M-I

Ekip M-I			N		S		H	
Frame	Trip unit	In (A) Poles	Ordering code	L.P. (₹)	Ordering code	L.P. (₹)	Ordering code	L.P. (₹)
XT2 160	Ekip M-I	20	1SDA067086R1	23,000	1SDA067829R1	27,520	1SDA067886R1	29,670
		32	1SDA067087R1		1SDA067830R1		1SDA067887R1	
		52	1SDA067088R1		1SDA067831R1		1SDA067888R1	
		100	1SDA067089R1		1SDA067832R1		1SDA067889R1	
		160	1SDA067063R1		1SDA067809R1		1SDA067866R1	
XT4 250	Ekip M-I	250	1SDA068131R1 ■	43,460	1SDA068480R1 ■	47,140	1SDA068520R1	56,400
		400	1SDA054319R1	48,640	1SDA054335R1 ■	53,750	1SDA054351R1	65,600
T5	PR221 DS-I	630	1SDA054397R1 ■	51,800	1SDA054405R1 ■	58,450	1SDA054413R1	69,760
		800	1SDA060269R1	84,190	1SDA060279R1	94,300	1SDA060290R1	1,15,990
T6	PR221 DS-I	1000	1SDA060538R1	1,28,880	1SDA060548R1	1,39,020	1SDA060562R1	1,77,700

■ Stock items

# Tmax motor protection circuit breakers

## Advanced Motor Protection MCCBs

### T5/T6

Breaking capacity at 415VAC

	Icu	Ics (Icu)
N	36kA	100%
S	50kA	100%
H	70kA	100%



#### T5

#### Ekip M-LRIU

Frame	Trip unit	In (A)	Poles	N		S		H	
				Ordering code	L.P.(₹)	Ordering code	L.P.(₹)	Ordering code	L.P.(₹)
T5	Ekip M-LRIU	320	3	1SDA054551R1	79,660	1SDA054553R1	89,190		
		400	3	1SDA064157R1		1SDA064158R1			
T6		630	3	1SDA060311R1	1,11,500	1SDA060312R1	1,21,760	1SDA060313R1	1,41,200

# Tmax switch disconnectors



SD Frame	In(A)	Icw kA (1s)	Poles	Ordering code	L.P.(₹)	Poles	Ordering code	L.P.(₹)
XT1D	160	2	3	1SDA068208R1	12,060	4	1SDA068209R1	17,820
XT3D	250	3		1SDA068210R1	26,480		1SDA068211R1	31,640
XT4D	250	3.6		1SDA068212R1	30,210		1SDA068213R1	40,030
T5D	400	3.6		1SDA054599R1	38,470		1SDA054600R1	48,780
T5D	500	3.6		1SDA054601R1	46,770		1SDA054602R1	59,530
T6D	630	15		1SDA060343R1	52,870		1SDA060344R1	63,510
T6D	800	15		1SDA060345R1	58,380		1SDA060346R1	95,160
T6D	1000	15		1SDA060594R1	1,01,460		1SDA060595R1	1,26,660
T7D	1000	20		1SDA062032R1			1SDA062033R1	
T7D	1250	20		1SDA062036R1			1SDA062037R1	
T7D	1600	20		1SDA062040R1			1SDA062041R1	
T7D M	1000	20		1SDA062034R1	Upon request		1SDA062035R1	Upon request
T7D M	1250	20	1SDA062038R1		1SDA062039R1			
T7D M	1600	20	1SDA062042R1		1SDA062043R1			

# Tmax accessories



## Accessories for Tmax MCCBs

### Extended spreaded terminals - ES

Frame	Kit ES 6 pcs	L.P. (₹)	Kit ES 8 pcs	L.P. (₹)
XT1	1SDA066891R1 ■	2,620	1SDA066892R1 ■	3,500
XT2	1SDA066895R1 ■	3,560	1SDA066896R1 ■	4,330
XT3	1SDA066899R1 ■	3,820	1SDA066900R1 ■	4,870
XT4	1SDA066903R1 ■	4,400	1SDA066904R1 ■	5,520
T5	1SDA055038R1 ■	6,270	1SDA055039R1 ■	8,310

Note: Phase barrier supplied as standard with above copper spreaders.

### Separator - PB

Frame	Description	3 P - 4 pcs	L.P. (₹)	4 P - 6 pcs	L.P. (₹)
XT1-XT3	PB 100mm XT1-XT3	1SDA066676R1	1,060	1SDA066681R1	1,560
	PB 200mm XT1-XT3	1SDA066678R1	1,400	1SDA066683R1	2,040
XT2-XT4	PB 100mm XT2-XT4	1SDA066675R1	1,190	1SDA066680R1	1,780
	PB 200mm XT2-XT4	1SDA066677R1 ■	1,780	1SDA066682R1	2,600
	PB100mm T4-5-T7-A3	1SDA054970R1	1,470	1SDA054971R1	2,100
	PB100 - Low T4, T5	1SYN850207R0001	1,570	1SYN850210R0001 ■	2,180

Note: For T5 630A contact the nearest sales office

### Rotary handle operating mechanism



Frame	RHD	L.P. (₹)	RHE	L.P. (₹)
XT1-XT3 F/P	1SDA066475R1 ■	2,470	1SDA082810R1 ■*	2,270
XT1-XT3 F/P			1SDA066479R1#	2,580
XT2-XT4 F/P	1SDA069053R1 ■	2,940	1SDA082811R1 ■*	2,990
XT2-XT4 F/P			1SDA069055R1#	3,310
XT2-XT4 W	1SDA066476R1	2,940	1SDA066480R1 ■	3,310
XT2-XT4 F/P-Left Lateral			1SDA069058R1	5,270
XT2-XT4 F/P-Right Lateral			1SDA069060R1	5,200
T4-T5 F/P	1SDA054926R1 ■	5,180	1SDA070447R1 ■	4,800
T4-T5 W	1SDA054928R1	5,740	1SDA054933R1 ■	8,720
T6 F	1SDA060405R1 ■	7,070	1SDA060409R1 ■	9,130
T6 W	1SDA060407R1	8,890	1SDA060411R1	10,590
T7 F/P	1SDA062120R1	Upon request	1SDA062122R1 ■	Upon request

Note:- F/P: Fixed/Plug-in ; W: Withdrawable

\* RHE with 250mm rod

# RHE with 500mm rod

### Service releases

#### Shunt opening release - SOR

Frame	Description	Uncabled	L.P. (₹)	Cabled	L.P. (₹)
XT1... XT4	24-30 V AC/DC F/P	1SDA066314R1 ■	3,230	1SDA066322R1	4,910
	220...240 V ac-220...250 V DC F/P	1SDA066317R1 ■		1SDA066325R1	
	380-440 V ac F/P	1SDA066318R1		1SDA066326R1	
	24-30 V AC/DC W	-	1SDA066329R1	5,740	
	220...240 V ac-220...250 V DC W	-	1SDA066332R1		
	380-440 V AC W	-	1SDA066333R1		
T5-T6	SOR 24V AC/DC	1SDA054863R1	4,860	1SDA054870R1	8,550
	SOR 220...240V AC-220...250V DC	1SDA054866R1		1SDA054873R1 ■	
	SOR 380...440V AC	1SDA054867R1		1SDA054874R1	
	SOR 24V AC/DC	1SDA062065R1		-	
T7-T7M-X1	SOR 220...240V AC/DC	1SDA063548R1	Upon Request	-	
	SOR 415...440V AC	1SDA062072R1		-	

Note: For T7 / T7M in Withdrawable version sliding contact blocks for fixed and moving parts are necessary.

F/P: Fixed/Plug-in ; W: Withdrawable

■ Stock items

# Tmax accessories



Under voltage release - UVR						
Frame	Description	Uncabled	L.P. (₹)	Cabled	L.P. (₹)	
XT1....XT4	24-30 VAC/DC F/P	1SDA066389R1	6,030	1SDA066396R1	9,410	
	220-240Vac-220-250V DC F/P	1SDA066392R1 ■		1SDA066399R1 ■		
	380-440 V AC F/P	1SDA066393R1 ■		1SDA066400R1		
	24-30 VAC/DC W			1SDA066403R1		
	220-240Vac-220-250V DC W			1SDA066406R1		10,190
	380-440 V AC W			1SDA066407R1		
T5-T6	24V AC/DC F/P	1SDA054880R1	11,170	1SDA054887R1	15,100	
	220...240V AC-220...250V DC F/P	1SDA054884R1 ■				
	380...440V AC F/P	1SDA054885R1 ■				
T7-T7M	24V AC/DC	1SDA062087R1	Upon request			
	220...240V AC/DC	1SDA063552R1				
	380...400V AC	1SDA062093R1				

Note: For T7 TM in Withdrawable version sliding contact blocks for fixed and moving parts are necessary.  
F/P: Fixed/Plug-in ; W: Withdrawable

## Electrical signals

Auxiliary contact cabled-version - AUX - C			
Frame	Description	Ordering code	L.P. (₹)
XT1....XT4	AUX-C 1Q+1SY 250V AC/DC XT1...XT4 F/P	1SDA066431R1 ■	2,320
	AUX-C 2Q+1SY 250VAC/DC XT1...XT4 F/P	1SDA066433R1 ■	3,670
	AUX-C 3Q+1SY 250VAC/DC XT2...XT4 F/P	1SDA066434R1 ■	4,350
	AUX-C 3Q+2SY 250VAC/DC XT2-XT4 F/P	1SDA066436R1	5,320
	AUX-C 2Q+2SY+1S51 250VAC/DC XT2-XT4 F/P	1SDA066438R1	5,760
	AUX-C 2Q 400V AC XT2-XT4 F/P	1SDA066440R1	2,770
	AUX-C 1Q+1SY 400Vac XT2-XT4 F/P	1SDA066444R1	4,380
	AUX-C 1Q+1SY 24Vdc XT1...XT4 F/P	1SDA066446R1 ■	3,230
	AUX-C 3Q+1SY 24VDC XT2...XT4 F/P	1SDA066448R1	5,030
	T5-T6	AUX-C 1Q 1SY 250V AC/DC C T4-T5-T6	1SDA054910R1
AUX-C 1Q 1SY 400V AC C T4-T5-T6		1SDA054912R1	4,710
AUX-C 2Q 400V AC C T4-T5-T6		1SDA054913R1	5,410
AUX-C 3Q 1SY 24VDC C T4-T5-T6		1SDA054915R1	5,070
AUX-C 3Q 1SY 250V AC/DC C T4-T5-T6		1SDA054911R1 ■	5,980

Note : Q=Changeover contact;SY= Trip indication contact ;F/P: Fixed/Plug-in ; W: Withdrawable

Auxiliary contact - AUX (Uncabled version)			
Frame	Description	Ordering code	L.P. (₹)
XT1....XT4	AUX 1Q 250Vac/dc XT1...XT4	1SDA066422R1 ■	1,400
	AUX 1Q 24Vdc XT1...XT4	1SDA066423R1	2,140

Auxiliary contact - AUX			
Frame	Description	Ordering code	L.P. (₹)
T5..T6(1)	AUX 1Q 1SY 250V AC/DC T1...T6 (1)	1SDA051368R1 ■	2,450
	AUX 3Q 1SY 250V AC/DC T1...T6 (1)	1SDA051369R1	3,910
	AUX 3Q 1SY 24V DC T1...T6 (1)	1SDA054914R1	3,770
T5	AUX-SA 1 S51 T4-T5	1SDA055050R1	2,450
T7M	AUX 2Q 24V DC T7M-X1	1SDA062101R1	Upon request
	AUX 2Q 400V AC T7M-X1	1SDA062102R1	
T7M	AUX SA T7M-X1 S51 24VDC	1SDA066100R1	Upon request
	AUX SA T7M-X1 S51 250VAC	1SDA063553R1	
T7	AUX 1Q + 1SY 24V DC T7	1SDA062103R1	Upon request
	AUX 1Q + 1SY 400V AC T7	1SDA062104R1 ■	

Note : Q=Changeover contact;SY= Trip indication contact  
For T7 / T7M in Withdrawable version sliding contact blocks for fixed and moving parts are necessary.

Cabled contact in electronic version			
Frame	Description	Ordering code	L.P. (₹)
T5	AUX-E-C 1Q 1SY T4-T5	1SDA054916R1	7,920
T6	AUX-E-C 1Q 1SY T6	1SDA064161R1	9,220

■ Stock items

# Tmax accessories

## Key lock

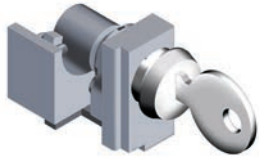

Key Lock - KLC			
Frame	Description	Ordering code	L.P. (₹)
KLC for Manual Breaker			
XT1....XT4	KLC XT1 KEY LOCK RONIS ON CB DIFF.KEY	1SDA066593R1	
	KLC XT1 KEY LOCK RONIS ON CB TYPE A	1SDA066594R1	
	KLC XT1 KEY LOCK RONIS ON CB TYPE B	1SDA066595R1	
	KLC XT1 KEY LOCK RONIS ON CB TYPE C	1SDA066596R1	
	KLC XT1 KEY LOCK RONIS ON CB TYPE D	1SDA066597R1	
	KLC XT1 KEY LOCK RONIS EQ.FEL.A OP/CL	1SDA066598R1	
	KLC XT2-XT4 KEY LOCK RONIS SE.OP.xC.BRE.	1SDA066599R1	
	KLC XT2-XT4 KEY LOCK RONIS ON CB TYPE A	1SDA066600R1 ■	
	KLC XT2-XT4 KEY LOCK RONIS ON CB TYPE B	1SDA066601R1	2,950
	KLC XT2-XT4 KEY LOCK RONIS ON CB TYPE C	1SDA066602R1	
	KLC XT2-XT4 KEY LOCK RONIS ON CB TYPE D	1SDA066603R1	
	KLC XT2-XT4 KEY LOCK RONIS EQ.FE.A OP/CL	1SDA066604R1	
	KLC XT3 KEY LOCK RONIS SEV.OP. X C.BREA.	1SDA066605R1	
	KLC XT3 KEY LOCK RONIS ON CB TYPE A	1SDA066606R1	
	KLC XT3 KEY LOCK RONIS ON CB TYPE B	1SDA066607R1	
	KLC XT3 KEY LOCK RONIS ON CB TYPE C	1SDA066608R1	
KLC XT3 KEY LOCK RONIS ON CB TYPE D	1SDA066609R1		
KLC XT3 KEY LOCK RONIS EQ.FEL.A OP/CL	1SDA066610R1		
T7	KLC-D Key Lock - Different Key in Open Position T7	1SDA062134R1	
	KLC-S Same Key for Different Groups of Circuit Breakers (N. 20005) T7	1SDA062135R1	
	KLC-S Same Key for Different Groups of Circuit Breakers (N. 20006) T7	1SDA062136R1	
	KLC-S Same Key for Different Groups of Circuit Breakers (N. 20007) T7	1SDA062137R1	Upon request
	KLC-S Same Key for Different Groups of Circuit Breakers (N. 20008) T7	1SDA062138R1	
	KLC Arrangement for Ronis Key Lock T7	1SDA062139R1	
T7 M	KLC Arrangement for Profalux Key Lock T7	1SDA062140R1	
	KLC-D Different Key in open Position T7M	1SDA062141R1	
	KLC-S Same Key for Different Groups of Circuit Breakers (N. 20005) T7M	1SDA062142R1	
	KLC-S Same Key for Different Groups of Circuit Breakers (N. 20006) T7M	1SDA062143R1	
	KLC-S Same Key for Different Groups of Circuit Breakers (N. 20007) T7M	1SDA062144R1	Upon request
	KLC-S Same Key for Different Groups of Circuit Breakers (N. 20008) T7M	1SDA062145R1	
	KLC Same Key Ronis-Profalux T7M	1SDA062146R1	



Pad Lock - KLC			
Frame	Description	Ordering code	L.P. (₹)
KLC for Manual breaker			
XT1....XT4	PLL XT1-XT3 REMOV.PADL.DEVICE OPEN PLUG	1SDA066588R1	
	PLL XT1-XT3 PADLOCKS DEVICE OPEN	1SDA066589R1	
	PLL XT2-XT4 PADLOCKS DEVICE OPEN	1SDA066590R1	2,180
	PLL XT1-XT3 PADLOCKS DEVICE OP/CL	1SDA066591R1	
	PLL XT2-XT4 PADLOCKS DEVICE OP/CL	1SDA066592R1	



Key Lock for Rotary Handle - RHL			
Frame	Description	Ordering code	L.P. (₹)
XT1....XT4	RHL XT1..XT4 KEY LOCK RONIS SEVERAL	1SDA066617R1 ■	
	RHL XT1..XT4 KEY LOCK RONIS TYPE A	1SDA066618R1 ■	
	RHL XT1..XT4 KEY LOCK RONIS TYPE B	1SDA066619R1	
	RHL XT1..XT4 KEY LOCK RONIS TYPE C	1SDA066620R1	2,330
	RHL XT1..XT4 KEY LOCK RONIS TYPE D	1SDA066621R1	
	RHL XT1..XT4 KEY LOCK RONIS SEVER. OP/CL	1SDA066622R1	
	RHL XT1..XT4 KEY LOCK RONIS SEVER. OP/CL	1SDA069182R1	
	MOL-D XT1-XT3 KEY LOCK RONIS DIFF. KEY	1SDA066623R1	

■ Stock items



# Tmax accessories

Key Lock for Front/Rotary/Fixed Part- KLF			
Frame	Description	Ordering code	L.P. (₹)
T5	KLF-D Lock for Front/Rotary Handle - Different Key in open Position T4-T5	1SDA054939R1	4,980
	KLF-S Block for Front/Rotary Handle - Same Key (N. 20005) T4-T5	1SDA054940R1 ■	
	KLF-S Block for Front/Rotary Handle - Same Key (N. 20006) T4-T5	1SDA054941R1	
	KLF-S Block for Front/Rotary Handle - Same Key (N. 20007) T4-T5	1SDA054942R1	
	KLF-S Block for Front/Rotary Handle - Same Key (N. 20008) T4-T5	1SDA054943R1	
T5-T6	KLF-D FP Different Key for Each Circuit Breaker T4-T5-T6	1SDA055230R1	4,720
	KLF-D FP Same Key for Different Groups of Circuit Breakers T4-T5-T6	1SDA055231R1	
	KLF-D Ronis Fixed Part- Lock Type Ronis T4-T5-T6	1SDA055233R1	
T6	KLF-D Different Key in open Position T6	1SDA060658R1	5,160
	KLF-S Same Key for Different Groups of Circuit Breakers (N. 20005) T6	1SDA060659R1	
	KLF-S Same Key for Different Groups of Circuit Breakers (N. 20006) T6	1SDA060660R1	
	KLF-S Same Key for Different Groups of Circuit Breakers (N. 20007) T6	1SDA060661R1	
	KLF-S Same Key for Different Groups of Circuit Breakers (N. 20008) T6	1SDA060662R1	
T7	KLF-D Different Key in open Position T7	1SDA063555R1	Upon request
	KLF-S Same Key for Different Groups of Circuit Breakers (N. 20005) T7	1SDA063556R1	
	KLF-S Same Key for Different Groups of Circuit Breakers (N. 20006) T7	1SDA063557R1	
	KLF-S Same Key for Different Groups of Circuit Breakers (N. 20007) T7	1SDA063558R1	
	KLF-S Same Key for Different Groups of Circuit Breakers (N. 20008) T7	1SDA063559R1	
	KLF Arrangement for Ronis key lock T7	1SDA063560R1	
	KLF Arrangement for Profalux key lock T7	1SDA063561R1	

## Key lock for motor operated- MOL

Frame	Description	Ordering code	L.P. (₹)
XT1-XT3	MOL-S XT1-XT3 KEY LOCK RONIS TYPE A	1SDA066624R1	4,990
	MOL-S XT1-XT3 KEY LOCK RONIS TYPE B	1SDA066625R1	
	MOL-S XT1-XT3 KEY LOCK RONIS TYPE C	1SDA066626R1	
	MOL-S XT1-XT3 KEY LOCK RONIS TYPE D	1SDA066627R1	
XT2-XT4	MOL-D XT2-XT4 KEY LOCK RONIS DIFF. KEY	1SDA066629R1	4,990
	MOL-S XT2-XT4 KEY LOCK RONIS TYPE A	1SDA066630R1	
	MOL-S XT2-XT4 KEY LOCK RONIS TYPE B	1SDA066631R1	
	MOL-S XT2-XT4 KEY LOCK RONIS TYPE C	1SDA066632R1	
	MOL-S XT2-XT4 KEY LOCK RONIS TYPE D	1SDA066633R1	
T5	MOL-M XT2-XT4 KEY LOCK RONIS MAN. OPER.	1SDA066634R1	4,990
	MOL-D - Same Key T4-T5	1SDA054904R1	
	MOL-S - Same Key for Different Groups of Circuit Breakers (N. 20005) T4-T5	1SDA054905R1 ■	
	MOL-S - Same Key for Different Groups of Circuit Breakers (N. 20006) T4-T5	1SDA054906R1	
	MOL-S - Same Key for Different Groups of Circuit Breakers (N. 20007) T4-T5	1SDA054907R1	
T5-T6	MOL-S - Same Key for Different Groups of Circuit Breakers (N. 20008) T4-T5	1SDA054908R1	4,990
	MOL-M - Lock only on Manual Operation - Same Key T4-T5-T6	1SDA054909R1	
T6	MOL-D - Different Key T6	1SDA060611R1	4,990
	MOL-S - Same Key for Different Groups of Circuit Breakers (N. 20005) T6	1SDA060612R1	
	MOL-S - Same Key for Different Groups of Circuit Breakers (N. 20006) T6	1SDA060613R1	
	MOL-S - Same Key for Different Groups of Circuit Breakers (N. 20007) T6	1SDA060614R1	
	MOL-S - Same Key for Different Groups of Circuit Breakers (N. 20008) T6	1SDA060615R1	



## Motor operator with direct action - MOD

Frame	Description	Ordering code	L.P. (₹)
XT1-XT3	MOD XT1-XT3 24 V dc	1SDA066457R1	32,080
	MOD XT1-XT3 48...60 V dc	1SDA066458R1	
	MOD XT1-XT3 110...125 V ac/dc	1SDA066459R1	
	MOD XT1-XT3 220...250 V ac/dc	1SDA066460R1 ■	32,080
	MOD XT1-XT3 380...440 V ac	1SDA066461R1	
	MOD XT1-XT3 480...525 V ac	1SDA066462R1	



# Tmax accessories



Stored Energy Motor Operator - MOE, Stored energy motor operator with electronics - MOE-E					
Frame	Description	MOE	L.P. (₹)	MOE-E	L.P. (₹)
XT2-XT4	24 V DC	1SDA066463R1	45,720	1SDA066469R1	
	220...250 V AC / DC	1SDA066466R1 ■	39,390	1SDA066472R1	49,300
	380...440 V AC	1SDA066467R1	45,720	1SDA066473R1	
T5	24 V DC	1SDA054894R1		1SDA054899R1	
	220...250 V AC / DC	1SDA054897R1 ■	47,280	1SDA054902R1 ■	63,800
T6	24 V DC	1SDA060395R1		1SDA060400R1	
	220...250 V AC / DC	1SDA060398R1 ■	58,640	1SDA060403R1	78,520

Low insulating terminal covers - LTC					
Frame	Description	3 Pole-2 pcs	L.P. (₹)	4 Pole-2 pcs	L.P. (₹)
XT1...XT4	LTC XT1	1SDA066655R1		1SDA066656R1	
	LTC XT2	1SDA066657R1	2,830	1SDA066659R1	3,290
	LTC XT3	1SDA066660R1		1SDA066661R1	3,670
	LTC XT4	1SDA066662R1	2,990	1SDA066663R1	4,190
T5	LTC T5	1SDA054968R1	3,970	1SDA054969R1	5,190
T6	LTC T6	1SDA014038R1	4,330	1SDA014039R1	5,740
T7-T7M	LTC T7-T7M	1SDA063093R1	Upon request	1SDA063094R1	Upon request

X3 connector					
Frame	Description	X3 connector PR222DS or PR223DS	L.P. (₹)	X4 connector	L.P. (₹)
T5-T6	For fixed breaker	1SDA055059R1		1SDA055060R1	
	For plug-in/withdrawable breaker	1SDA055061R1	5,410	1SDA055062R1	5,410

High insulating terminal covers - HTC					
Frame	Description	3 Pole-2 pcs	L.P. (₹)	4 Pole-2 pcs	L.P. (₹)
XT1...XT4	HTC XT1	1SDA066664R1	3,860	1SDA066665R1	5,120
	HTC XT2	1SDA066666R1	4,380	1SDA066667R1	5,780
	HTC XT3	1SDA066668R1	4,740	1SDA066669R1	6,330
	HTC XT4	1SDA066670R1	5,280	1SDA066671R1	7,000

Time delay device for under voltage release- UVD				
Frame	Description	Ordering code	L.P. (₹)	
XT1...XT4	UVD T1...T6 - XT1...XT4 24...30 Vac/dc	1SDA051357R1	50,700	
T5...T6	UVD T1...T6 - XT1...XT4 220...250 Vac/dc	1SDA051361R1		
T7-T7M	UVD 24/30V AC/DC E1/6 - T7-T7M-X1	1SDA038316R1	Upon request	
	UVD 220...250V AC/DC E1/6 - T7-T7M-X1	1SDA038320R1		

■ Stock items

# Tmax accessories



Residual current devices			
Frame	Description	Ordering code	L.P. (₹)
XT1	RC Inst x XT1 3p F	1SDA067122R1	29,460
	RC Sel x XT1 3p F	1SDA067123R1	
	RC Sel x XT1 4p F	1SDA067121R1	42,500
XT2	RC Inst x XT1 4p F	1SDA067124R1	34,090
	RC Sel x XT1 4p F	1SDA067125R1	
	RC Sel x XT2 4p F	1SDA067126R1	62,320
XT3	RC Inst x XT3 3p F	1SDA067127R1	73,030
	RC Sel x XT3 3p F	1SDA067128R1	81,130
	RC Inst x XT3 4p F	1SDA067129R1	78,540
	RC B Type x XT3 4p F	1SDA067132R1	1,21,970
T5	RC Sel x XT3 4p F	1SDA067130R1	86,430
	RC222/5 4p Fixed T5	1SDA054955R1	89,070



Bracket for fixing onto DIN rail			
Frame	Description	Ordering code	L.P. (₹)
XT1	KIT DIN50022 XT1 3p PLATE DIN	1SDA066652R1	2,340
	KIT DIN50022 XT1 4p PLATE DIN	1SDA066419R1	2,490
	KIT DIN50022 XT1+RC Sel 200 PLATE DIN	1SDA067134R1	2,740
	KIT DIN50022 XT1+RC PLATE DIN	1SDA067135R1	2,960
XT3	KIT DIN50022 XT3 3p PLATE DIN	1SDA066420R1	
	KIT DIN50022 XT3 4p PLATE DIN	1SDA066421R1	3,250
XT2	KIT DIN50022 XT3+RC PLATE DIN	1SDA067139R1	
	KIT DIN50022 XT2-XT4 PLATE DIN	1SDA066653R1	2,340



## Automation transfer switch - ATS

Automatic transfer switch			
Frame	Description	Ordering code	L.P. (₹)
XT2-XT4/ T5-T7/ E1-E6	ATS021	1SDA065523R1	1,22,630
	ATS022	1SDA065524R1	1,34,560

Note : ATS will be used along with either two motorized ACB or MCCBs with required interlocking and changeover base plate as per the requirement.



Spring charging motor- M			
Frame	Description	Ordering code	L.P. (₹)
T7M	M 24...30V AC/DC T7M	1SDA062113R1	Upon request
	M 220...250V AC/DC T7M	1SDA062116R1	
	M 380...415V AC T7M	1SDA062117R1	



Frame	Description	Ordering code	L.P. (₹)
T7M	SCR 24V AC/DC T7M-X1	1SDA062076R1	Upon request
	SCR 220...240V AC/DC T7M-X1	1SDA063550R1	
	SCR 415...440V AC T7M-X1	1SDA062083R1	

# Tmax accessories



Mechanical interlock between circuit breakers			
Frame	Description	Ordering code	L.P. (₹)
XT1....XT4	MIR-HR XT1..XT4 MECH INTERLOCK HOR. 2 CB**	1SDA066637R1	17,850
	MIR-VR XT1..XT4 MECH INTERLOCK VER. 2 CB**	1SDA066638R1	
	MIR-P PLATE x XT1 F	1SDA066639R1	6,250
	MIR-P PLATE x XT2 F	1SDA066641R1	
	MIR-P PLATE x XT3 F	1SDA066643R1	
	MIR-P PLATE x XT4 F	1SDA066645R1	

Note : \*\* Following must be ordered to make the rear interlock.

1. A MIR-HR or MIR-VR
2. A plate MIR-P for each circuit breaker to be interlocked



Mechanical interlock between circuit breakers - MIR - to be used with copper spreaders only			
Frame	Description	Ordering code	L.P. (₹)
T5	MIR-HB Horizontal Interlock Frame Unit T4-T5	1SDA054946R1	13,540
	MIR-VB Vertical Interlock Frame Unit T4-T5	1SDA054947R1	
	MIR-P Plate for Interlock Type D T5 400 (F-P-W) or T5 630 (F)+T5 400 (F-P-W) or T5 630 (F)	1SDA054951R1	13,540
	MIR-P Plate for Interlock Type E T5 400 (F-P-W) or T5 630 (F) + T5 630 (P-W)	1SDA054952R1	6,990
	MIR-P Plate for Interlock Type F T5 630 (P-W) + T5 630 (P-W)	1SDA054953R1	6,590
T6	MIR-H Horizontal Mechanical Interlock T6	1SDA060685R1	21,210
	MIR-V Vertical Mechanical Interlock T6	1SDA060686R1	

Note: For interlocking in T4-T5, Order both frame and plate unit



Mechanical interlock with cables between 2 circuit breakers			
Frame	Description	Ordering code	L.P. (₹)
T7-T7M	Cable Kit for InterlockT7-T7M	1SDA062127R1	Upon request
	Cable Kit for InterlockT7-T7M with E1-6	1SDA064568R1	
	Plate for Interlock T7-T7M Fixed	1SDA062129R1	
	Plate for Interlock T7-T7M withdrawble	1SDA062131R1	

Note: It is necessary to order 2 plates and one kit of cables

Accessories for electronic trip units			
Frame	Description	Ordering code	L.P. (₹)
XT2-XT4	EKIP COM x LSI-LSIG-M/LRIU XT2-XT4 F/P	1SDA068661R1	23,530
	EKIP COM x LSI-LSIG-M/LRIU XT2-XT4 W	1SDA068662R1	
	KIT x CONNECTION Vaux 24Vdc XT2-XT4 F/P	1SDA066980R1	5,090
	KIT x CONNECTION Vaux 24Vdc XT2-XT4 W	1SDA066981R1	5,720

Note:- F/P: Fixed/Plug-in ; W:Withdrawable

Test and configuration unit			
Frame	Description	Ordering code	L.P. (₹)
XT2 - XT4	Ekip TT Trip test unit	1SDA066988R1	8,040



IP54 Protection for transmitted rotary handle			
Frame	Description	Ordering code	L.P. (₹)
XT1....XT4	IP54 Protection for transmitted rotary handle-RHE	1SDA066587R1	3,030

# Tmax conversion kit

## Plug-in Kit



Fixed part of a plug-in circuit-breaker

+



Fixed circuit-breaker

+



Moving part of a plug-in circuit-breaker

=



Plug-in circuit-breaker

## Drawout Kit



Fixed part of a withdrawable circuit-breaker

+



Fixed circuit-breaker

+



Moving part of a withdrawable circuit-breaker

+



Frontal accessory FLD\*

=



Withdrawable circuit-breaker

## Plug-in and drawout conversion

Frame	Description	3 Pole	L.P. (₹)	4 Pole	L.P. (₹)
XT1	Plug-in moving part	1SDA066276R1	6,210	1SDA066277R1	8,260
	Plug-in fixed part	1SDA068183R1	11,390	1SDA068185R1	15,560
XT2	Plug-in moving part	1SDA066278R1	6,920	1SDA066279R1	9,020
	Plug-in fixed part	1SDA068187R1	12,460	1SDA068190R1	17,000
XT3	Plug-in moving part	1SDA066280R1	8,580	1SDA066281R1	10,150
	Plug-in fixed part	1SDA068192R1	12,820	1SDA068194R1	17,880
XT4	Plug-in moving part	1SDA066282R1	10,060	1SDA066283R1	13,170
	Plug-in fixed part	1SDA068196R1	13,860	1SDA068198R1	18,460
T5	Plug-in moving part	1SDA054843R1	12,710	1SDA054844R1	17,140
	Plug-in fixed part	1SDA054749R1	22,900	1SDA054752R1	27,350
	Plug-in moving part	1SDA054847R1	14,610	1SDA054848R1	20,060
	Plug-in fixed part	1SDA054762R1	25,840	1SDA054765R1	31,740
XT2	Drawout moving part	1SDA066284R1	11,440	1SDA066285R1	15,560
	Drawout fixed part	1SDA068200R1	25,540	1SDA068202R1	33,840
XT4	Drawout moving part	1SDA066286R1	13,030	1SDA066287R1	17,000
	Drawout fixed part	1SDA068204R1	26,810	1SDA068206R1	35,770
T5	Drawout moving part	1SDA054845R1	19,460	1SDA054846R1	27,350
	Drawout fixed part	1SDA054755R1	40,530	1SDA054758R1	50,680
	Drawout moving part	1SDA054849R1	25,020	1SDA054850R1	30,280
	Drawout fixed part	1SDA054768R1	42,010	1SDA054771R1	62,350
T6	Drawout moving part	1SDA060390R1	28,500	1SDA060391R1	34,810
	Drawout fixed part	1SDA060384R1	59,840	1SDA060387R1	77,280
T7	Drawout moving part	1SDA062162R1	Upon request	1SDA062163R1	Upon request
	Drawout fixed part	1SDA062045R1		1SDA062049R1	

### Note:

- 1) For T5 630 -circuit-breaker and switch-disconnector in Plug-in and withdrawable version In max = 570 A
- 2) Front for lever operating mechanism or rotary handle or motor operator
- 3) Sliding contacts blocks if the circuit-breaker is automatic or fitted with electrical accessories (only for T7)
- 4) For T5 630 -circuit-breaker and switch-disconnector in Plug-in and withdrawable version In max = 570 A

\* FLD or rotary handle or motor operator is mandatory to select for a drawout MCCB

# Tmax conversion kit

## Accessories:

Frame / Type	Description	Ordering code	L.P. (₹)	
Connector	Socket-plug panel connector with 3PINS (XT1...XT4)	1SDA066409R1	1,780	
	Socket-plug panel connector with 6PINS (XT1...XT4)	1SDA066410R1	3,450	
	Socket-plug panel connector with 9PINS (XT1...XT4)	1SDA066411R1	5,200	
	Socket-plug panel connector with 15PINS (XT1...XT4)	1SDA066412R1	8,550	
	Socket-plug connector of moving part 12PINS (XT2...XT4)	1SDA066413R1	9,230	
	Socket-plug connector of fixed part 12PINS (XT2...XT4)	1SDA066414R1		
	Connector 4th pole SOR-PS-SOR (XT2...XT4)	1SDA066415R1	1,770	
	Connector 4th pole UVR (XT2...XT4)	1SDA066418R1	1,630	
	ADP 5pin SOR-C /UVR-C T4-T5-T6 P/W	1SDA055173R1	2,990	
	ADP 6pin AUX -C T4-T5-T6 P/W	1SDA054922R1 ■	2,600	
	ADP 10pin MOE AUE -C T4-T5-T6 P/W	1SDA054924R1	3,290	
	ADP 12pin AUX -C T4-T5-T6 P/W	1SDA054923R1	4,200	
	MOT T7M	LEFT SLIDING CONTAC.MP C.BR.T7-T7M-X1	1SDA062164R1	Upon request
		LEFT SLIDING CONTAC.FP C.BR.T7M-X1	1SDA062167R1	
SOR/SCR/UVR/AUX - T7-T7M	RIGHT SLIDING CONTAC.MP C.BR.T7-T7M-X1	1SDA062166R1		
	RIGHT SLIDING CONTAC.FP C.BR.T7M-X1	1SDA062169R1		
Central Block for T7-T7M	Central block - MP T7 - T7M	1SDA062165R1		
	Central block - FP T7 - T7M	1SDA062168R1		

# Tmax PV: Photovoltaic range molded case switch disconnecter



Tmax PV is the latest T Generation product up to 1600 A/1100 V DC/1500V DC.

- IEC 60947-3 certification
- 6 different sizes: from the compact T1 (which can be mounted on DIN rail) to high-performance
- T7, available in the two versions, with lever operating mechanism and motor operator
- Rated insulation voltage up to 1150 V DC/1500V DC
- Advantages like
  - excellent performance-dimensions
  - vast and complete range of accessories for all requirements
  - complete remote control with MOE options

Rated current In (A)	Rated voltage	Description	Version / Poles	Ordering code	L.P. (₹)
160	1100 V DC	T1D/PV 160 4p F FC Cu 1100V DC	Fixed / 4p	1SDA069816R1	Upon request
200		T3D/PV 200 4p F FC Cu 1100V DC	Fixed / 4p	1SDA069822R1	
250		T4D/PV 250 4p F F 1100V DC	Fixed / 4p	1SDA069823R1	
500		T5D /PV 500 4p F F 1100V DC	Fixed / 4p	1SDA069824R1	
800		T6D/PV 800 4p F F 1100V DC	Fixed / 4p	1SDA069825R1	
1250		T7D/PV 1250 4p F F 1100V DC	Fixed / 4p	1SDA069826R1	
1250M		T7D/PV 1250 4p F F M 1100V DC	Fixed / 4p	1SDA069827R1	
1600		T7D/PV 1600 4p F F 1100V DC	Fixed / 4p	1SDA069828R1	
1600M		T7D/PV 1600 4p F F M 1100V DC	Fixed / 4p	1SDA069829R1	

Rated current In (A)	Rated voltage	Description	Version / Poles	Ordering code	L.P. (₹)
250	1500V DC	T4D/PV-E 250 4p F F 1500V DC	Fixed / 4p	1SDA073559R1	Upon request
500		T5D/PV-E 500 4p F F 1500V DC	Fixed / 4p	1SDA076898R1	
1250		T7D/PV-E 1250 4p F F M 1500V DC	Fixed / 4p	1SDA073560R1	
1600		T7D/PV-E 1600 4p F F M 1500V DC	Fixed / 4p	1SDA073561R1	
250		KIT 2JUMPER U 2+2PS T4D/PV 250	Kit jumpers	1SDA070454R1	
500		KIT 2JUMPER U 2+2PS T5D/PV-E 500	Kit jumpers	1SDA076899R1	
1250		KIT JUMPER U 2+2PS T7D/PV 1250	Kit jumpers	1SDA070429R1	
1600		KIT JUMPER U 2+2PS T7D/PV 1600	Kit jumpers	1SDA070431R1	

For information contact our nearest sales office

\*Jumper kit is compulsory to order with 1500V DC version

■ Stock items

# Tmax PV: Photovoltaic range MCCB upto 800 V AC

Rated current In (A)	Rated voltage	Description	Version / Poles	Ordering code	L.P. (₹)
80	800 V AC	T4V-HA 250 TMA 80-800 3p F F 800V AC	Fixed / 3p	1SDA083658R1	Upon request
100		T4V-HA 250 TMA 100-1000 3p F F 800V AC	Fixed / 3p	1SDA083659R1	
125		T4V-HA 250 TMA 125-1250 3p F F 800V AC	Fixed / 3p	1SDA083660R1	
160		T4V-HA 250 TMA 160-1600 3p F F 800V AC	Fixed / 3p	1SDA083661R1	
200		T4V-HA 250 TMA 200-2000 3p F F 800V AC	Fixed / 3p	1SDA083662R1	
250		T4V-HA 250 TMA 250-2500 3p F F 800V AC	Fixed / 3p	1SDA083663R1	
320		T5V-HA 400 TMA 320-3200 3p F F 800V AC	Fixed / 3p	1SDA083664R1	
400		T5V-HA 400 TMA 400-4000 3p F F 800V AC	Fixed / 3p	1SDA083665R1	
500		T5V-HA 630 TMA 500-5000 3p F F 800V AC	Fixed / 3p	1SDA083666R1	
630	T5V-HA630 PR221DS-LS/I In630 3p FF800VAC	Fixed / 3p	1SDA083656R1		

Rated current In (A)	Rated voltage	Description	Version / Poles	Ordering code	L.P. (₹)
80	800 V AC	T4V-HA250 TMA80-800 4p FF 800V AC	Fixed / 4p	1SDA083647R1	Upon request
100		T4V-HA250 TMA100-1000 4p FF800V AC	Fixed / 4p	1SDA083648R1	
125		T4V-HA250 TMA125-1250 4pFF 800V AC N100%	Fixed / 4p	1SDA083649R1	
160		T4V-HA250 TMA160-1600 4pFF 800V AC N100%	Fixed / 4p	1SDA083650R1	
200		T4V-HA250 TMA200-2000 4pFF 800V AC N100%	Fixed / 4p	1SDA083651R1	
250		T4V-HA250 TMA250-2500 4pFF 800V AC N100%	Fixed / 4p	1SDA083652R1	
320		T5V-HA400 TMA320-3200 4pFF 800V AC N100%	Fixed / 4p	1SDA083653R1	
400		T5V-HA400 TMA400-4000 4pFF 800V AC N100%	Fixed / 4p	1SDA083654R1	
500		T5V-HA630 TMA500-5000 4pFF 800V AC N100%	Fixed / 4p	1SDA083655R1	
630	T5V-HA630 PR221DS-LS/I In630 4p FF800VAC	Fixed / 4p	1SDA083667R1		

Rated current In (A)	Rated voltage	Description	Version / Poles	Ordering code	L.P. (₹)
250	800 V AC	T4V-HA250 PR222DS-LSIG In250 3p FF800VAC	Fixed / 3p	1SDA107747R1	Upon request
320		T5X-HA400 PR222DS-LSIG In320 3p FF800VAC	Fixed / 3p	1SDA107746R1	
400		T5X-HA400 PR222DS-LSIG In400 3p FF800VAC	Fixed / 3p	1SDA107745R1	

Rated current In (A)	Rated voltage	Description	Version / Poles	Ordering code	L.P. (₹)
250	800 V AC	T4V-HA250 PR222DS-LSIG In250 4p FF800VAC	Fixed / 4p	1SDA113740R1	Upon request
320		T5X-HA400 PR222DS-LSIG In320 4p FF800VAC	Fixed / 4p	1SDA113737R1	
400		T5X-HA400 PR222DS-LSIG In400 4p FF800VAC	Fixed / 4p	1SDA113739R1	

For information contact our nearest sales office

# FORMULA DSA Molded case circuit breaker

## New low voltage molded case circuit breakers up to 630A

### General characteristics

- Conforms to IEC 60947-2
- Fixed thermal magnetic release throughout the range
- Compact dimensions
- Common range of accessories
- Available in 1P, 2P, 3P & 4 pole versions
- Line-load reversibility
- Suitable for DC application till 250Vdc
- Operation voltage till 550VAC, insulation voltage of 690VAC and impulse voltage of 6KV

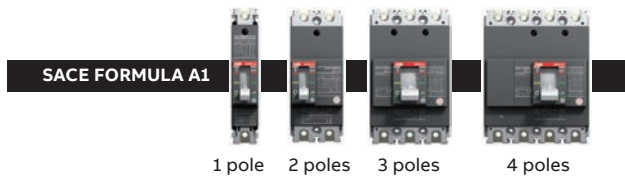

### FORMULA A1

- Rated current, In 15...125A
- 1, 2, 3, 4 pole versions
- Icu = 10, 18, 25, 36KA

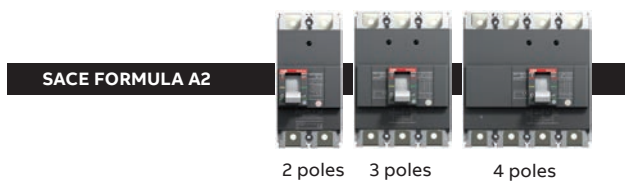

### FORMULA A2

- Rated current, In 125...250A
- 2, 3, 4 pole versions
- Icu = 18, 25, 36KA



### FORMULA A3

- Rated current, In 320...630A
- 3, 4 pole versions
- Icu = 36, 50KA

## FORMULA link system

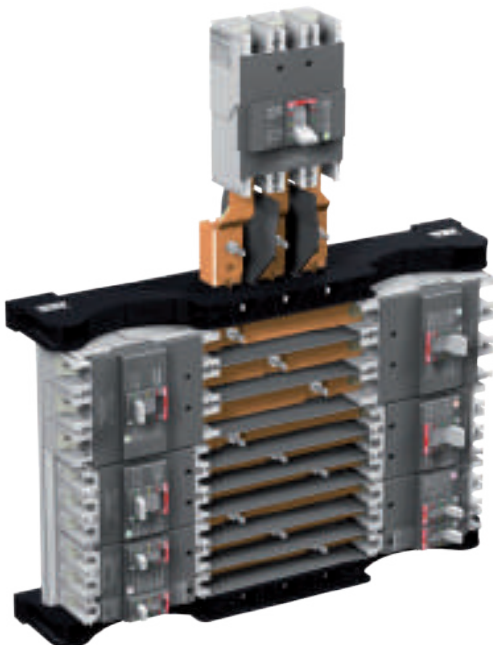

- FORMULA link in accordance with IEC 61439 Standard
- FORMULA link is a component of a power distribution system which divides the main power supply over different users
- The FORMULA link is characterised on the supply side by a main circuit-breaker which protects the whole distribution system, and on the load side by smaller sized circuit-breakers, dedicated to the individual users
- FORMULA link assembly for total discrimination between upstream and downstream devices

### FORMULA link - Electrical characteristics

FORMULA link frame	[A]	250	400	630/800
Incoming breaker		A2	A3	T6
Outgoing breaker		A1	A1-A2	A1-A2
Rated operational voltage 50/60 Hz	[V]	550AC	550AC	550AC
Rated insulation voltage	[V]	690AC	690AC	690AC
Rated short time withstand current (1s)	[KA]	30	40	40



# FORMULA DSA Molded case circuit breaker

Fixed thermal and fixed magnetic MCCB

Breaking capacity at 415VAC

Icu	
A	10kA
B	18kA
C	25kA
N	36kA
S	50kA

TMF / ELT - LI*	A		B		C		N		S		
Frame	In(A)	Ordering code	L.P. (₹)	Ordering code	L.P. (₹)	Ordering code	L.P. (₹)	Ordering code	L.P. (₹)	Ordering code	L.P. (₹)
A1 3 Pole	25	1SDA066512R1 ■		1SDA066699R1		1SDA066711R1		1SDA066723R1			
	32	1SDA068757R1 ■		1SDA068758R1 ■		1SDA068759R1 ■		1SDA068760R1			
	40	1SDA066514R1 ■		1SDA066701R1		1SDA066713R1		1SDA066725R1			
	50	1SDA066515R1 ■	4,630	1SDA066702R1	6,170	1SDA066714R1	7,260	1SDA066726R1	8,820		
	63	1SDA068768R1 ■		1SDA068769R1 ■		1SDA068770R1 ■		1SDA068771R1 ■			
	80	1SDA066518R1 ■		1SDA066705R1		1SDA066717R1 ■		1SDA066729R1			
	100	1SDA066520R1 ■		1SDA066707R1 ■		1SDA066719R1 ■		1SDA066731R1 ■			
A2 3 Pole	125	1SDA066521R1 ■	5,460	1SDA066708R1 ■	7,090	1SDA066720R1 ■	7,930	1SDA066732R1 ■	9,280		
	160			1SDA066549R1 ■	12,210	1SDA066776R1 ■	13,020	1SDA066782R1 ■	13,300		
	200			1SDA066551R1 ■	14,250	1SDA066778R1 ■	15,310	1SDA066784R1 ■	16,770		
	250			1SDA066553R1 ■	15,310	1SDA066780R1 ■	16,360	1SDA066786R1 ■	18,800		
A3 3 Pole	320							1SDA066560R1	37,500	1SDA066562R1	41,080
	400							1SDA066561R1		1SDA066563R1	
	500							1SDA066564R1	45,840	1SDA066565R1	48,620
	630							1SDA066566R1	53,110	1SDA066567R1	54,420

TMF / ELT - LI*	A		B		C		N		S		
Frame	In(A)	Ordering code	L.P. (₹)	Ordering code	L.P. (₹)	Ordering code	L.P. (₹)	Ordering code	L.P. (₹)	Ordering code	L.P. (₹)
A1 3 Pole	25	1SDA066526R1		1SDA066735R1		1SDA066747R1		1SDA066759R1			
	32	1SDA068761R1 ■		1SDA068762R1		1SDA068763R1 ■		1SDA068764R1			
	40	1SDA066528R1		1SDA066737R1		1SDA066749R1		1SDA066761R1			
	50	1SDA066529R1	6,210	1SDA066738R1	8,040	1SDA066750R1	9,630	1SDA066762R1	10,990		
	63	1SDA068772R1 ■		1SDA068773R1 ■		1SDA068774R1 ■		1SDA068775R1 ■			
	80	1SDA066532R1		1SDA066741R1		1SDA066753R1		1SDA066765R1			
	100	1SDA066534R1 ■		1SDA066743R1 ■		1SDA066755R1 ■		1SDA066767R1 ■			
A2 3 Pole	125	1SDA066535R1 ■	6,630	1SDA066744R1 ■	8,510	1SDA066756R1 ■	10,120	1SDA066768R1 ■	11,770		
	160			1SDA066555R1 ■	15,960	1SDA066788R1 ■	16,990	1SDA066794R1 ■	17,370		
	200			1SDA066557R1 ■	18,230	1SDA066790R1 ■	19,670	1SDA066796R1 ■	21,710		
	250			1SDA066559R1 ■	19,870	1SDA066792R1 ■	22,540	1SDA066798R1 ■	23,940		
A3 3 Pole	320							1SDA066568R1	47,080	1SDA066570R1	51,970
	400							1SDA066569R1		1SDA066571R1	
	500							1SDA066572R1	58,810	1SDA066573R1	61,790
	630							1SDA066574R1	68,160	1SDA066575R1	71,400

## Accessories

Terminals			
Front extended spread terminal - ES	Poles	Ordering code	L.P. (₹) 6 pieces
A1	3P	1SDA082242R1 ■	750
A2		1SDA082247R1 ■	2,080

Terminals			
Front extended spread terminal - ES	Poles	Ordering code	L.P. (₹) 8 pieces
A1	4	1SDA082243R1 ■	1,020
A2		1SDA082248R1 ■	2,330

	Description	A1-A2	
		Ordering code	L.P. (₹)
Rotary handle	RHD - Operating mechanism direct handle	1SDA066154R1 ■	1,810
	RHE - Operating mechanism transmitted handle	1SDA066158R1 ■	1,700
Shunt opening release – SOR-C Cabled version	SOR-C 220...240 VAC - 220...250 VDC	1SDA066137R1	2,250
	SOR-C 380...440 VAC	1SDA066138R1	2,250
Auxiliary contacts – AUX-C Cabled version	AUX-C 1Q + 1SY 250 VAC/DC	1SDA066149R1	2,260
	AUX-C 1Q 250V AC/DC A1-A2	1SDA066258R1 ■	1,020
Undervoltage release – UVR-C Cabled version	UVR-C 220...240 VAC - 220...250 VDC	1SDA066146R1	3,780
	UVR-C 380...440 VAC	1SDA066147R1	

\*Available in A3

# Switches

ABB has a wide portfolio of low voltage switches. They are suitable for diverse applications, in motor control centers, in switch boards and as main switches in various equipments and machines. From single to 8 poles and combination switches for change-over, automatic transfer, bypass, reversing, etc.

## Switch disconnectors 16 – 4000 A

The switch disconnector is largely used as the main switch in low voltage switchgears for distribution of power, starting and stopping motors and isolating loads during maintenance.

The range from 16 to 125 Amps are either base plate or door mounted by snap-on or screw fitting front operated 3, 4, 6 and 8-pole are available as standard.

From 160 to 4000 Amps the switch disconnectors, also called load break switches, are designed as pole modules and they are available as 1, 2, 3 and 4-pole versions, front or side operated.

## Switch disconnectors OTDC and OTDCP 10 – 1000 A

The OTDC range of switch-disconnectors is specially designed for DC applications. Thanks to a compact design, efficiency and reliability, OTDC switches bring photovoltaic installations to the next level.

## Switch disconnector fuses 16 – 1250 A

The switch disconnector fuse is used as the main switch in low voltage switchgears in industry for distributing power and protecting motors, cables and other devices against short circuits and over loads.

The switch disconnector fuses are available for all types of fuse links, DIN, BS, NFC, UL, CSA.

The range includes single pole to four pole versions, front-or side-operated. The pole module design enables location of the operating mechanism in any position together with the direction of the terminals giving flexibility to installation in different types of cubicle designs.

## Change-over and transfer switches 16 – 3200 A

ABB's change-over and transfer switches are designed to transfer loads from one power source to another in a wide variety of applications.

The range includes switches from 16 to 3200 Amperes, which can be operated manually, remotely by using a motor or automatically.

ABB's change-over and transfer switches are tested according to IEC 60947-6-1 and IEC 60947-3 standards. The switches have ratings in AC31 and AC33 utilization categories, up to 415 V. In motorized switches, the motor operators have a wide voltage operation range.

## Enclosed switches 16 – 1600 A

The ABB enclosed switches are suitable for power distribution in factories and buildings, as local motor isolators and as main switches. Each incoming supply shall be provided with a hand operated main switch-disconnector according to the Machine Directive EN 60204 and isolate reliably the electrical equipment from the supply.

ABB enclosed switches are designed and tested to meet these requirements and complies with IEC 60 947-3.

The enclosed switches are easy to install and safe to use in industrial, public and residential environments. The indication of the handle is always reliable and lockable in the OFF-position with a standard padlock. ABB's long experience in switch disconnects guarantees a long and safe use.

## Auto Transfer Switches 40 – 3000 A

Technologies for external environment Complete range 40-3000 A. ABB offers a wide selection of automatic transfer switches (ATS). They have the features and functionality that make them suitable for diverse applications.



# DC switch disconnectors for PV application



## OTDC 10A....1000A

- ABB offers a compact DC switch range for single and multi circuit disconnecting
- Carefully designed arc plates and dual magnetic breaking, breaking power is optimized across the entire current range
- As a result of symmetric pole design, the connections are independent of polarity. The user can make the connections in both ways
- OTDC is the only DC switch in the market that has visible contacts
- The mechanism can be located between the poles or on the side of the switch
- Special four pole versions can be made for double circuit applications
- The operation of the switch is not vulnerable to voltage peaks and it is independent of the user (quick make quick break)
- The switches are available in direct mounting handle version as well as external door mounted handle version
- The power losses are very low, results in high efficiency

Rated current In (A)	Rated voltage	Description	Ordering code	L.P. (₹)	Rated voltage	Description	Ordering code	L.P. (₹)
10	1000 V DC	OTDC16F2	1SCA121454R1001	Upon request	1500 V DC			
16		OTDC16F3	1SCA121457R1001					
25		OTDC25F3	1SCA121458R1001 ■					
32		OTDC32F3	1SCA121459R1001 ■					
100 - 200		OTDC200E11K - I	1SCA145988R1001					
250		OTDC250E11K - I	1SCA145994R1001					
315		OTDC315F11K	1SCA158258R1001					
400		OTDC400F11K	1SCA158266R1001					
500		OTDC500F11K	1SCA158274R1001					
630		OTDC630F11K	1SCA158282R1001					
800	OTDC800F11K	1SCA158854R1001						
1000	OTDC1000F22 *	1SCA161286R1001						
						OTDC315FV11K	1SCA158260R1001	
						OTDC400FV11K	1SCA158268R1001	
						OTDC500FV11K	1SCA158276R1001	
						OTDC630FV11K	1SCA158284R1001	Upon request
						OTDC800FV11K	1SCA158857R1001	
						OTDC1000FV22 *	1SCA161288R1001	

Note: The above are direct mounted handle version, we also offer door mounted handle as suffix P version of same ratings.  
\* Handle need to be consider extra

## ONE20

### ONE20

Switches can be used as main switches or for local isolation in various applications, such as HVAC, residential water pumps and heat pumps or commercial lighting.

### Features

- Available in 2-, 3- and 4-pole versions
- Thermal current (Ith) 20A
- Color options: light grey, dark grey, red-yellow
- Weather proof enclosure due to high IP class (IP67) and
- UV resistant material



Poles	Description	Ordering code	L.P. (₹)
2	ONE20M2W	1SCA138456R1001	1,320
3	ONE20M3W	1SCA138457R1001	1,960
4	ONE20M4W	1SCA138459R1001	2,290
2	ONE20M2G	1SCA135532R1001	1,330
3	ONE20M3G	1SCA135535R1001	1,960
4	ONE20M4G	1SCA135538R1001	2,290
2	ONE20M2Y	1SCA135533R1001	1,330
3	ONE20M3Y	1SCA135536R1001	1,960
4	ONE20M4Y	1SCA135540R1001	2,290

# Fusegear

## Easyline - XLP

Fuse Switch Disconnecter 1, 2, 3 & 4P for both AC and DC application 160...630A

EasyLine range got a sturdy, uniform design that is operator friendly and safe with IP 30 from front in closed position and IP 20 in open position.

### Features

- All the XLP cable terminals can be delivered with integrated bolts for cable lugs or with integrated bridge clamps (BC) for easy direct cable connection
- Type tested according to EN60947-3
- Easy to recycle/EN14001 standards
- Quick-make operation device
- Integrated IP20 cable termination
- IP30 degree of protection from the front
- Replacement compatible to similar types in the market
- Voltage measuring from the front
- V-0 plastic materials



EasyLine Fuse Switch Disconnecters are developed and type tested according to IEC60947-3.

### Applications

- UPS: Uninterruptible Power Supply, used for the power supply for computer/servers, storage devices, communication network systems, industry control systems, etc.
- Telecom power supplies
- General protection in smaller distribution panels using 1-pole or 2-pole configurations AC or DC

### Fusegear - Fuse switch disconnecter

Description	Poles	Fuse size	Ordering code	L.P. (₹)
XLP000-6CC		000	1SEP201428R0001	5,020
XLP00-6BC		00	1SEP101890R0002	6,450
XLP1-6BC	3P	1	1SEP101891R0002	16,460
XLP2-6BC		2	1SEP101892R0002	25,750
XLP3-6BC		3	1SEP101975R0002	42,200

## InLine II - ZLBM/ZHBM

Robust and reliable switching and protection

Latest technology of Fuse Switch Disconnecters to ensure the best stability and highest safety in the power distribution network. The new generation InLine II also offers the highest level of personal safety during operation and service.



### Features

- Available as 160A, 250A, 400A, 630A, 800 and 1250A types in combination with NH/DIN HRC Fuse Links acc. to EN/IEC 60269
- Type tested in accordance to EN/IEC 60947-3
- 1 - pole and 3 - pole variants
- For vertical and horizontal installations
- Designed for 185 mm busbar distance
- IP30 degree of protection from the front
  - Padlocking in open and closed position at the 3 - pole version
  - Padlocking in closed position at the 1 - pole version
- Park position with possible padlocking at the 1 - pole type
- Compatible dimensions to equivalent products in the market

### Applications

- Cable Distribution Cabinets (CDC)
- Low voltage distribution in compact secondary substations (CSS)
- Distribution boards for industry, housing and office buildings

# Vertical Fuse Switch Disconnectors

## InLine II - ZLBM/ZHBM



### ZLBM - 1-pole, Depth 121 mm

Type	Ie [A]	Description	Order code	L.P. (₹)	
<b>Basic versions</b>					
ZLBM00-1P-M8	160	3 x M8 Bolts	1SEP620010R1000	Upon request	
ZLBM00-1P-V	160	3 x V-Clamps	1SEP620010R1020		
ZLBM1-1P-M12	250	3 x M12 Universal Bolts	1SEP620011R1000		
ZLBM1-1P-V	250	3 x V-Clamps	1SEP620011R1020		
ZLBM2-1P-M12	400	3 x M12 Universal Bolts	1SEP620012R1000		
ZLBM2-1P-V	400	3 x V-Clamps	1SEP620012R1020		
ZLBM3-1P-M12	630	3 x M12 Universal Bolts	1SEP620013R1000		
ZLBM3-1P-V	630	3 x V-Clamps	1SEP620013R1020		
ZLBM800A-1P-M12	800	12 x M12 Universal Bolts	1SEP620014R1000		
ZLBM910A-1P-M12	910	2 x 3 M12 bolts	1SEP620053R1000		
ZLBM910A-1P-M12-MB	910	2 x 3 M12 bolts, connection on rear side	1SEP620053R1050		
<b>Long terminal cover, 3U shaped busbar versions</b>					
ZLBM00-1P-3U-M8	160	3 x M8 Bolts	1SEP620170R1200		
ZLBM1-L-1P-3U-M12	250	3 x M12 Universal Bolts	1SEP620171R1200		
ZLBM2-L-1P-3U-M12	400	3 x M12 Universal Bolts	1SEP620172R1200		
ZLBM3-L-1P-3U-M12	630	3 x M12 Universal Bolts	1SEP620173R1200		



### ZLBM - 3-pole, Depth 121 mm

Type	Ie [A]	Description	Order code	L.P. (₹)	
<b>ZLBM00 3-pole, 100 mm busbar distance. Cable shroud included.</b>					
ZLBM00-100-3P-M8	160	3 x M8 Bolt	1SEP620150R3000	Upon request	
<b>Basic versions</b>					
ZLBM00-3P-M8	160	3 x M8 Bolts	1SEP620010R3000		
ZLBM00-3P-V	160	3 x V-Clamps	1SEP620010R3020		
ZLBM1-3P-M12	250	3 x M12 Universal Bolt	1SEP620011R3000		
ZLBM1-3P-V	250	3 x V-Clamps	1SEP620011R3020		
ZLBM2-3P-M12	400	3 x M12 Universal Bolt	1SEP620012R3000		
ZLBM2-3P-V	400	3 x V-Clamps	1SEP620012R3020		
ZLBM3-3P-M12	630	3 x M12 Universal Bolt	1SEP620013R3000		
ZLBM3-3P-V	630	3 x V-Clamps	1SEP620013R3020		
ZLBM800A-3P-M12	800	12 x M12 Universal Bolts	1SEP620014R3000		
ZLBM800A-3P-V	800	12 x V-Clamps	1SEP620014R3020		
ZLBM910A-3P-M12	910	2 x 3 M12 bolts	1SEP620053R3000		
ZLBM910A-3P-M12-MB	910	2 x 3 M12 bolts, connection on rear side	1SEP620053R3050		
ZLBM1250A-3P-M12	1250	12 x M12 Universal Bolt	1SEP620015R3000		
ZLBM1250A-3P-V	1250	12 x V-Clamps	1SEP620015R3020		
<b>Without V-Clamps</b>					
ZLBM00-3P-NOV	160	Without V-Clamps	1SEP620010R3010		
ZLBM1-3P-NOV	250	Without V-Clamps	1SEP620011R3010		
ZLBM2-3P-NOV	400	Without V-Clamps	1SEP620012R3010		
ZLBM3-3P-NOV	630	Without V-Clamps	1SEP620013R3010		
<b>Long terminal cover, 3U shaped busbar versions</b>					
ZLBM00-3P-3U-M8	160	3 x M8 Bolts	1SEP620170R3200		
ZLBM1-L-3P-3U-M12	250	3 x M12 Universal Bolts	1SEP620171R3200		
ZLBM2-L-3P-3U-M12	400	3 x M12 Universal Bolts	1SEP620172R3200		
ZLBM3-L-3P-3U-M12	630	3 x M12 Universal Bolts	1SEP620173R3200		

# OFAF HRC fuse links and base, DIN-type

## DIN -type fuse links, gG, 500 V, 80 kA

The ordering code includes one fuse link, the delivery batch is according to the column.

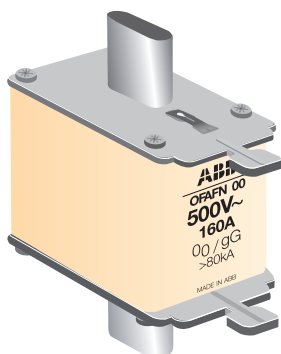

Fuse size	Rated current In (A)	Description	Delivery batch [pcs]	Ordering code	L.P. (₹)
000	2	OFAFN000GG2	6	1SCA107747R1001 ■	290
	6	OFAFN000GG6	6	1SCA107748R1001 ■	
	10	OFAFN000GG10	6	1SCA107749R1001 ■	
	16	OFAFN000GG16	6	1SCA107750R1001 ■	
	20	OFAFN000GG20	6	1SCA107751R1001 ■	
	25	OFAFN000GG25	6	1SCA107751R1002 ■	
	32	OFAFN000GG32	6	1SCA107752R1001 ■	
00	63	OFAFN000GG63	6	1SCA107753R1001 ■	650
	6	OFAFN00GG6	6	1SCA107754R1001	
	10	OFAFN00GG10	6	1SCA107755R1001	
	16	OFAFN00GG16	6	1SCA107756R1001	
	20	OFAFN00GG20	6	1SCA107757R1001	
	25	OFAFN00GG25	6	1SCA107758R1001	
	32	OFAFN00GG32	6	1SCA107759R1001 ■	
	50	OFAFN00GG50	6	1SCA107760R1001 ■	
	63	OFAFN00GG63	6	1SCA107761R1001 ■	
	80	OFAFN00GG80	6	1SCA107762R1001 ■	
	100	OFAFN00GG100	6	1SCA107763R1001 ■	
0	125	OFAFN00GG125	6	1SCA107764R1001 ■	1,250
	160	OFAFN00GG160	6	1SCA107765R1001 ■	
1	160	OFAF0H160	3	1SCA022627R3170	930
	200	OFAF0H200	3	1SCA022629R5140 ■	
	32	OFAFN1GG32	6	1SCA107766R1001	
	50	OFAFN1GG50	6	1SCA107767R1001	
	63	OFAFN1GG63	6	1SCA107768R1001	
	80	OFAFN1GG80	6	1SCA107769R1001	
	100	OFAFN1GG100	6	1SCA107770R1001	
	125	OFAFN1GG125	6	1SCA107771R1001	
	160	OFAFN1GG160	6	1SCA107772R1001 ■	
	200	OFAFN1GG200	3	1SCA107773R1001 ■	
2	250	OFAFN1GG250	3	1SCA107774R1001 ■	1,360
	100	OFAFN2GG100	3	1SCA107775R1001	
	125	OFAFN2GG125	3	1SCA107776R1001	
	250	OFAFN2GG250	3	1SCA107778R1001	
3	315	OFAFN2GG315	3	1SCA107779R1001 ■	2,100
	400	OFAFN2GG400	3	1SCA107780R1001 ■	
	315	OFAFN3GG315	3	1SCA107781R1001	
	500	OFAFN3GG500	3	1SCA107783R1001 ■	
4	630	OFAFN3GG630	3	1SCA107784R1001 ■	2,100
	800	OFAFN3GG800	3	1SCA107785R1001 ■	
4	1250	OFAF4H1250	1	1SCA022627R7830	Upon request
4a	1250	OFAF4AH1250	1	1SCA022637R4360	



Fuse size	Rated current In (A)	Description	Ordering code	L.P. (₹)
00	160		1SCA833001R2001 ■	530
1	250	Fuse Base - Din type	1SCA833001R2002 ■	1,080
2	400		1SCA833001R2003 ■	1,830
3	630		1SCA833001R2004 ■	2,430

■ Stock items

# OFF HRC fuse links and base, BS-type

## BS -type fuse links, gG, 415 V, 80 kA

The type code includes one fuse link, but the delivery batch is according to the column.



Fuse size	Rated current In [A]	Description	Delivery batch [pcs]	Ordering code	L.P. (₹)
<b>Offset blade tag fuse link</b>					
F1	2	OFFNF1GG2	10	1SCA107786R1001 ■	110
	4	OFFNF1GG4	10	1SCA107787R1001 ■	
	6	OFFNF1GG6	10	1SCA107788R1001 ■	
	10	OFFNF1GG10	10	1SCA107789R1001 ■	
	16	OFFNF1GG16	10	1SCA107790R1001 ■	
	20	OFFNF1GG20	10	1SCA107791R1001 ■	
	25	OFFNF1GG25	10	1SCA107792R1001 ■	
	32	OFFNF1GG32	10	1SCA107793R1001 ■	
<b>Offset bolted tag fuse link</b>					
A2	6	OFFNA2GG6	10	1SCA107795R1001	140
	10	OFFNA2GG10	10	1SCA107796R1001	
	16	OFFNA2GG16	10	1SCA107798R1001	
	20	OFFNA2GG20	10	1SCA107827R1001	
	25	OFFNA2GG25	10	1SCA107800R1001	
	32	OFFNA2GG32	10	1SCA107801R1001 ■	
A3	40	OFFNA3GG40	10	1SCA107803R1001 ■	170
	50	OFFNA3GG50	10	1SCA107804R1001	
	63	OFFNA3GG63	10	1SCA107805R1001 ■	
A4	50	OFFNA4GG50	10	1SCA107806R1001	350
	63	OFFNA4GG63	10	1SCA107807R1001	
	80	OFFNA4GG80	10	1SCA107808R1001	
	100	OFFNA4GG100	10	1SCA107809R1001 ■	
	125	OFFNA4GG125	10	1SCA107810R1001 ■	
<b>Central bolted tag fuse link</b>					
B1	50	OFFNB1GG50	10	1SCA107811R1001	430
	63	OFFNB1GG63	10	1SCA107812R1001	
	80	OFFNB1GG80	10	1SCA107813R1001	
	100	OFFNB1GG100	10	1SCA107814R1001	
B2	125	OFFNB2GG125	10	1SCA107816R1001	640
	160	OFFNB2GG160	5	1SCA107817R1001 ■	
	200	OFFNB2GG200	5	1SCA107818R1001 ■	
B3	250	OFFNB3GG250	1	1SCA107819R1001 ■	900
	315	OFFNB3GG315	1	1SCA107820R1001	970
B4	400	OFFNB4GG400	1	1SCA107822R1001	1,570
C1	400	OFFNC1GG400	1	1SCA107823R1001	2,380
C2	500	OFFNC2GG500	1	1SCA107824R1001	2,700
C2	630	OFFNC2GG630	1	1SCA107825R1001	
C3	800	OFFNC3GG800	1	1SCA107826R1001	



Fuse size	Rated current In [A]	Description	Delivery batch [pcs]	Ordering code	L.P. (₹)
F1	20	Control Fuse	100	1SYN833001R2005 ■	190
	32	Base	100	1SYN833001R2009 ■	240

# OESA/OS switch disconnecter fuse, DIN-type

## DIN type

32 - 800A SDF supplied with shaft and handle, Mechanism at the end of the switch fuse

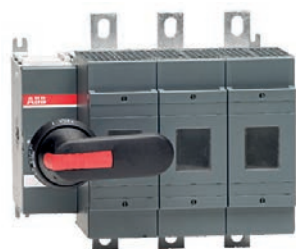
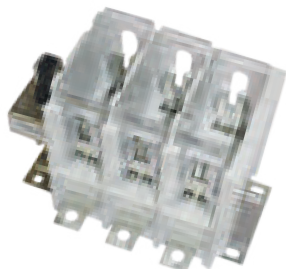

Rated current In [A]	Poles	Recommend Fuse size	Description	Ordering code	L.P. (₹)
32	2	000/ 00	OESA0032D2	1SYN790290P0492	2,790
63			OESA0063D2	1SYN790290P0496	3,730
100		00	OESA00100D2	1SYN790290P0508	6,580
125			OESA125D2	1SYN790290P0511	8,790
160		0	OESA00160D2	1SYN790290P0503	10,000
200			OS200D02P	1SCA022759R9220	12,870
250		0-1	OS250D02P	1SCA022760R0170	15,610
315		0-2	OS315D02P	1SYN833040R2012	19,240
400			OS400D02P	1SCA022811R2740	22,030
630		3	OS630D02P	1SCA107745R1001	37,510
800			OS800D02P	1SCA022837R2650	44,180
1250		4	OS1250D02P	1SCA114051R1001	Upon request
32	3	000/ 00	OESA00-32	1SYN790290P0493 ■	3,070
63			OESA 00-63	1SYN790290P0497 ■	4,200
100		00	OESA00100	1SYN790290P0509 ■	7,920
125			OESA 00125	1SYN790290P0500 ■	10,620
160		0	OESA00-160	1SYN790290P0504 ■	11,360
200			OS200D03P	1SYN022709R9500 ■	14,900
250		0-1	OS250D03P	1SYN022719R0090	17,860
315		0-2	OS315D03P	1SYN953046P3001 ■	23,270
400			OS400D03P	1SYN022719R0250 ■	26,660
630		3	OS630D03P	1SYN022825R2830 ■	45,360
800			OS800D03P	1SYN022825R4880 ■	50,100
1250		4	OS1250D03P	1SCA105475R1001	Upon request
32	TPN	000/ 00	OESA0032N ■	1SYN790290P0494	3,220
63			OESA0063N ■	1SYN790290P0498	4,340
100		00	OESA00100N ■	1SYN790290P0499	8,370
125			OESA00125N ■	1SYN790290P0501	11,210
160		0	OESA00160N ■	1SYN790290P0505	12,530
200			OS200D03N3P	1SYN022749R8710 ■	16,130
250		0-1	OS250D03N3P	1SYN022749R9430 ■	18,760
315			0-2	OS315D03N3P	1SYN953047P3001 ■
400		OS400D03N3P		1SYN022753R9320 ■	27,800
630		3	OS630D03N3P	1SYN100858R1001 ■	46,070
800			OS800D03N3P	1SYN100859R1001 ■	51,620
1250		4	OS1250D03N3P	1SCA107932R1001	Upon request
32	4	000/ 00	OESA 00-32A4	1SYN790290P0495	3,470
63			OESA 00-63A4	1SYN790290P0507 ■	4,670
100		00	OESA00100A4	1SYN790290P0510	9,640
125			OESA00125A4	1SYN790290P0502	12,360
160		0	OESA 00-160A4	1SYN790290P0506	13,420
200			OS200D04N2P	1SYN022709R9680	19,290
250		0-1	OS250D04N2P	1SYN022719R2380	22,210
315			0-2	OS315D04N2P	1SYN953048P3001 ■
400		OS400D04N2P		1SYN022719R2460 ■	30,710
630		3	OS630D04N2P	1SYN022825R4290 ■	51,940
800			OS800D04N2P	1SYN022825R5180 ■	59,560
1250		4	OS1250D04N2P	1SCA105248R1001	Upon request

Notes:  
4<sup>th</sup> pole of all SFU's are 100% rated and are in the switched neutral (SN) version.

- Contact our nearest sales office
- For mechanism inbetween poles configuration
  - For motorized switch disconnecter fuse requirement
  - For 4th pole with fuse protection
  - For Switch disconnecter fuse with direct mounting handle



# OESA/OS switch disconnecter fuse, BS-type

## BS

32 - 800A SDF supplied with shaft and handle

### Mechanism at the end of the switch fuse

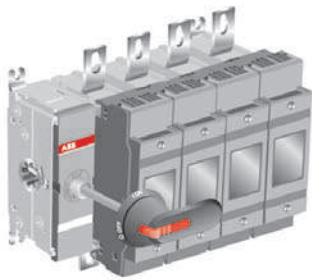
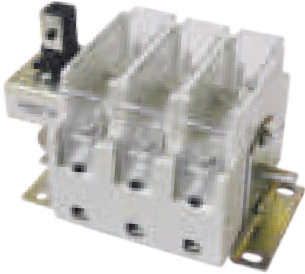

Rated current In [A]	Poles	Recommend Fuse size	Description	Ordering code	L.P. (₹)
32	2	A2	OESA32G2	1SYN790290P0512	2,470
63		A3	OESA63G2	1SYN790290P0516	3,630
100		A4	OESA100G2	1SYN790290P0520	6,430
125			OESA125G2	1SYN790290P0524	8,160
160		B2	OESA160B2	1SYN790290P0528	9,470
200		B1-B2	OS200B02P	1SCA022769R7820	11,440
250		B1-B3	OS250B02P	1SCA022769R9440	14,200
315		B1-B4	OS315B02P	1SCA022817R3450	19,140
400			OS400B02P	1SCA022813R7220	19,840
630		C1-C2	OS630B02P	1SCA113529R1001	34,480
800		C1-C3	OS800B02P	1SCA022837R6480	42,710
1250		D1	OS1250B02P	1SCA114070R1001	Upon request
32	3	A2	OESA32G1	1SYN790290P0513	2,980
63		A3	OESA63G1	1SYN790290P0517 ■	4,050
100		A4	OESA100G1	1SYN790290P0521 ■	7,790
125			OESA125G1	1SYN790290P0525	9,860
160		B2	OESA160B3	1SYN790290P0529	10,750
200		B1-B2	OS200B03P	1SYN022709R9330	13,230
250		B1-B3	OS250B03P	1SYN022750R6660	16,250
315		B1-B4	OS315B03P	1SYN022719R0680	23,120
400			OS400B03P	1SYN022719R0840	24,010
630		C1-C2	OS630B03P	1SYN022825R5850	41,690
800		C1-C3	OS800B03P	1SYN022825R7550	51,620
1250		D1	OS1250B03P	1SCA105250R1001	Upon request
32	TPN	A2	OESA32G1N ■	1SYN790290P0514 ■	3,210
63		A3	OESA63G1N ■	1SYN790290P0518 ■	4,290
100		A4	OESA100G1N ■	1SYN790290P0522 ■	8,530
125			OESA125G1N ■	1SYN790290P0526 ■	10,810
160		B2	OESA160B3N ■	1SYN790290P0530	11,780
200		B1-B2	OS200B03N3P	1SYN022750R0620 ■	16,090
250		B1-B3	OS250B03N3P	1SYN022750R8010 ■	19,070
315		B1-B4	OS315B03N3P	1SYN022753R8940	23,700
400			OS400B03N3P	1SYN022753R9160	26,770
630		C1-C2	OS630B03N3P	1SYN100860R1001	46,420
800		C1-C3	OS800B03N3P	1SYN100861R1001	52,010
1250		D1	OS1250B03N3P	1SCA107936R1001	Upon request
32	4	A2	OESA32G4	1SYN790290P0515	3,530
63		A3	OESA63G4	1SYN790290P0519	4,580
100		A4	OESA100G4	1SYN790290P0523	10,770
125			OESA125G4 ■	1SYN790290P0527	12,360
160		B2	OESA160B4	1SYN790290P0531	13,420
200		B1-B2	OS200B04N2P	1SYN022709R9410	18,750
250		B1-B3	OS250B04N2P	1SYN022750R7800	22,110
315			OS315B04N2P	1SYN022719R2710	28,420
400		B1-B4	OS400B04N2P	1SYN022719R2890	29,270
630		C1-C2	OS630B04N2P	1SYN022825R6230	53,320
800		C1-C3	OS800B04N2P	1SYN022825R8010	59,980
1250		D1	OS1250B04N2P	1SCA105469R1001	Upon request

Note:  
4<sup>th</sup> pole of all SFU's are 100% rated and are in the switched neutral (SN) version.

- Contact our nearest sales office
- For 1250A switch disconnecter fuse requirement
  - For mechanism in between poles configuration
  - For motorized switch disconnecter fuse requirement
  - For 4th pole with fuse protection

■ Stock items

# Accessories for OESA/OS switch disconnecter fuse, 32..800 A



## Phase barriers

Frame	Pole	Height (mm)	Description	Ordering code	L.P. (₹)
OS200...400	3	100	PB100 low	1SDA054970R1 ■	1,470
	4	100	PB100 low	1SDA054971R1 ■	2,100



## Auxiliary contacts

Frame	Contact function	Description	Ordering Code	L.P. (₹)
OESA 32...160	1NO+1NC	OESAZX 15	1SYN790290P0532	670
	2NO+2NC	OESAZX 16	1SYN790290P0533	1,290
OS200...800	1NO	OA1G10	1SCA022353R4970	700
	1NC	OA3G01	1SCA022456R7410	780
Screw mounting to the left side of the switch		OEA28	1SCA022714R8810 ■	920

Note: OEA 28 has to be order along with 200 & 250A TPN switch only



## Fuse monitor

Frame	Rated voltage [Vac]	Description	Ordering code	L.P. (₹)
OS200...800	100...260	OFS260	1SCA022716R0180	9,460
	380...690	OFS690	1SCA022715R9920	9,690



## Wrapped neutral link

Frame	Description	Ordering code	L.P. (₹)
OESA32...63	OESAZX87	1SYN790290P0534	610
OESA100	OESAZX 86/1	1SYN790290P0535	1,080
OESA125...160	OESAZX86	1SYN790290P0536	1,180
OS200...250	OXN250	1SCA022752R9950	5,390
OS315...400	OXN400	1SCA022770R3060	14,080
OS630...800	OXN800S	1SCA022831R4880	16,140

## Handle adaptor

OHB145...OHB175	OHBZX200	1SCA125960R1001	1,680
-----------------	----------	-----------------	-------

## Handles

Frame	Description	Ordering code	L.P. (₹)
OESA32...63	YASDB51	1SYN790290P0537	990
OESA100...160	YASDB10	1SYN790290P0538	1,480
OS200...250	OHB80J6	1SCA022381R0240 ■	2,030
OS315...400	OHB145J12	1SCA022381R2110	2,490
OS630...800	OHB175J12	1SCA022381R2450	2,940

## Shaft

Frame	Description	Ordering code	L.P. (₹)
OESA/OS32...250	OXP6X210	1SCA022295R6080	520
OS315...400	OXP12X250	1SCA022325R6980	1,030
OS630...800	OXP12X280	1SCA022137R5140	1,330

## Fuse covers for OESA switch disconnecter fuse

Frame	Type	Description	Ordering code	L.P. (₹)
32...63	DIN		1SYN833035R2012	110
32...63	BS	Fuse cover	1SYN833036R2012	110
100...160	DIN		1SYN833037R2012	120

Note: Ordering code mentioned above for fuse cover is per piece

■ Stock items

# OT switch disconnectors



## Front operated switch-disconnectors with direct knob type handle

Rated current In [A]	Pole	Description	Ordering code	L.P.(₹)	Pole	Description	Ordering code	L.P.(₹)
16		OT16F3	1SCA104811R1001	1,500		OT16F4N2	1SCA104829R1001	1,870
25		OT25F3	1SCA104857R1001 ■	1,570		OT25F4N2	1SCA104886R1001	1,950
40		OT40F3	1SCA104902R1001	1,780		OT40F4N2	1SCA104932R1001	2,210
63	3	OT63F3	1SCA105332R1001	1,910	4	OT63F4N2	1SCA105365R1001	2,580
80		OT80F3	1SCA105798R1001	3,800		OT80F4N2	1SCA105413R1001	4,750
100		OT100F3	1SCA105004R1001	5,220		OT100F4N2	1SCA105018R1001	6,530
125		OT125F3	1SCA105033R1001	5,340		OT125F4N2	1SCA105051R1001	6,670

## Door mounted switch-disconnectors with snap on and screw type mounting Handle for screw and snap on mouting to be ordered seperately



Rated current In [A]	Pole	Description	Ordering code	L.P.(₹)	Pole	Description	Ordering code	L.P.(₹)
16		OT16FT3	1SCA104838R1001 ■	1,650		OT16FT4N2	1SCA105711R1001	2,060
25		OT25FT3	1SCA104884R1001	2,050		OT25FT4N2	1SCA104900R1001	2,550
40		OT40FT3	1SCA104940R1001 ■	2,460		OT40FT4N2	1SCA104956R1001	3,070
63	3	OT63FT3	1SCA105382R1001	3,390	4	OT63FT4N2	1SCA105393R1001	4,240
80		OT80FT3	1SCA105431R1001	4,170		OT80FT4N2	1SCA105499R1001	5,220
100		OT100FT3	1SCA105023R1001	6,960		OT100FT4N2	1SCA105031R1001	8,690
125		OT125FT3	1SCA105060R1001	8,880		OT125FT4N2	1SCA105066R1001	11,110

# OT switch disconnector accessories 16..125 A

## Accessories for OT 16..125 F / FT

### Screw mounting, hole distance 36 mm

Padlockable with max. 3 padlocks, IP65, hole distance 36/48 mm, NEMA 1, 3R, 12



### Accessories for OT 16..125 F

### Accessories for OT 16..125 FT

Frame	Description	Ordering code	L.P. (₹)	Description	Ordering code	L.P. (₹)
OT16...125F- Black	OHBS2AJ	1SCA105213R1001	780	OHBS2RJ	1SCA105232R1001	910
OT16...125F-Red-yellow	OHYS2AJ	1SCA105296R1001	930	OHYS2RJ	1SCA105323R1001	990

Note:

For any different arrangement kindly contact our nearest sales office.

### Shafts

Suitable for all the switches in this section, OT16...125F

Frame	Description	Ordering code	L.P. (₹)
OT16...125F	OXS6X130	1SCA101655R1001 ■	600

# OT switch disconnectors

## Front operated switch-disconnectors

OT 16A-3200A switch disconnector supplied with extended shaft and IP 65 pistol type handle



Contact our nearest sales office

- For Door mounted switch disconnector
- For different configuration of Shaft and Handle (selector type)
- For 6 & 8 pole switch disconnector requirement
- 1 pole switch disconnector also available on request



Note:

Contact our nearest sales office

- For requirement of motorized isolators
- For mechanism in between poles configuration
- For switch disconnector with direct mounted handle
- For side operated switches

Rated current In [A]	Poles	Description	Ordering code	L.P. (₹)
160	2	OT160EV02P	1SCA120508R1001	8,140
200		OT200E02P	1SCA022751R1400	8,640
250		OT250E02P	1SCA022735R2500	10,660
315		OT315E02P	1SCA022866R5590	12,260
400		OT400E02P	1SCA022741R7210	16,520
630		OT630E02P	1SCA022866R5670	20,710
800		OT800E02P	1SCA022835R4830	25,570
1000		OT1000E02P	1SCA105795R1001	53,220
1250		OT1250E02P	1SCA106136R1001	65,070
1600		OT1600E02P	1SCA106142R1001	88,350
2000		OT2000E02P	1SCA120025R1001	1,10,430
2500		OT2500E02P	1SCA113956R1001	1,38,040
3200	OT3200E02P	1SCA128581R1001	1,98,780	
4000	OT4000E02P	1SCA128595R1001	2,31,910	
16	3	OT16F3	1SYN104811R1001 ■	2,870
25		OT25F3	1SYN104857R1001 ■	2,900
40		OT40F3	1SYN104902R1001 ■	3,020
63		OT63F3	1SYN105332R1001 ■	3,050
80		OT80F3	1SYN105798R1001 ■	4,890
100		OT100F3	1SYN105004R1001 ■	6,510
125		OT125F3	1SYN105033R1001 ■	6,640
160		OT160G03P	1SCA135139R1001	8,420
160		OT160EV03P	1SCA120514R1001 ■	9,010
200		OT200E03P	1SCA022712R0800 ■	9,880
250		OT250E03P	1SCA022710R0100 ■	12,650
315		OT315E03P	1SCA022718R8510 ■	13,630
400	OT400E03P	1SCA022718R8780 ■	18,010	
630	OT630E03P	1SCA022718R8940 ■	22,730	
800	OT800E03P	1SCA022718R9410 ■	28,400	
1000	OT1000E03P	1SCA022860R5930 ■	54,550	
1250	OT1250E03P	1SCA022860R6230 ■	70,950	
1600	OT1600E03P	1SCA022860R6580 ■	96,380	
2000	OT2000E03P	1SCA108036R1001	1,20,260	
2500	OT2500E03P	1SCA104972R1001 ■	1,63,310	
3200	OT3200E03P	1SCA128481R1001	2,24,860	
4000	OT4000E03P	1SCA124848R1001	2,47,580	
16	4	OT16F4N2	1SYN104829R1001	3,090
25		OT25F4N2	1SYN104886R1001	3,220
40		OT40F4N2	1SYN104932R1001 ■	3,280
63		OT63F4N2	1SYN105365R1001	3,740
80		OT80F4N2	1SYN105413R1001 ■	6,420
100		OT100F4N2	1SYN105018R1001 ■	6,910
125		OT125F4N2	1SYN105051R1001 ■	7,120
160		OT160G04P	1SCA135140R1001	11,560
160		OT160EV04P	1SCA120521R1001 ■	12,650
200		OT200E04P	1SCA022713R4930 ■	12,920
250		OT250E04P	1SCA022710R0520 ■	14,740
315		OT315E04P	1SCA022719R1730 ■	15,400
400	OT400E04P	1SCA022719R1810 ■	19,400	
630	OT630E04P	1SCA022719R2030 ■	26,990	
800	OT800E04P	1SCA022719R2110 ■	31,920	
1000	OT1000E04P	1SCA022860R6150	71,960	
1250	OT1250E04P	1SCA022860R6310	90,520	
1600	OT1600E04P	1SCA022860R6740	1,16,050	
2000	OT2000E04P	1SCA108038R1001	1,47,430	
2500	OT2500E04P	1SCA105140R1001	1,87,870	
3200	OT3200E04P	1SCA128482R1001	2,57,150	
4000	OT4000E04P	1SCA124856R1001	2,92,670	

■ Stock items

# OT switch disconnecter accessories



## Handles

Frame	Description	Ordering code	L.P. (₹)
OT16...125	OHB45J6	1SCA022380R8770 ■	1,190
OT160...250	OHB65J6	1SCA022380R9660 ■	1,620
OT315...400	OHB95J12	1SCA022381R0830	1,860
OT630...800	OHB125J12	1SCA022381R1560 ■	2,010
OT1000...4000	OHB274J12	1SCA115920R1001 ■	5,690

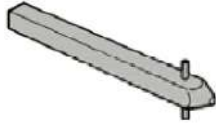

## Shaft

Frame	Description	Ordering code	L.P. (₹)
OT16...125	OSP6X170	1SCA108224R1001 ■	450
OT160...250	OSP6X210	1SCA022295R6080	520
OT315...800	OSP12X185	1SCA022325R6710	820
OT1000...4000	OSP12X280	1SCA022137R5140	1,330



## Auxiliary contact

Frame	Contact function	Description	Ordering code	L.P. (₹)
OT16...4000	1NO	OA1G10	1SCA022353R4970 ■	700
OT16...125	1NC	OA1G01	1SCA022353R4890 ■	700
OT160EV...4000	1NC	OA3G01	1SCA022456R7410 ■	780



## Phase barrier

Frame	Poles	Description	Ordering code	L.P. (₹)
OT160...OT800	3	PB100 low	1SDA054970R1	1,470
OT160...OT800	4	PB100 low	1SDA054971R1	2,100
OT1000...2500	3 & 4	OTB1600/6	1SCA100768R1001	5,120
OT3200...4000	3 & 4	OTB4000/6	1SCA129040R1001	5,120



## Mechanical interlock mechanism

(Prevents one switch from closing to ON-position, if the other is not in OFF-position)

Frame	Shaft distance [mm]	Description	Ordering code	L.P. (₹)
OT16...125	100	OTZW24	1SCA022639R5610	2,600
OT160...250	190	OTZW10	1SCA022431R5280	3,150
OT315...400	250	OETLZW14	1SCA022077R3410	8,020
OT315...800	300	OETLZW3	1SCA022049R0380	8,370
OT315...4000	500	OETLZW15	1SCA022081R9340	9,300



## Terminal shrouds snap-on mounting, transparent

For 3-pole switches

Frame	Description	Ordering code	L.P. (₹)
OT 16...40F3	OTS40T3	1SCA105317R1001	460
OT63...80F3	OTS63T3	1SCA022353R6750 ■	330
OT 100...125F3	OTS125T3	1SCA022379R968	670

Note:

for requirement of terminal shrouds for higher current rating contact our nearest sales office

# Enclosed switches

**Wide range of enclosed heavy duty switches**  
From 16 to 1600 Amperes, 690 V



Enclosed switches are designed and used as main switches for applications, which need to be isolated from the network. The range includes front operated and side operated switch disconnectors, switch fuses and changeover switches enclosed in plastic, steel sheet or stainless steel sheet and aluminium enclosures. They are rated for utilization categories including disconnecting as well as making and breaking the load. In addition, the switch fuses equipped with fuse links protects the application and the cables from overload currents and short circuits.

## **Plastic enclosures**

The plastic enclosures are most suitable for locations with high chemical and moisture requirements. In addition, they are light and easy to install and handle.

## **Steel sheet enclosures**

The steel sheet enclosures are hot dip galvanized and the surface is polyester powder painted. The enclosures are durable and robust for various environments.

## **Stainless steel sheet enclosures**

The stainless steel sheet enclosures are made of AISI 304 stainless steel. They are used particularly in the food and

beverage industry and in locations where high hygiene is required. The smooth surface does not require any painting and is easy to clean.

## **Aluminum alloy enclosures**

Aluminum enclosures have very good impact strength and protection against UV light. They are suitable both for indoor and outdoor use in medium to heavy-duty applications.

## **Safety for personnel – reliable position indication**

- Padlocking in the OFF-position with one, three or six (with the shackle L6) padlocks against unintentional start-up. The handle cannot be padlocked in the OFF-position if one of the contacts is not in the OFF position
- The cover cannot be removed if the handle is padlocked
- Door interlock in the ON-position
- Arc proof, short circuit durability function: Expander washers in aluminium enclosures with  $I_e > 160$  A and door locking release in large metal sheet enclosures type MSC
- Door interlock defeatable with rectangular and pistol type handles

# Zenith Auto Transfer Switch

## Transfer/Bypass-Isolation Transfer Switches



### Electrical ratings:

- Ratings 40 to 3000 amperes
- 2, 3 or 4 Poles
- Open type, NEMA 1, 3R, 4, 4X and 12
- Available to 600 VAC, 50 or 60 Hz
- Suitable for emergency and standby applications on all classes of load, 100% tungsten rated through 400 amps
- UL 1008 listed at 480 VAC
- CSA C22.2 No. 178 certified at 600 VAC
- IEC 947-6-1 listed at 480 VAC



### Proactive outage prevention

- Contact wear monitoring<sup>1</sup> including real-time status and predicted contact end-of-life
- Minimum 3 embedded temperature sensors
- High current protection and alarm
- 24/7 monitoring and customizable text or email alerts available with ABB Ability™ Energy and Asset Manager



### Simplified service

- Mechanism replacement in as little as 10 minutes - only 3 replacement parts in the 30-1200A range.
- Quick swap HMI
- 95% fewer spare parts than legacy Zenith offering
- ABB HMI navigation and programming tool common to all ABB LV components



### Easier to install, commission and operate

- Color touchscreen HMI with intuitive menu navigation, measurements display, and 250 event log
- Wide 200-480V range with auto-configuration of system settings for 30-1200A range
- Ekip Connect software helps reduce commissioning time by 50%
- Five factory programmed packages available; IO can be re-programmed in seconds



### High performance

- High time-based withstand and closing ratings (WCR) and even higher coordinated WCR, minimum of 100kA in each frame
- Short-time withstand ratings in every frame
- Fast controller response to outage recovery and fast switching (<50ms)
- Overlapping neutral on 30-1200A range

---

## The world's first true ATS is here Introducing TruONE.

A critical breakthrough for critical power



---

### What makes TruOne® unique

- One unit, One wire - just like an ATS should be
- Below 50 ms in-phase transfer
- IEC/UL1008 approved
- Overlapping neutral
- ABB Ability™: Energy and asset manager
- Ekip Com modules for uniform platform
- Predictive maintenance
- Modular structure to simplify service



# Automatic transfer switches - IEC

## Ordering Information



### Delayed transition – Open style, Level 2 Level 3 & Level 4 controls

I-O-II –operation with stable OFF position between positions I and II.

Delivery includes handle for manual operation, 2 m RJ45 connection cable between detachable HMI and ATS frame.

Terminal connection kits (bolts, nuts and washers) available as accessory.

Bottom entry - Source 1 and Source 2 connections on bottom, load connections on top								
Poles	Rated current [A]	Level 2 DIP controls		Level 3 LCD controls		Level 4 Touch controls		L.P. (₹)
		Order number	Type	Order number	Type	Order number	Type	
4	200	1SCA153427R1001	OXB200E3S2QB	1SCA153429R1001	OXB200E3S3QB	1SCA153431R1001	OXB200E3S4QB	
4	250	1SCA153456R1001	OXB250E3S2QB	1SCA152435R1001	OXB250E3S3QB	1SCA152794R1001	OXB250E3S4QB	
4	315	1SCA153501R1001	OXB315E3S2QB	1SCA152046R1001	OXB315E3S3QB	1SCA153504R1001	OXB315E3S4QB	
4	400	1SCA153515R1001	OXB400E3S2QB	1SCA153517R1001	OXB400E3S3QB	1SCA152048R1001	OXB400E3S4QB	
4	500	1SCA151025R1001	OXB500E3S2QB	1SCA151741R1001	OXB500E3S3QB	1SCA150003R1001	OXB500E3S4QB	Upon request
4	630	1SCA151054R1001	OXB630E3S2QB	1SCA151057R1001	OXB630E3S3QB	1SCA151060R1001	OXB630E3S4QB	
4	800	1SCA150934R1001	OXB800E3S2QB	1SCA149958R1001	OXB800E3S3QB	1SCA149959R1001	OXB800E3S4QB	
4	1000	1SCA153577R1001	OXB1000E3S2QB	1SCA153579R1001	OXB1000E3S3QB	1SCA151491R1001	OXB1000E3S4QB	
4	1250	1SCA153610R1001	OXB1250E3S2QB	1SCA153612R1001	OXB1250E3S3QB	1SCA153614R1001	OXB1250E3S4QB	
4	1600	1SCA153622R1001	OXB1600E3S2QB	1SCA152412R1001	OXB1600E3S3QB	1SCA152414R1001	OXB1600E3S4QB	

# Enclosed automatic transfer switches - IEC

## Ordering Information



### Delayed transition - Enclosed style, Level 3 LCD controls

I-O-II –operation with stable OFF position between positions I and II.

Delivery includes steel sheet enclosure, handle for manual operation, PE-terminal, neutral bar (3 pole versions), transparent IP54 protection cover and bolt kit with nuts and washers for all terminals. Enclosure rating IP54 and 4 mounting brackets for wall mounting included in the delivery. Cable connections from the bottom, one large cable entry flange on bottom side, top side blank and door with 2 locks. Color RAL 7035. ATS manually operable without opening the door.

All cable entries from bottom - source 1, source 2 and load						
Poles	Rated current [A]	Level 3 LCD controls		Level 4 Touch controls		L.P. (₹)
		Order number	Type	Order number	Type	
4	200	1SCA157160R1001	OXB200E3S3Q54B	1SCA157161R1001	OXB200E3S4Q54B	
4	250	1SCA157162R1001	OXB250E3S3Q54B	1SCA157010R1001	OXB250E3S4Q54B	
4	315	1SCA157163R1001	OXB315E3S3Q54B	1SCA157164R1001	OXB315E3S4Q54B	
4	400	1SCA157165R1001	OXB400E3S3Q54B	1SCA157011R1001	OXB400E3S4Q54B	
4	630	1SCA151056R1001	OXB630E3S3Q54B	1SCA151059R1001	OXB630E3S4Q54B	Upon request
4	800	1SCA150936R1001	OXB800E3S3Q54B	1SCA150936R1001	OXB800E3S3Q54B	
4	1000	1SCA153649R1001	OXB1000E3S3Q54B	1SCA153650R1001	OXB1000E3S4Q54B	
4	1250	1SCA153653R1001	OXB1250E3S3Q54B	1SCA153654R1001	OXB1250E3S4Q54B	

# Compact ATS

## Automatic transfer switches, I - O - II operation

Supplied with bridging bars and direct mounted handle



Rated current In [A]	Pole	Description	Ordering code	L.P.(₹)
63	3	OTM63F3C20D400C	1SYN151423R1001	51,620
125		OTM125F3C20D400C	1SYN151423R1003	74,590
63		OTM63F3C21D400C	1SYN151423R1002	57,860
125		OTM125F3C21D400C	1SYN151423R1004	84,330



Rated current In [A]	Pole	Description	Ordering code	L.P.(₹)
40	4	OTM40F4C20D400C	1SYN151252R1001	51,340
63		OTM63F4C20D400C	1SYN151254R1001	77,970
125		OTM125F4C20D400C	1SYN151250R1001	77,970
40		OTM40F4C21D400C	1SYN151253R1001	54,030
63		OTM63F4C21D400C	1SYN151255R1001	81,610
125		OTM125F4C21D400C	1SYN151251R1001	81,610
40		OTM40F4CB21D400C	1SYN150580R1001	63,650
63		OTM63F4CB21D400C	1SYN150586R1001	92,200
125	OTM125F4CB21D230C	1SYN150574R1001	92,200	

Note:

- For 2 pole requirement contact nearest sales office

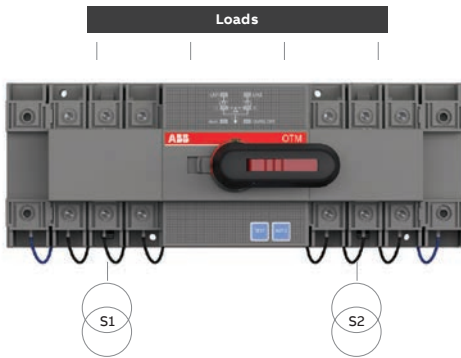

OTM\_C20D:

- For Network/Network application
- Fixed version with pre-defined delay times and voltage thresholds

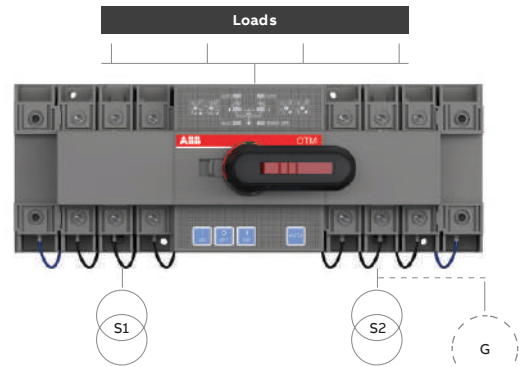

OTM\_C21D

- For Network/Network and Network/Genset applications
- Adjustable version with configurable transfer and back-switching delays Adjustable over and under-voltage thresholds

# OT automatic transfer switches

## Automatic transfer switches, I - O - II operation

Supplied as package solution with switch & OMD



Automatic operation, equipped with OMD300 controller unit with integrated dual power supply

Rated current In [A]	Poles	Description	Ordering code	L.P.(₹)
160	4	OTM160E4C3D230C	1SYN106305R1001 ■ *	1,33,100
200		OTM200E4C3D230C	1SYN106309R1001 *	1,37,570
250		OTM250E4C3D230C	1SYN106313R1001 *	1,42,060
315		OTM315E4C3D230C	1SYN106317R1001 *	1,48,800
400		OTM400E4C3D230C	1SYN106318R1001 ■ *	1,59,970
630		OTM630E4C3D230C	1SYN108726R1001 *	2,09,340
800		OTM800E4C3D230C	1SYN108728R1001 *	2,76,640
1000		OTM1000E4C3D230C	1SYN112852R1001 *	2,99,080
1250		OTM1250E4C3D230C	1SYN112851R1001 *	3,63,380
1600		OTM1600E4C3D230C	1SYN112848R1001 *	4,48,590

\* Automatic Transfer Switches 1SYN... code include the following:

- OTM160...1600\_CM\_ motorized change-over switch - 1 no.
- Bridging bar - 1 no.
- OMZB\_ voltage sensing connectors - 1 no.
- OA1G10 auxiliary contacts - 2 no.
- OMD300E480C-A1 - 1 no.



# OT manual changeover switches

## Manual changeover switches, I-O-II -operation

Supplied with bridging bars, extended shaft and IP 65 pistol type handle



Rated current In [A]	Poles	Description	Ordering code	L.P.(₹)	Poles	Description	Ordering code	L.P.(₹)
16	3	OT16F3C	1SYN104816R1001 ■	4,390	4	OT16F4C	1SYN104831R1001	5,540
25		OT25F3C	1SYN104863R1001 ■	5,540		OT25F4C	1SYN104877R1001	6,240
40		OT40F3C	1SYN104913R1001 ■	6,020		OT40F4C	1SYN104934R1001 ■	6,880
63		OT63F3C	1SYN105338R1001 ■	7,830		OT63F4C	1SYN105369R1001 ■	8,870
80		OT80F3C	1SYN105402R1001	8,610		OT80F4C	1SYN105418R1001 ■	9,840
100		OT100F3C	1SYN105008R1001 ■	11,520		OT100F4C	1SYN105019R1001	13,190
125		OT125F3C	1SYN105037R1001 ■	12,070		OT125F4C	1SYN105054R1001 ■	14,030
160		OT160E03CP	1SYN022772R6510 ■	16,670		OT160E04CP	1SYN022775R9440 ■	19,550
200		OT200E03CP	1SYN022771R7520 ■	17,230		OT200E04CP	1SYN022771R7280 ■	20,130
250		OT250E03CP	1SYN022771R3450 ■	21,500		OT250E04CP	1SYN022775R4640 ■	24,950
315		OT315E03CP	1SYN022772R6780 ■	25,290		OT315E04CP	1SYN022775R7150 ■	30,470
400		OT400E03CP	1SYN022771R8500 ■	31,010		OT400E04CP	1SYN022771R8680 ■	35,840
630		OT630E03CP	1SYN022785R6050 ■	44,830		OT630E04CP	1SYN022785R6130 ■	55,180
800		OT800E03CP	1SYN022785R6300	57,470		OT800E04CP	1SYN022785R6210 ■	66,660
1000		OT1000E03CP	1SYN022872R1680 ■	1,55,160		OT1000E04CP	1SYN022872R1500	1,78,140
1250		OT1250E03CP	1SYN022872R0790	1,72,390		OT1250E04CP	1SYN022872R1250	1,93,210
1600	OT1600E03CP	1SYN022872R1840	2,12,610	OT1600E04CP	1SYN022872R2310	2,38,530		
2000	OT2000E03CP	1SYN103908R1001	3,21,810	OT2000E04CP	1SYN103912R1001	4,13,720		
2500	OT2500E03CP	1SYN105615R1001	3,50,530	OT2500E04CP	1SYN103906R1001	4,51,030		
3200	OT3200E03CP	1SYN129156R1001	5,05,670	OT3200E04CP	1SYN129158R1001	6,03,360		

Note: Contact our nearest sales office

1. For 6 pole change over
2. For manual/motorized bypass switch
3. For manual closed transition
4. For wide phase manual change over

# OT motorized changeover switches



## Changeover switches, motor operation, I-O-II -operation

Supplied with bridging bars and handle

Rated current In [A]	Poles	Description	Ordering code	L.P.(₹)	Poles	Description	Ordering code	L.P.(₹)
40	3	OTM40F3CMA230V	1SYN120096R1001	38,060	4	OTM40F4CMA230V	1SYN120102R1001	40,980
63		OTM63F3CMA230V	1SYN120095R1001	40,230		OTM63F4CMA230V	1SYN120101R1001 ■	43,170
80		OTM80F3CMA230V	1SYN120093R1001	43,890		OTM80F4CMA230V	1SYN120100R1001	45,360
100		OTM100F3CMA230V	1SYN120071R1001	46,070		OTM100F4CMA230V	1SYN120098R1001 ■	46,840
125		OTM125F3CMA230V	1SYN120070R1001	47,550		OTM125F4CMA230V	1SYN120097R1001 ■	49,760
160		OTM160E3CM230C	1SYN022845R8610	64,110		OTM160E4CM230C	1SYN022848R1510 ■	67,070
200		OTM200E3CM230C	1SYN022845R8960	66,560		OTM200E4CM230C	1SYN022846R1590 ■	69,050
250		OTM250E3CM230C	1SYN022845R9260	82,100		OTM250E4CM230C	1SYN022846R1910 ■	84,540
315		OTM315E3CM230C	1SYN022847R1210	82,980		OTM315E4CM230C	1SYN022847R2870 ■	86,310
400		OTM400E3CM230C	1SYN022847R1630	99,850		OTM400E4CM230C	1SYN022847R3250 ■	1,08,330
630		OTM630E3CM230C	1SYN103567R1001	1,33,660		OTM630E4CM230C	1SYN022873R1990 ■	1,37,940
800		OTM800E3CM230C	1SYN103570R1001	1,79,080		OTM800E4CM230C	1SYN022872R8340 ■	1,87,000
1000		OTM1000E3CM230C	1SYN112677R1001	2,39,800		OTM1000E4CM230C	1SYN112703R1001	2,43,660
1250		OTM1250E3CM230C	1SYN112676R1001	2,85,990		OTM1250E4CM230C	1SYN112702R1001	2,90,420
1600		OTM1600E3CM230C	1SYN112678R1001	3,52,180		OTM1600E4CM230C	1SYN112704R1001	3,64,690
2000		OTM2000E3CM230C	1SYN112709R1001	5,10,110		OTM2000E4CM230C	1SYN112712R1001	5,56,870
2500		OTM2500E3CM230C	1SYN112710R1001	5,85,760		OTM2500E4CM230C	1SYN112713R1001	6,35,140

Note:

Motor voltage Ue 110-240 V AC/DC (OTM40...125A)

Motor voltage Ue 220-240 V AC (OTM160...2500A)

OMD control units can be purchased separately for their motorized changeover switches in order to build an ATS by themselves. Contact nearest sales office for making selection.

Contact our nearest sales office:

- For motor voltage Ue 110...125 V AC/DC (160A-2500A)
- For motor voltage Ue = 48V DC (160A-2500A)

## Accessories for changeovers (manual, motorized, ATS)



### Shaft

Frame	Description	Ordering code	L.P. (₹)	Handle	Description	Ordering code	L.P. (₹)
OT16...125F_C	EXP6X170	1SCA108224R1001	450	OHB45J6E311	1SCA022817R2130 ■	2,780	
OT160...250_C	EXP6x161	1SCA022067R176 ■	450	OHB65J6E011	1SCA022383R2480 ■	3,100	
OT315...400_C	EXP12x166	1SCA022325R671	690	OHB95J12E011	1SCA022621R0760 ■	3,520	
OT630...800_C				OHB125J12E011	1SCA022589R3340 ■	3,910	
OT630...3200_C	EXP12x185	1SCA022325R710 ■	820	OHB200J12PE011	1SCA022873R4230	8,560	

### Auxiliary contacts

Frame	Contact functions	Installation side	Description	Ordering code	L.P. (₹)
OT16...125F_C OTM40...125	1NO	Right	OA1G10	1SCA022353R497	700
	1NC	Right	OA8G01	1SCA022744R224 ■	1,260
	1NO	Left	OA7G10	1SCA022673R114 ■	1,110
	1NC	Left	OA1G01	1SCA022353R489	700
OT160...3200 OTM160...2500	1NO	Right	OA1G10	1SCA022353R4970	700
	1NC	Right	OA3G01	1SCA022456R7410	780

### Phase barriers

3-pole change-overs need 8 barriers and 4-pole change-overs need 12 barriers for full protection.

Frame	Poles	Description	Ordering code	L.P. (₹)
OT160...800 OTM160...800	3	PB100 low	1SDA054970R1	1,470
	4	PB100 low	1SDA054971R1	2,100

### Basic ATS controller for motorised change over

Frame	Description	Ordering code	L.P. (₹)
40...2500A	ODPS230	1SCA122946R1001 ■	16,140

Note: Contact our nearest sales office for more information

■ Stock items

---

# Kabeldon low voltage switchgear system



---

Features of the Kabeldon IP-system are its simplicity and reliability. These are the most important factors when you want to achieve low operating costs and high delivery reliability in a distribution system.

- Busbars of continuously-extruded aluminium sections, insulated with a layer of polyamid.
- The busbar has a touch-proof contact slot.
- Blade fuses in all of the fuse-switch disconnectors.
- The switching devices can be arranged in any order, regardless of rated current.
- All parts, busbars and devices, fulfil IP2X protection in accordance with IEC 60529\*).
- Switching devices 100-1600 A.
- It is easy to add new switching devices to existing distribution boards.
- Switching devices are mounted on and connected to the busbar system in the same operation.
- Switching devices can be connected when the system is live.
- Always voltage-free (“dead”) when changing fuses.
- Busbars are available with rated currents from 400 to 1600 A.
- Switching devices, connectors and busbars combine to form a modular system. Each module is 12.5 mm. The modular system makes planning easier.
- The compact design of the switching devices makes them suitable for use in many different types of distribution boards.
- All switching devices have a utilisation category.

# ABB's comprehensive range of LV control products

The range of ABB control products ranks amongst the most extensive on the market with a full range of innovative solutions for control & protection, motor starting, intelligent motor management, measurement and monitoring and safety applications.

The business unit is comprised of 3 main product families:

- Control & protection
- Electronic relays
- Safety products

## Our products

Our products are already among the most extensive in the market and we are constantly adding new products in order to meet ever changing customer needs. Quality and reliability are built into every device to ensure total performance satisfaction, even in the most demanding applications.

We offer a very modern and competitive range of contactors, starters, manual motor starters, a wide range of electronic relays and overload relays, together with an extended of pilot devices.

## Our offering

- Contactors
- Manual motor starters
- Thermal overload relays
- Electronic overload relays
- Intelligent motor management systems
  - Universal motor controllers
  - Communication fieldbus plugs
- Electronic products and relays
  - Timers
  - Measuring and monitoring relays
  - Power supplies
  - Interface relays & optocouplers
- Jokab safety systems
- Pilot devices
- Softstarters
- Hybrid starters



# Motor starting and protection

Keep things moving with protection and control - at every level.

Our broad portfolio of motor starting and protection solutions are fully scalable, allowing you to keep things moving whatever the extent of your operations.

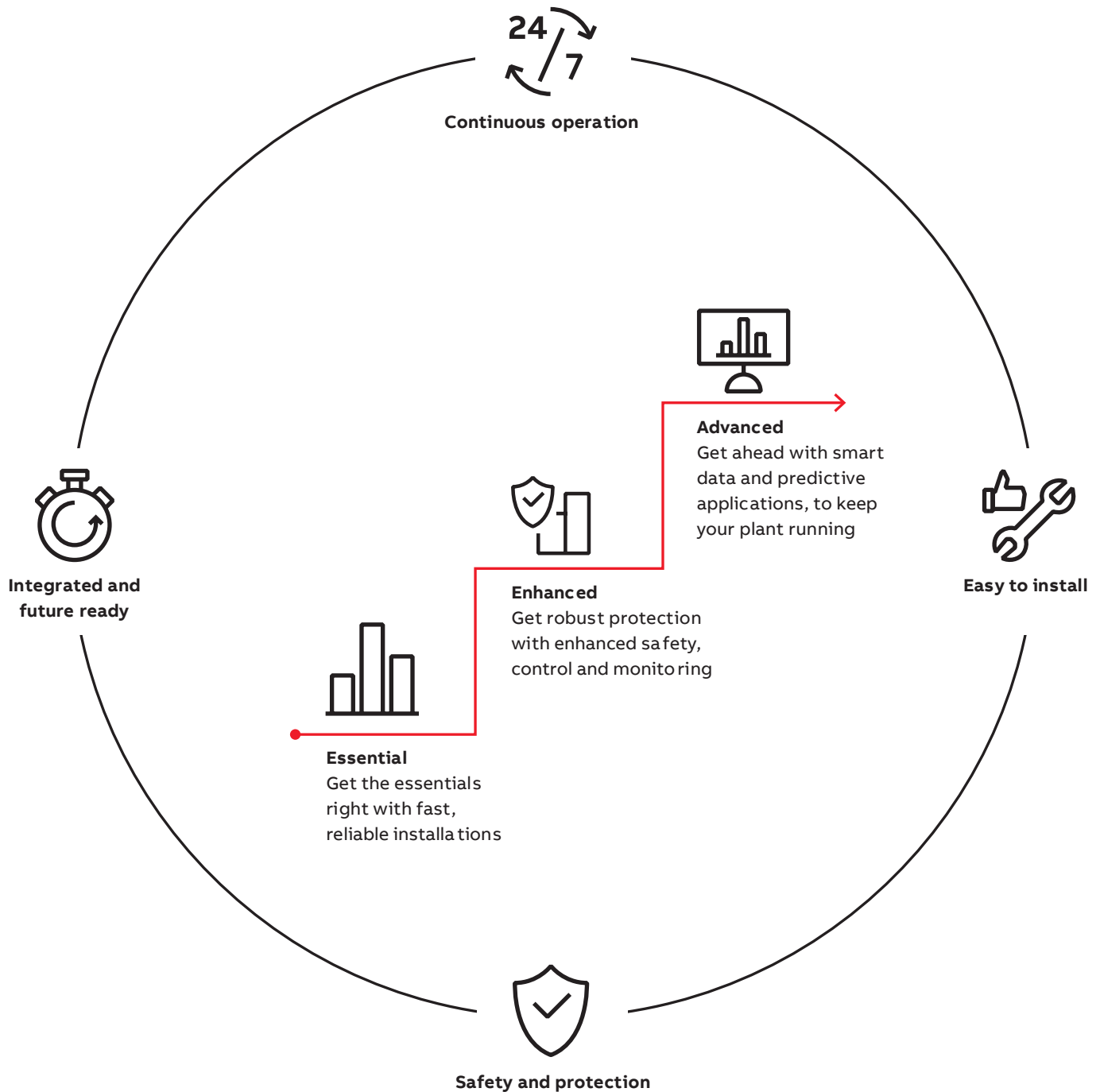

# Enhanced solutions

Get robust protection with enhanced safety, control and monitoring

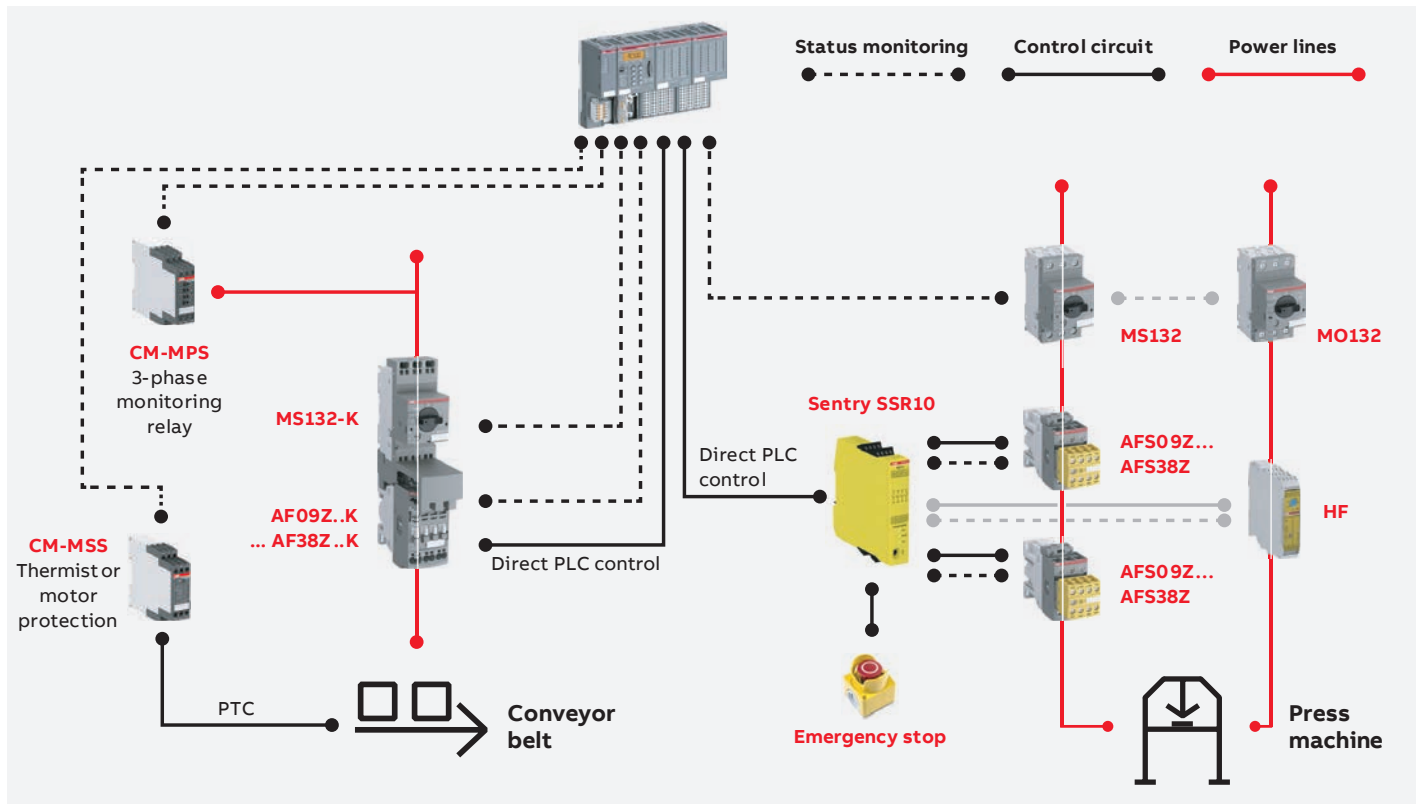

## Safety and protection

Enhanced safety and protection for solutions with higher specification requirements.

- Integration in machine manufacturer's systems complying with main standards EN ISO 13849, EN 62061 and IEC / EN 61508
- Trouble-free and economic operation of machines and installations thanks to the monitoring of all important parameters in your three-phase network
- Prevent overheating, overload and insufficient cooling. Irregularities are signaled early to avoid plant downtime



## Speed up your projects

Reduce time in planning, designing, assembly and delivery of custom panels to market.

- Use the same starters in Europe, Asia and North America as one contactor coil now handles 100 V – 250 V AC / DC, 50 / 60 Hz
- Push-in Spring allows you to insert both ferruled and rigid cables without the need to use any tools, boosting your productivity like never before
- With more than 1800 tested and validated coordination tables available in the SOC tool, you can quickly and easily choose the right ABB solution

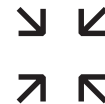

## Space-saving

Space is usually very limited for control panels, but our compact solutions are designed to easily fit into your application.

- Motor starters can be controlled directly by PLC thanks to AF contactor versions with low consumption coil, external or built-in PLC interface. No need for interface relays, which requires extra space
- Motor starters up to 3 kW / 3 hp require 90 % less space thanks to ABB's HF electronic compact starter. At just 22.5 mm width, it still provides motor starting functionalities with embedded protection and safety



## Advanced solutions

Get ahead with intelligent, predictive operations thanks to integrated data and advanced connectivity



**Universal motor controller UMC100.3**

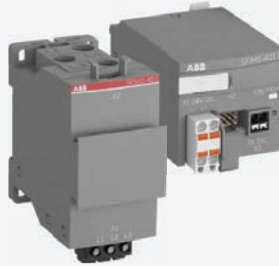

**Novolink modules for AF contactors**



**Softstarter PTSX**



### Integrated and future ready

Data and precise measurements accessible via flexible communication options ensure reliable operations and efficient energy management. Adapt to future needs without big investments.

- The UMC100.3 is compatible with more communication protocols than any other motor controller. This allows you to have software that enables predictive maintenance and acts as an intelligent data hub



### Continuous operation

Detect problems earlier and prevent plant stand-stills with integrated protection functions as well as extensive diagnostic and status information.

- Protect your motors at all times with the UMC100.3, even if your control or communication system (Ethernet or Fieldbus) breaks down
- Softstarters help increase your motors lifetime by protecting it from electrical stress. Starting currents are easily optimized to your load, application and motor size



### Speed up your project

Design, commissioning, and maintenance are easy, cutting costs and saving you time. ABB's flexible designs allow you to have a tailor-made solution.

- With the UMC100.3, simple software configuration means that you are always in control. Parameters can be set via quality FDI-based software or directly using the operating panel
- Reduce your installation time and panel size by having all features you need built into your softstarter

# Advanced solutions

## UMC100.3 application example

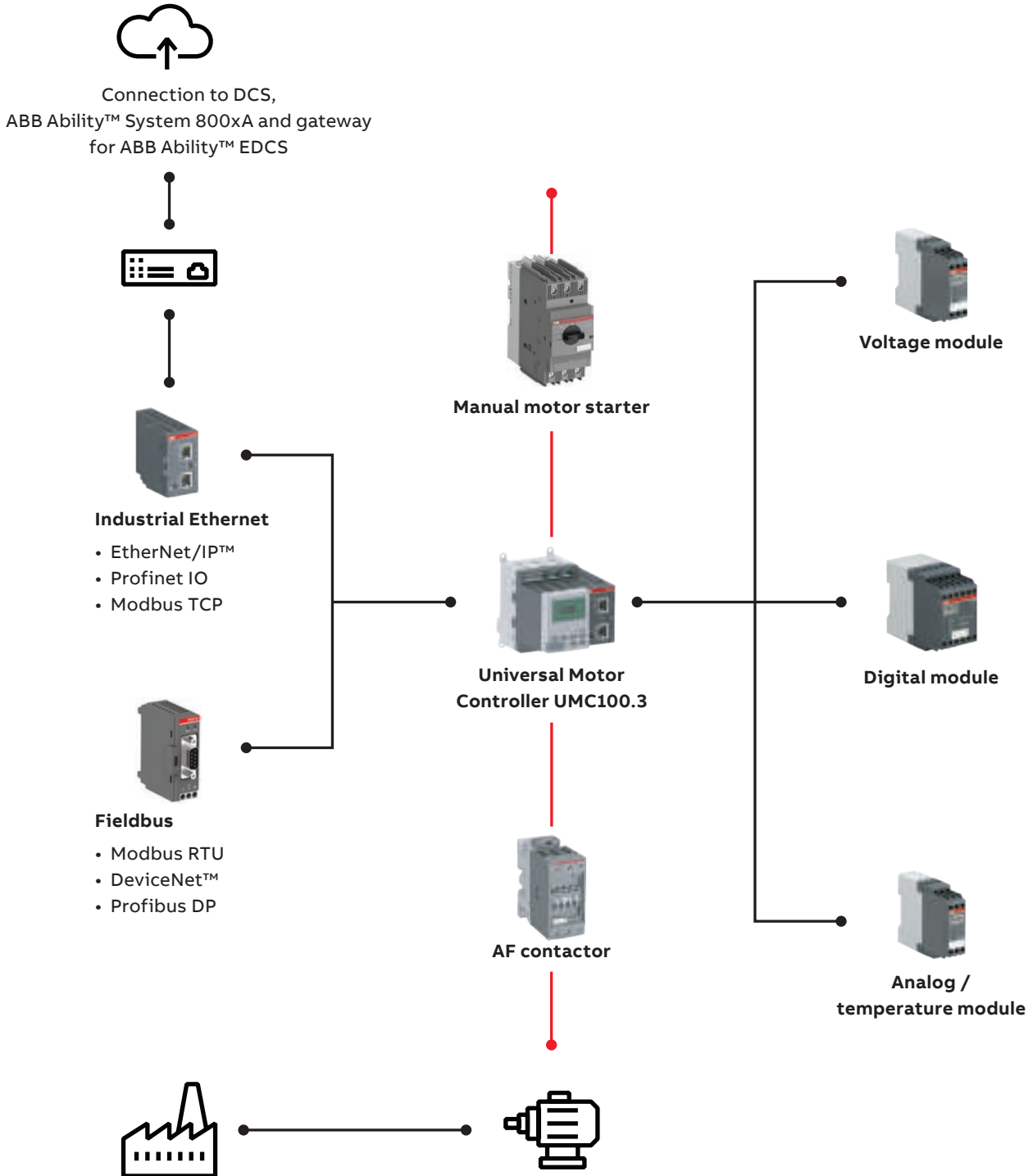

# Complete solutions for control panels

ABB's broad portfolio offers all you need for your application, at every level.

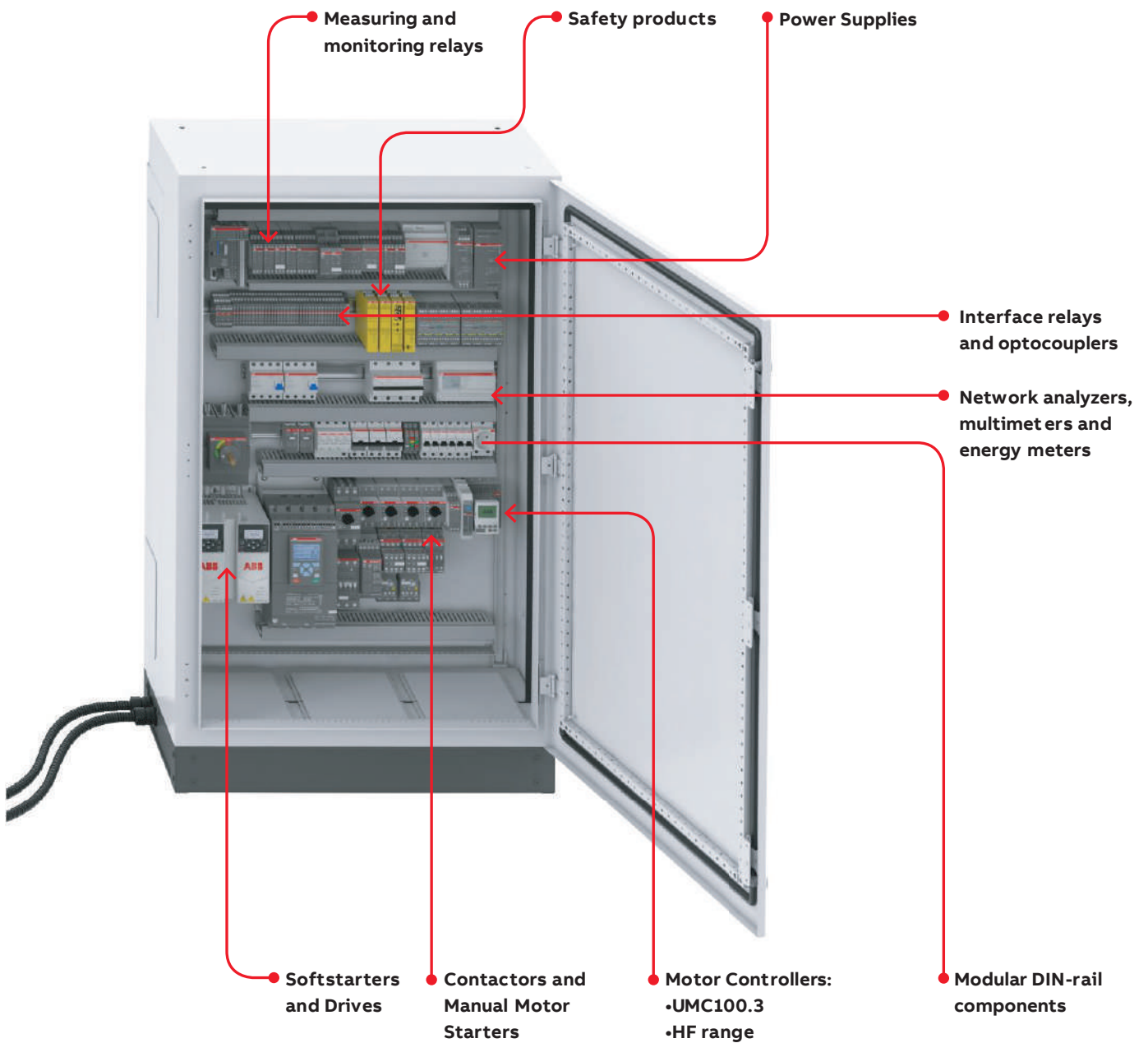

# Auxiliary contactors

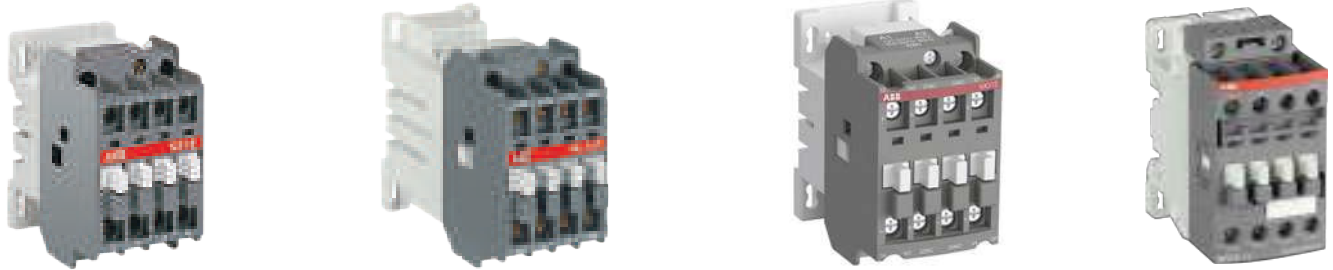

## Standard control contactors

No. of contacts	Contact configuration		Type code reference	Ordering code	L.P.(₹)	Type code reference	Ordering code	L.P.(₹)
	NO	NC						
4	2	2	N22E **	1SBH141001R□□22 ■	1,620	NL22E **	1SBH143001R□□22 ■	2,470
4	3	1	N31E **	1SBH141001R□□31 ■		NL31E **	1SBH143001R□□31 ■	
4	4	0	N40E **	1SBH141001R□□40 ■		NL40E **	1SBH143001R□□40 ■	

Refer Page 74 for accessories

No. of contacts	Contact configuration		Type code reference	Ordering code	L.P.(₹)
	NO	NC			
4	2	2	NX22E	1SBH901074R□□22 ■	1,330
4	3	1	NX31E	1SBH901074R□□31 ■	
4	4	0	NX40E	1SBH901074R□□40 ■	

Refer Page 75 for accessories

## Wide band AC / DC operated

No. of contacts	Contact configuration		Type code reference	Ordering code	L.P.(₹)
	NO	NC			
4	2	2	NF22E **	1SBH137001R□□22 ■	2,950
4	3	1	NF31E **	1SBH137001R□□31 ■	
4	4	0	NF40E **	1SBH137001R□□40 ■	

Refer coil voltage & codes mentioned below.

## Wide band low power consumption

Type code reference #	Ordering code	L.P.(₹)
NFZ31E **	1SBH136001R□□31	
NFZ40E **	1SBH136001R□□40	

#Allows direct control by PLC output ≥ 24 V DC 500 mA

## Coil voltages and codes

### N & NX range (AC operated)

Voltage	Voltage	Code
V - 50Hz	V - 60Hz	□□
24	24	8 1 ■
110	110 ... 120	8 4 ■
220 ... 230	230 ... 240	8 0 ■
400 ... 415	415 ... 440	8 6 ■

### NF range (AC/DC operated)

Voltage	Voltage	Code
V 50/60 Hz	V DC	□□
24...60	20...60	1 1 ■
48...130	48...130	1 2 ■
100...250	100...250	1 3 ■
250...500	250...500	1 4 ■

### NL (DC operated)

Voltage V DC	Code
□□	□□
24	8 1 ■
48	8 3 ■
110	8 6 ■
220	8 8 ■

### NFZ range (AC/DC operated)

Voltage V 50/60 Hz	Voltage V DC	Code
□□	□□	□□
-	12...20	2 0
24...60	20...60	2 1
48...130	48...130	2 2
100...250	100...250	2 3

■ Stock items

# 3 pole contactors: AX09...AX370 : AC operated



AX09



AX95



AX185



AX370

## AX Contactor

AX contactors are mainly used for controlling 3-phase motors and power circuits up to 690 V AC. These contactors are of the block type design with:

- 3 main poles and built-in auxiliary contact
- Control circuit: AC operated
- Add-on auxiliary contact blocks for front or side mounting and a wide range of accessories

## Contactors: 3-pole – AC operated

AC1 duty Amps	AC3 rating at 415V		Auxiliary contacts	Type code	Ordering code	L.P.(₹)
	Amps	kW				
22	9	4	1NO -	AX09-30-10	1SBL901074R□□10 ■	1,330
22	9	4	- 1NC	AX09-30-01	1SBL901074R□□01 ■	1,330
25	12	5.5	1NO -	AX12-30-10	1SBL911074R□□10 ■	1,470
25	12	5.5	- 1NC	AX12-30-01	1SBL911074R□□01 ■	1,470
27	18	9	1NO -	AX18-30-10	1SBL921074R□□10 ■	1,660
27	18	9	- 1NC	AX18-30-01	1SBL921074R□□01 ■	1,660
32	25	11	1NO -	AX25-30-10	1SBL931074R□□10 ■	2,280
32	25	11	- 1NC	AX25-30-01	1SBL931074R□□01 ■	2,280
55	32	15	1NO -	AX32-30-10	1SBL281074R□□10 ■	4,870
55	32	15	- 1NC	AX32-30-01	1SBL281074R□□01 ■	4,870
60	40	18.5	1NO -	AX40-30-10	1SBL321074R□□10 ■	7,610
60	40	18.5	- 1NC	AX40-30-01	1SBL321074R□□01 ■	7,610
100	50	25	1NO 1NC	AX50-30-11	1SBL351074R□□11 ■	10,030
115	65	30	1NO 1NC	AX65-30-11	1SBL371074R□□11 ■	13,650
125	80	37	1NO 1NC	AX80-30-11	1SBL411074R□□11 ■	16,350
145	96	45	1NO 1NC	AX95-30-11	1SFL431074R□□11 ■	19,950
160	115	55	1NO 1NC	AX115-30-11	1SFL981074R□□11 ■	25,480
190	150	75	1NO 1NC	AX150-30-11	1SFL991074R□□11 ■	33,760
250	185	90	1NO 1NC	AX185-30-11	1SFL491074R□□11 ■	39,630
275	205	110	1NO 1NC	AX205-30-11	1SFL501074R□□11 ■	46,330
400	265	132	1NO 1NC	AX260-30-11	1SFL547074R□□11 ■	62,850
500	305	160	1NO 1NC	AX300-30-11	1SFL587074R□□11 ■	73,740
600	370	200	1NO 1NC	AX370-30-11	1SFL607074R□□11 ■	93,640

Note: Complete the contactor code by replacing □□ with desired coil voltages as per above table.

Refer Page 75 for accessories

## Coil voltages and codes AX range

Voltage	Voltage	Code
□□ V - 50Hz	□□ V - 60Hz	□□
24	24	8 1 ■
110	110	8 4 ■
220 ... 230	220 ... 230	8 0 ■
400 ... 415	400 ... 415	8 6 ■

# 3 pole contactors: AC operated



## Contactors: 3-pole – AC operated

AC1duty Amps	AC3 rating at 415V			Auxiliary contacts		Type code	Ordering code	L.P.(₹)
	Amps	hP	kW					
25	9	5.5	4	1NO	-	A09-30-10 **	1SBL141001R□□10 ■	1,500
25	9	5.5	4	-	1NC	A09-30-01 **	1SBL141001R□□01 ■	1,500
27	12	7.5	5.5	1NO	-	A12-30-10 **	1SBL161001R□□10 ■	1,680
27	12	7.5	5.5	-	1NC	A12-30-01 **	1SBL161001R□□01 ■	1,680
30	17	12.5	7.5	1NO	-	A16-30-10 **	1SBL181001R□□10 ■	1,930
30	17	12.5	7.5	-	1NC	A16-30-01 **	1SBL181001R□□01 ■	1,930
45	26	15	11	1NO	-	A26-30-10 **	1SBL241001R□□10 ■	2,730
45	26	15	11	-	1NC	A26-30-01 **	1SBL241001R□□01 ■	2,730
55	32	20	15	1NO	-	A30-30-10 **	1SBL281001R□□10 ■	5,530
55	32	20	15	-	1NC	A30-30-01 **	1SBL281001R□□01 ■	5,530
60	37	30	18.5	1NO	-	A40-30-10 **	1SBL321001R□□10 ■	8,430
60	37	30	18.5	-	1NC	A40-30-01 **	1SBL321001R□□01 ■	8,430
100	50	40	25	-	-	A50-30-00 **	1SBL351001R□□00 ■	10,710
115	65	50	37	-	-	A63-30-00 **	1SBL371001R□□00 ■	14,910
125	75	60	40	-	-	A75-30-00 **	1SBL411001R□□00 ■	18,890
145	96	70	55	1NO	1NC	A95-30-11**	1SFL431001R□□11 ■	24,860
160	110	75	59	1NO	1NC	A110-30-11**	1SFL451001R□□11 ■	31,030
250	145	100	75	1NO	1NC	A145-30-11**	1SFL471001R□□11 ■	39,980
275	185	115	90	1NO	1NC	A185-30-11**	1SFL491001R□□11 ■	50,340
350	205	150	110	1NO	1NC	AF205-30-11**	1SFL527002R□□11 ■	54,890
400	265	175	140	1NO	1NC	AF265-30-11**	1SFL547002R□□11 ■	65,840
500	305	215	160	1NO	1NC	AF305-30-11**	1SFL587002R□□11 ■	77,840
600	370	270	200	1NO	1NC	AF370-30-11**	1SFL607002R□□11 ■	95,970
600	400	300	220	1NO	1NC	AF400-30-11**	1SFL577001R□□11 ■	1,02,080
700	460	340	250	1NO	1NC	AF460-30-11**	1SFL597001R□□11 ■	1,36,330
800	580	470	355	1NO	1NC	AF580-30-11**	1SFL617001R□□11 ■	2,13,180
1050	750	570	425	1NO	1NC	AF750-30-11**	1SFL637001R□□11 ■	
1260	-	-	-	1NO	1NC	AF1250-30-11**	1SFL647001R□□11	
1350	860	-	500	1NO	1NC	AF1350-30-11**	1SFL657001R□□11	
1650	1050	-	600	1NO	1NC	AF1650-30-11**	1SFL677001R□□11	Upon request
2050	-	-	-	1NO	1NC	AF2050-30-11**	1SFL707001R□□11	
2650	-	-	-	1NO	1NC	AF2650-30-11**	1SFL667001R□□11	
2850	-	-	-	1NO	1NC	AF2850-30-11**	1SFL687001R□□11	

Complete the contactor type code by replacing \*\* with desired coil voltage, AF contactors have advanced electronic coil interface with wideband AC/DC coil  
Refer Page 74 and Page 82 for accessories

### Coil voltages and codes: A09 ... A185 range

Voltage	Voltage	Code
□□ V - 50Hz	□□ V - 60Hz	□□
24	24	8 1 ■
110	110 ... 120	8 4 ■
220 ... 230	230 ... 240	8 0 ■
400 ... 415	415 ... 440	8 6 ■

### New AF205...AF370 range (AC/DC operated)

Voltage	Voltage	Code
V 50/60 Hz	V DC	□□
24...60	20...60	1 1
48...130	48...130	1 2
100...250	100...250	1 3
250...500	250...500	1 4

### AF400...AF1250 range (AC/DC operated)

Voltage	Voltage	Code
V 50/60 Hz	V DC	□□
-	24...60	6 8
48...130	48...130	6 9
100...250	100...250	7 0
250...500	250...500	7 1

### AF1350...AF2850 range (AC/DC operated)

Voltage	Voltage	Code
V 50/60 Hz	DC	□□
100...250	100...250	7 0

Note: For non-standard coil voltage, other than this contact us for price.

# 4 pole contactors: AC operated



## Contactors: 4-pole (AC operated)

Rating at 415V AC1 Amps	Main contact arrangement		Auxiliary contacts		Type code reference	Ordering code	L.P.(₹)
25	4NO	-	-	-	A09-40-00 **	1SBL141201R□□00 ■	1,900
25	2NO	2NC	-	-	A09-22-00 **	1SBL141501R□□00 ■	2,250
30	4NO	-	-	-	A16-40-00 **	1SBL181201R□□00 ■	2,010
30	2NO	2NC	-	-	A16-22-00 **	1SBL181501R□□00 ■	2,380
45	4NO	-	-	-	A26-40-00 **	1SBL241201R□□00 ■	3,640
45	2NO	2NC	-	-	A26-22-00 **	1SBL241501R□□00 ■	4,550
70	4NO	-	-	-	A45-40-00**	1SBL331201R□□00 ■	10,010
70	2NO	2NC	-	-	A45-22-00**	1SBL331501R□□00	14,030
100	4NO	-	-	-	A50-40-00**	1SBL351201R□□00 ■	14,560
125	4NO	-	-	-	A75-40-00**	1SBL411201R□□00 ■	19,370
125	2NO	2NC	-	-	A75-22-00**	1SBL411501R□□00	22,190
160	4NO	-	-	-	AF116-40-00	1SFL427102R□□00	37,670
200	4NO	-	-	-	AF140-40-00	1SFL447102R□□00	42,770
275	4NO	-	-	-	AF190-40-00	1SFL487102R□□00 ■	58,360
350	4NO	-	-	-	AF205-40-00	1SFL527102R□□00 ■	69,590
400	4NO	-	-	-	AF265-40-00	1SFL547102R□□00 ■	83,460
500	4NO	-	-	-	AF305-40-00	1SFL587102R□□00 ■	1,05,680
525	4NO	-	-	-	AF370-40-00	1SFL607102R□□00 ■	1,17,900
800	4NO	-	1NO	1NC	EK550-40-11 **	SK827041 - □□ ■	Upon request
1000	4NO	-	1NO	1NC	EK1000-40-11 **	SK827044 - □□	Upon request

Complete the contactor type code by replacing \*\* with desired coil voltage  
Refer Page 74 & 82 for accessories

### Coil voltages and codes: A09 ... A 75 range

Voltage	Voltage	Code
<b>V - 50Hz</b>	<b>V - 60Hz</b>	□□
24	24	8 1
110	110 ... 120	8 4
220 ... 230	230 ... 240	8 0
400 ... 415	415 ... 440	8 6

### Coil voltages and codes: New AF116 - AF370 (AC/DC operated)

Voltage	Voltage	Code
<b>V 50/60 Hz</b>	<b>V DC</b>	□□
24...60	20...60	1 1
48...130	48...130	1 2
100...250	100...250	1 3
250...500	250...500	1 4

Note: For non-standard coil voltage, other than this contact us for price.

### Coil voltages and codes: EK550 ... EK1000

Voltage	Voltage	Code
<b>V - 50Hz</b>	<b>V - 60Hz</b>	□□
-	110	A E
110	120	A F
220 ... 230	*	A L ■
230 ... 240	-	A M
400 ... 415	-	A R

■ Stock items

# 3 pole contactors AL and TAL range: DC operated



## AL contactors

AC 1 duty Amps	AC3 rating at 415V		Auxiliary contacts	Type code reference	Ordering code	L.P.(₹)	
	Amps	hP					kW
25	9	5	4	1NO -	AL9-30-10	1SBL143001R□□10 ■	2,340
25	9	5	4	- 1NC	AL9-30-01	1SBL143001R□□01 ■	2,340
27	12	7.5	5.5	1NO -	AL12-30-10	1SBL163001R□□10	2,610
27	12	7.5	5.5	- 1NC	AL12-30-01	1SBL163001R□□01	2,610
30	17	10	7.5	1NO -	AL16-30-10	1SBL183001R□□10 ■	3,210
30	17	10	7.5	- 1NC	AL16-30-01	1SBL183001R□□01	3,210
45	26	20	11	1NO -	AL26-30-10	1SBL243001R□□10 ■	4,950
45	26	20	11	- 1NC	AL26-30-01	1SBL243001R□□01	4,950
55	32	25	15	1NO -	AL30-30-10	1SBL283001R□□10	9,890
55	32	25	15	- 1NC	AL30-30-01	1SBL283001R□□01	9,890
60	37	30	18.5	1NO -	AL40-30-10	1SBL323001R□□10	12,890
60	37	30	18.5	- 1NC	AL40-30-01	1SBL323001R□□01	12,890

## TAL contactors



AC 1 duty Amps	AC3 rating at 415V		Auxiliary contacts	Type code reference	Ordering code	L.P.(₹)	
	Amps	hP					kW
25	9	5	4	1NO -	TAL9-30-10	1SBL143061R□□10 ■	2,810
25	9	5	4	- 1NC	TAL9-30-01	1SBL163061R□□10 ■	2,810
27	12	7.5	5.5	1NO -	TAL12-30-10	1SBL163061R□□10	3,450
27	12	7.5	5.5	- 1NC	TAL12-30-01	1SBL163061R□□01	3,450
30	17	10	7.5	1NO -	TAL16-30-10	1SBL183061R□□10 ■	3,690
30	17	10	7.5	- 1NC	TAL16-30-01	1SBL183061R□□01 ■	3,690
45	26	20	11	1NO -	TAL26-30-10	1SBL243061R□□10 ■	5,390
45	26	20	11	- 1NC	TAL26-30-01	1SBL243061R□□01	5,390
55	32	25	15	1NO -	TAL30-30-10	1SBL283061R□□10	10,610
55	32	25	15	- 1NC	TAL30-30-01	1SBL283061R□□01	10,610
60	37	30	18.5	1NO -	TAL40-30-10	1SBL323061R□□10 ■	12,290
60	37	30	18.5	- 1NC	TAL40-30-01	1SBL323061R□□01	12,290

### Coil voltages and codes: AL

Voltage	Code
□□ V DC	□□
24	8 1
110	8 6 ■
220	8 8

### Coil voltages and codes: TAL

Voltage	Code
□□ V DC	□□
77...143	6 2 ■

Other voltages: contact nearest ABB sales office.  
Refer Page 74 for accessories



# Contactors for special application - capacitors switching



## Contactors for capacitor switching: 3 pole – AC operated:

kVAR Rating at 415V	Auxiliary contacts	Type code reference	Ordering code	L.P.(₹)
<b>Type UA..RA with in-built damping resistors:</b>				
12.5	1NO	UA16-30-10RA **	1SBL181024R□□10 ■	3,280
22	1NO	UA26-30-10RA **	1SBL241024R□□10 ■	5,460
30	1NO	UA30-30-10RA**	1SBL281024R□□10 ■	6,260
40	--	UA50-30-00RA	1SBL350024R□□00 ■	17,640
50	--	UA63-30-00RA**	1SBL371024R□□00 ■	18,970
60	--	UA75-30-00RA**	1SBL411024R□□00 ■	21,970
70	--	UA95-30-00RA**	1SFL431024R□□00 ■	22,980
80	--	UA110-30-00RA**	1SFL451024R□□00 ■	28,010

Type UA..RA with in-built damping resistors

Complete the contactor type code by replacing \*\* with desired coil voltage.

## Peak current $\hat{I} \leq 100$ times the rms current

kVAR rating at 415V	Max peak current $\hat{I}$	Auxiliary contacts fitted		Type	Ordering code	L.P.(₹)
		NO	NC			
kvar	kA					
12.5	1.8	1	0	UA16-30-10	1SBL181022R□□10 ■	2,830
20	3	1	0	UA26-30-10	1SBL241022R□□10 ■	3,500
27.5	33.5	1	0	UA30-30-10	1SBL281022R□□10 ■	6,010
33	5	0	0	UA50-30-00	1SBL351022R□□00 ■	13,750
45	6.5	0	0	UA63-30-00	1SBL371022R□□00 ■	14,480
50	7.5	0	0	UA75-30-00	1SBL411022R□□00 ■	17,300
65	9.3	1	1	UA95-30-11	1SFL431022R□□11 ■	21,710
75	10.5	1	1	UA110-30-11	1SFL451022R□□11 ■	27,810

## Single step - Peak current $\hat{I} \leq 30$ times the RMS current

kVAR Rating at 415V	Type code	Ordering code	L.P.(₹)
60	A95-30-11**	1SFL431001R□□11 ■	24,860
70	A110-30-11**	1SFL451001R□□11 ■	31,030
90	A145-30-11**	1SFL471001R□□11 ■	39,980
110	A185-30-11**	1SFL491001R□□11 ■	50,340
130	AF205-30-11**	1SFL527002R□□11 ■	54,890
145	AF265-30-11**	1SFL547002R□□11 ■	65,840
165	AF305-30-11**	1SFL587002R□□11 ■	77,840
200	AF370-30-11**	1SFL607002R□□11 ■	1,01,270
210	AF400-30-11**	1SFL577001R□□11 ■	1,02,080
240	AF460-30-11**	1SFL597001R□□11 ■	1,36,330
285	AF580-30-11**	1SFL617001R□□11 ■	2,13,180
400	AF750-30-11**	1SFL637001R□□11 ■	Upon request

Note: Refer Page 74 & 82 for accessories

## Coil voltages and codes UA...RA & UA

Voltage	Voltage	Code
V - 50Hz	V - 60Hz	□□
24	24	8 1 ■
110	110 ... 120	8 4 ■
220 ... 230	230 ... 240	8 0 ■
400 ... 415	415 ... 440	8 6 ■

■ Stock items

# Contactors for DC circuit switching: AC/DC operated

Coil	Current ratings at 440V DC			Type code reference	Ordering code	L.P.(₹)
	DC-1	DC-3	DC-5			
AC	100A	85A	50A	GA75-10-11 **	1SBL411025R□□11	Upon request
DC	100A	85A	50A	GAE75-10-11 **	1SBL419025R□□11	

Complete the contactor type code by replacing \*\* with desired coil voltage

Coil	Current ratings at 1000V DC		Type code reference	Ordering code	L.P.(₹)
	DC-1 L/R 1 ms				
AC/DC	275A		GAF185-10-11	1SFL497025R□□11	Upon request
	450A		GAF300-10-11	1SFL557025R□□11	
	700A		GAF460-10-11	1SFL597025R□□11	
	1050A		GAF750-10-11	1SFL637025R□□11	
	1250A		GAF1250-10-11	1SFL647025R□□11	
	1650A		GAF1650-10-11	1SFL677025R□□11	
	2050A		GAF2050-10-11	1SFL707025R□□11	

For DC3, DC5 ratings refer technical catalog

## Coil voltages and codes:

### GA 75

Voltage	Voltage	Code
□□□ V - 50Hz	□□□ V - 60Hz	□□
24	24	8 1
110	110 ... 120	8 4
220 ... 230	230 ... 240	8 0
400 ... 415	415 ... 440	8 6

## Coil voltages and codes:

### GAE 75

Voltage	Code
□□□ V d.c.	□□
12	8 0
24	8 2
42	8 1
110	8 6
240	8 9

## Coil voltages and codes:

### GAF range (AC/DC operated)

Voltage	Voltage	Code
V 50/60 Hz	V DC	□□
-	24...60	6 8
48...130	48...130	6 9
100...250	100...250	7 0
250...500	250...500	7 1

## Accessories for contactors



### Auxiliary contact block

Description	Mounting on contactors	Contact configuration		Type code reference	Ordering code	L.P.(₹)			
		NO	NC						
Front mounted single pole add-on blocks	A9...A110 AL9...AL40, TAL9...TAL40 N,NL &UA	1NO	-	CA5-10	1SBN010010R1010 ■	260			
		-	1NC	CA5-01	1SBN010010R1001 ■	260			
		4NO	-	CA5-40 E	1SBN010040R1040				
		3NO	1NC	CA5-31 E	1SBN010040R1031	1,160			
		2NO	2NC	CA5-22 E	1SBN010040R1022 ■				
		4NC	CA5-04 E	1SBN010040R1004					
Side mounted 2 pole add-on blocks	A9...A75, AL9...AL40, TAL9...TAL40, N, NL & UA 16..75	1NO	1NC	CAL5-11	1SBN010020R1011 ■	870			
		A95...A185, UA95...UA110, AF400...AF2050	1NO	1NC	CAL18-11	1SFN010720R1011 ■	990		
			A145...A185	AF400...AF2050	1NO	1NC		CAL18-11B	1SFN010720R3311 ■
			AF205...AF370	1NO	1NC	CAL19-11		1SFN010820R1011 ■	
				1NO	1NC	CAL19-11B		1SFN010820R3311	

### Auxiliary contact blocks for EK range of contactors:

Description	Mounting on contactors	Contact configuration		Type code reference	Ordering code	L.P.(₹)
		NO	NC			
Side mounting Two pole auxiliary contact blocks	EK110 ... EK1000	1NO	1NC	CAL16-11A	SK829002-A ■	990
		1NO	1NC	CAL16-11B	SK829002-B ■	
		1NO	1NC	CAL16-11C	SK829002-C	
		1NO	1NC	CAL16-11D	SK829002-D	

\* Refer technical catalogue for proper selection.

■ Stock items

# Accessories for contactors



## Auxiliary contact block

Description	Mounting on contactors	Contact configuration		Type code reference	Ordering code	L.P. (₹)
		NO	NC			
Front mounted single pole add-on blocks	AX09...AX150, NX 4-pole	1NO	-	CA5X-10	1SBN019010R1010 ■	250
		-	1NC	CA5X-01	1SBN019010R1001 ■	250
Front mounted Four pole add-on blocks	AX09...AX150, NX 4-pole	2NO	2NC	CA5X-22E	1SBN019040R1022 ■	880
		3NO	1NC	CA5X-31E	1SBN019040R1031	
		4NO	-	CA5X-40E	1SBN019040R1040	
		-	4NC	CA5X-04E	1SBN019040R1004	
Side mounted 2 pole add-on blocks	AX09...AX80, NX 4-pole	1NO	1NC	CAL5X-11	1SBN019020R1011 ■	790
		1NO	1NC	CAL18X-11	1SBN019820R1011 ■	800
	AX95...AX205	1NO	1NC	CAL18X-11B	1SBN019820R3311 ■	
		1NO	1NC	CAL19-11	1SBN010820R1011	
	AX260...AX370	1NO	1NC	CAL19-11B	1SBN010820R3311	

## Surge suppressors



For contactor types	Voltage range	Type code reference	Ordering code	L.P. (₹)
AL9...AL40, TAL9...TAL40, NL	12...32 DC	RT5/32	1SBN050020R1000 ■	1,020
	25...65 DC	RT5/65	1SBN050020R1001	
	50...90 DC	RT5/90	1SBN050020R1002	
	77...150 DC	RT5/150	1SBN050020R1003 ■	
	150...264 DC	RT5/264	1SBN050020R1004	
A9...A110, AL9...AL40, TAL9...TAL40, N/NL AX09...AX150	24...50V AC/DC	RV5/50	1SBN050010R1000	1,020
	50...133V AC/DC	RV5/133	1SBN050010R1001	
	110...250V AC/DC	RV5/250	1SBN050010R1002	
	250...440V AC/DC	RV5/440	1SBN050010R1003	
A9...A40, N AX09...AX40	24...50V AC	RC5-1/50	1SBN050100R1000	1,020
	50...133V AC	RC5-1/133	1SBN050100R1001	
	110...250V AC	RC5-1/250	1SBN050100R1002 ■	
	250...440V AC	RC5-1/440	1SBN050100R1003 ■	
A45...A110 AX50...AX150	24...50V AC	RC5-2/50	1SBN050200R1000	1,020
	50...133V AC	RC5-2/133	1SBN050200R1001	
	110...250V AC	RC5-2/250	1SBN050200R1002 ■	
250...440V AC	RC5-2/440	1SBN050200R1003 ■		
A145...A185, AX185...AX205	250...440	RC5-3/440	1SBN050300R1003 ■	2,870
EK550...EK1000	48...110V/AC	RC-EH 800/110	SK829007-C	4,340
	220...600V/AC	RC-EH 800/600	SK829007-D	

# Accessories for contactors



VM5-1



VM300

## Mechanical interlocks

For contactor types	Description	Type code reference	Ordering code	L.P.(₹)
A9...A40, AL9...AL40 AX09...AX40	Horizontal Mechanical Interlock	VM5-1	1SBN030100R1000 ■	680
A9...A40, AL9...AL40 AX09...AX40	Horizontal Mechanical & Electrical Interlock with 2NC contacts	VE5-1	1SBN030110R1000 ■	1,000
A30...A110 AX50...AX115	Horizontal Mechanical & Electrical Interlock with 2NC contacts	VE5-2	1SBN030210R1000 ■	1,950
A95...A185, AX185...AX205	Horizontal with 2NC contacts	VM300H	1SFN034700R1000	4,090
EK110...EK150	Horizontal Mechanical Interlock	VH145	SK829071-A	5,510
EK175...EK210	Horizontal Mechanical Interlock	VH300	SK829071-B	6,390
AF116...AF146 and AF190. AF205	Horizontal Mechanical Interlock	VM140/190	1SFN034403R1000 ■	4,190
AF190, AF205 and AF265 ... AF370	Horizontal Mechanical Interlock	VM205/265	1SFN035203R1000 ■	4,190
AF116...AF370 AX260...AX370	Horizontal Mechanical Interlock	VM19	1SFN030300R1000	4,410

Note: Refer technical catalogue for proper selection.

## Mechanical latching units description

For converting standard contactors into latched contactors. The WB75-A block contains a mechanical latching device with electromagnetic impulse unlatching (AC or DC) or manual unlatching.

## Ordering details



For contactors	Rated control circuit voltage Uc		Type	Ordering code	L.P.(₹)
	V 50 Hz or DC	V 60 Hz			
N, NL, A9-A75	24	24...28	WB75-A	FPTN372726R1001	7,470
	220...230	220...255	WB75-A	FPTN372726R1006	7,470

For contactors	Rated control circuit voltage Uc	Time ranges	Delay type	Auxiliary contacts	Type	Ordering code	L.P.(₹)
----------------	----------------------------------	-------------	------------	--------------------	------	---------------	---------

## Electronic timers

Separate mounting	24-240 V AC 24-48 V DC	0.05s - 100 h	ON-delay	1C/O	CT-ERC.12	1SVR508100R0000	2,890
			ON-delay	2C/O	CT-ERC.22	1SVR508100R0100	5,720
			OFF-delay	1C/O	CT-AHC.12	1SVR508110R0000	3,380
			OFF-delay	2C/O	CT-AHC.22	1SVR508110R0100	6,120



■ Stock items

# Contactors: Wide band AC/DC operated AF technology

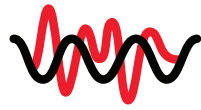

## Conventional AC coil

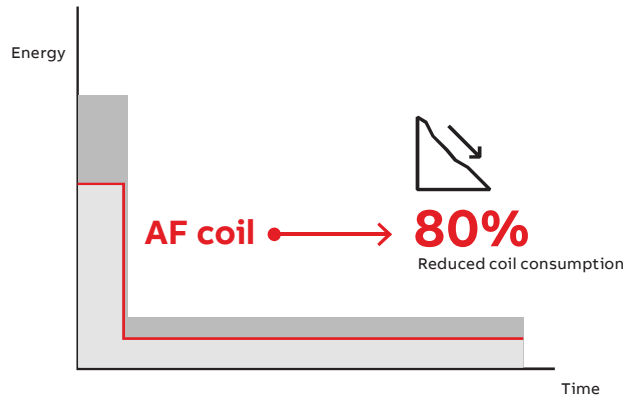

## Reliable in all networks

The electronic system within the AF contactor continuously monitor the current and voltage apply to the coil. The contactor is safely operated in an always optimized condition and hum free.

## Reduced coil consumption

AF coil and energy consumption is reduced up to 80%. This allows a reduction of the temperature rise, the size of control transformers and size of cabinets.

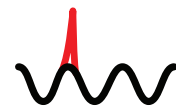
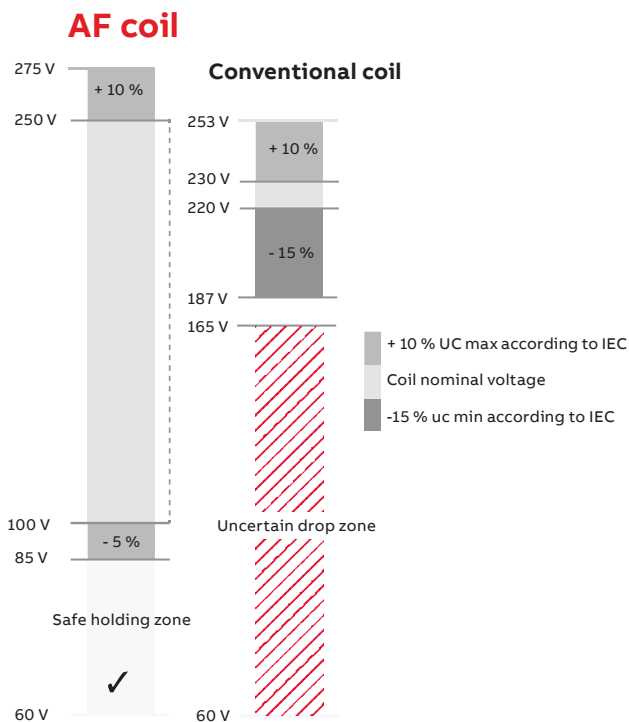

## Wide control voltage range

With conventional contactor technology, different contactors are needed for different network voltages. Thanks to the wide operating range of the AF contactor, it can operate just as well in Europe as in Asia or North America. The core coil of the AF contactor range covers 100-250 V AC / DC, 50 / 60 Hz.

## Built-in surge suppression

With conventional contactor technology, it is recommended to use an external surge suppressor, an accessory that could cost as much as half of the contactor. With the AF technology, the surges are handled by the contactor and never reach the control circuit. One less product and one less complication to worry about.

INTRODUCING **NEW**  
**Novolink™ – smart function and sensor modules**  
**for AF contactors**  
 Integrated into the B&R X20 system

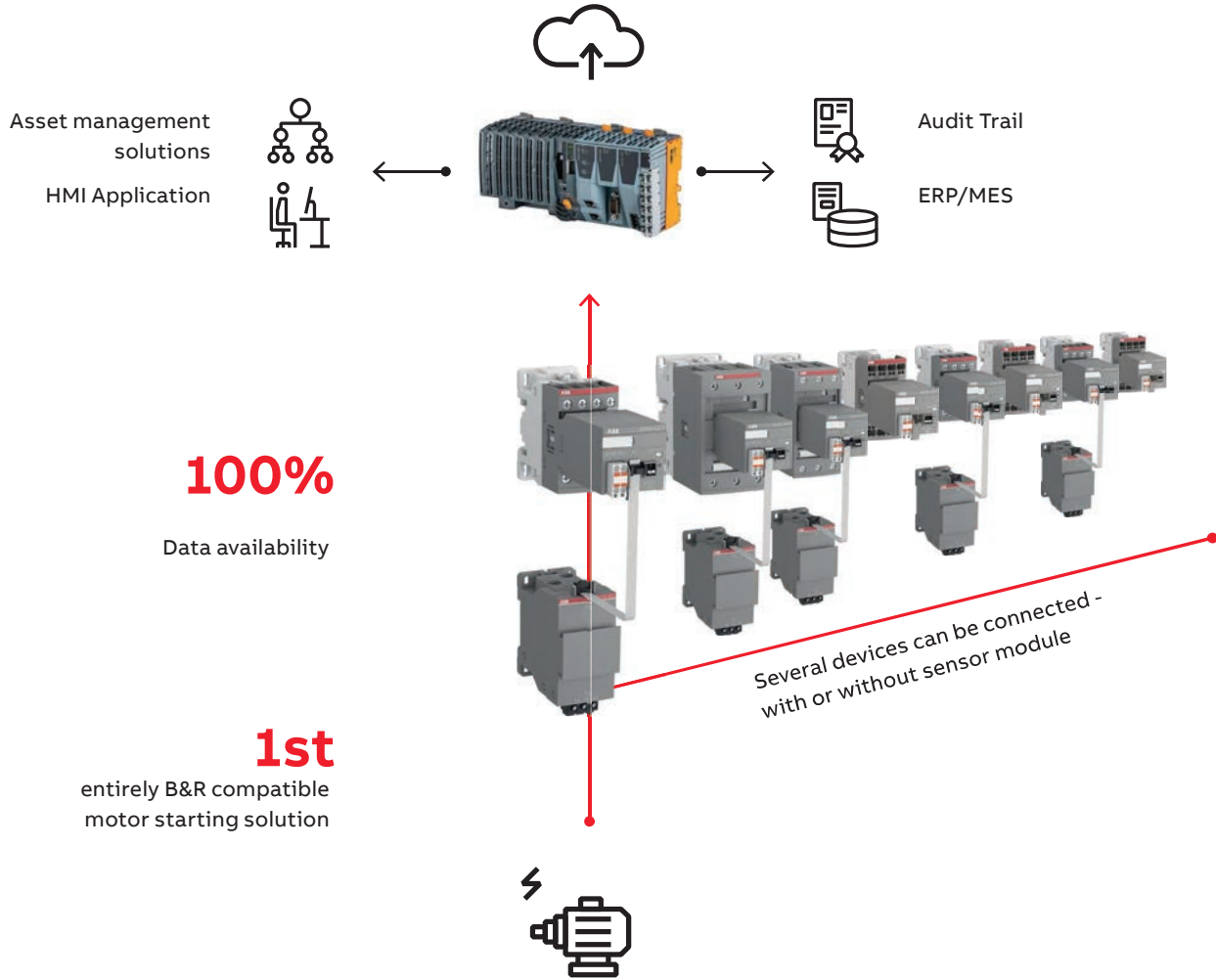

Engineering efficiency - only two configurable components cover a wide range of applications, reducing devices where otherwise auxiliary devices are needed.



Preventive machine maintenance uses live data from relevant motor parameters



Digitalization allows remote contactor control and condition monitoring



Speed of installation  
 Reduction of control side wiring. Integration of multiple functions into one device. Reduction of required PLC I/O signals.

# Digitalize one of the best motor starting portfolios on the market

You have the choice

## Strongest contactor range on the market

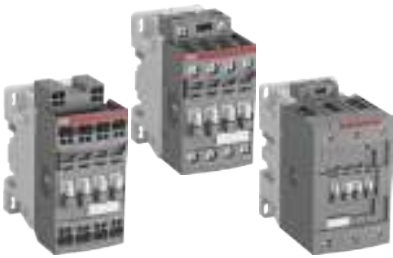

Novolink devices are compatible with 24 V DC coil contactors — from AF09 up to AF96 with screw terminal and AF09 up to AF38 with Push-in Spring terminals

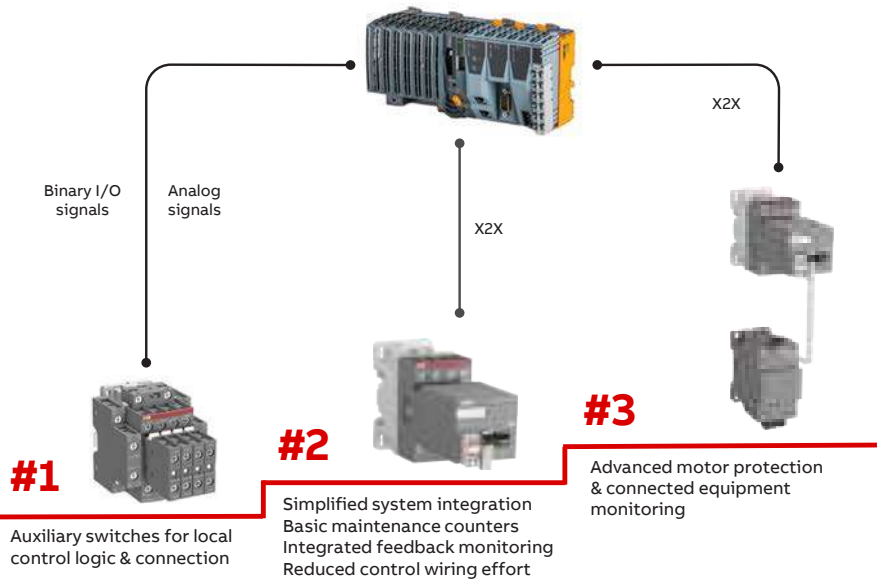

## Ordering details

Type	Description	Order code	L.P.(₹)
SFM-CAB-RJTB.1-500	Connection cable RJ45 - X20 Terminal Block of X20BT9400, 5m	1SVM823000R0500	
SFM-CAB-S.1-50	Connection cable SFM to Sensor 0.5m	1SVM811000R0050	
SFM-CAB-S.1-25	Connection cable SFM to Sensor 0.25m	1SVM811000R0025	Upon request
SCV10-40.1	Current – Voltage Sensor	1SVM320010R0000	
SFM1-A11.1	Advanced Function Module with X2X	1SVM120012R0000	

# 3 pole contactors AF range: Wide band AC/DC operated

## AF contactors are built in with:

- Universal coil operable on wide band AC / DC voltages
- Surge suppressors
- Low power consumption coil



AC1duty Amps	AC3 rating at 415V		Auxiliary contacts	Type code	Ordering code	L.P.(₹)	
	Amps	hP					kW
25	9	5.5	4	1NO -	AF09-30-10-□□	1SBL137001R□□10 ■	3,390
				- 1NC	AF09-30-01-□□	1SBL137001R□□01 ■	3,390
28	12	7.5	5.5	1NO -	AF12-30-10-□□	1SBL157001R□□10 ■	3,750
				- 1NC	AF12-30-01-□□	1SBL157001R□□01 ■	3,750
30	18	12.5	7.5	1NO -	AF16-30-10-□□	1SBL177001R□□10 ■	4,580
				- 1NC	AF16-30-01-□□	1SBL177001R□□01 ■	4,580
45	26	15	11	- -	AF26-30-00-□□	1SBL237001R□□00 ■	5,720
50	32	20	18	- -	AF30-30-00-□□	1SBL277001R□□00 ■	12,430
50	38	25	18.5	- -	AF38-30-00-□□	1SBL297001R□□00 ■	14,380
70	40	30	18.5	- -	AF40-30-00-□□	1SBL347001R□□00 ■	15,580
100	53	40	22	- -	AF52-30-00-□□	1SBL367001R□□00 ■	17,540
105	65	50	30	- -	AF65-30-00-□□	1SBL387001R□□00 ■	20,510
125	80	60	37	- -	AF80-30-00-□□	1SBL397001R□□00 ■	24,460
130	96	70	45	- -	AF96-30-00-□□	1SBL407001R□□00 ■	29,400
160	116	75	55	1NO 1NC	AF116-30-11-□□	1SFL427001R□□11 ■	37,100
200	140	100	75	1NO 1NC	AF140-30-11-□□	1SFL447001R□□11 ■	40,910
225	146	100	75	1NO 1NC	AF146-30-11-□□	1SFL467001R□□11 ■	42,880
275	190	120	90	1NO 1NC	AF190-30-11-□□	1SFL487002R□□11 ■	51,720
350	205	150	110	1NO 1NC	AF205-30-11-□□	1SFL527002R□□11 ■	54,890
400	265	175	140	1NO 1NC	AF265-30-11-□□	1SFL547002R□□11 ■	65,840
500	305	215	160	1NO 1NC	AF305-30-11-□□	1SFL587002R□□11 ■	77,840
600	370	270	200	1NO 1NC	AF370-30-11-□□	1SFL607002R□□11 ■	1,01,270
600	400	300	220	1NO 1NC	AF400-30-11**	1SFL577001R□□11 ■	1,02,080
700	460	340	250	1NO 1NC	AF460-30-11**	1SFL597001R□□11 ■	1,36,330
800	580	470	355	1NO 1NC	AF580-30-11**	1SFL617001R□□11 ■	2,13,180
1050	750	570	425	1NO 1NC	AF750-30-11**	1SFL637001R□□11 ■	
1260	-	-	-	1NO 1NC	AF1250-30-11**	1SFL647001R□□11 ■	
1350	860	-	500	1NO 1NC	AF1350-30-11**	1SFL657001R□□11 ■	
1650	1050	-	600	1NO 1NC	AF1650-30-11**	1SFL677001R□□11 ■	
2050	-	-	-	1NO 1NC	AF2050-30-11**	1SFL707001R□□11 ■	
2650	-	-	-	1NO 1NC	AF2650-30-11**	1SFL667001R□□11 ■	
2850	-	-	-	1NO 1NC	AF2850-30-11**	1SFL687001R□□11 ■	

Upon request

Complete the contactor type code by replacing \*\* with desired coil voltage, AF contactors have advanced electronic coil interface with wideband AC/DC coil

## Coil voltages and codes:

### New AF09...AF370 range (AC/DC operated)

Voltage	Voltage	Code
V 50/60 Hz	V DC	□□
24...60	20...60	1 1 ■
48...130	48...130	1 2 ■
100...250	100...250	1 3 ■
250...500	250...500	1 4 ■

### AF400...AF1250 range (AC/DC operated)

Voltage	Voltage	Code
V 50/60 Hz	V DC	□□
-	24...60	6 8
48...130	48...130	6 9
100...250	100...250	7 0 ■
250...500	250...500	7 1 ■

### AF1350...AF2850 range (AC/DC operated)

Voltage	Voltage	Code
V 50/60 Hz	DC	□□
100...250	100...250	7 0
		7 0

Note: For non-standard coil voltage, other than this contact us for price.  
Refer Page 82 and Page 83 for accessories

■ Stock items



## 4 pole contactors: Wide band AC/DC operated

### New AF Contactors: 4 pole – AC / DC Operated

Rating at 415V AC1 Amps	Main contact arrangement	Auxiliary contacts			Type code reference	Ordering code	L.P.(₹)
25	4NO	-	-	-	AF09-40-00-□□	1SBL137201R□□00 ■	3,430
	2NO	2NC	-	-	AF09-22-00-□□	1SBL137501R□□00	4,290
30	4NO	-	-	-	AF16-40-00-□□	1SBL177201R□□00	4,380
	2NO	2NC	-	-	AF16-22-00-□□	1SBL177501R□□00 ■	5,250
45	4NO	-	-	-	AF26-40-00-□□	1SBL237201R□□00	6,510
	2NO	2NC	-	-	AF26-22-00-□□	1SBL237501R□□00	8,050
55	4NO	-	-	-	AF38-40-00-□□	1SBL297201R□□00 ■	13,340
	2NO	2NC	-	-	AF38-22-00-□□	1SBL297501R□□00	16,220
70	4NO	-	-	-	AF40-40-00-□□	1SBL347201R□□00	21,120
	2NO	2NC	-	-	AF40-22-00-□□	1SBL347501R□□00	23,370
100	4NO	-	-	-	AF52-40-00-□□	1SBL367201R□□00 ■	21,970
125	4NO	-	-	-	AF80-40-00-□□	1SBL397201R□□00	26,690
	2NO	2NC	-	-	AF80-22-00-□□	1SBL397501R□□00	29,920
160	4NO	-	-	-	AF116-40-00-□□	1SFL427102R□□00 ■	37,670
200	4NO	-	-	-	AF140-40-00-□□	1SFL447102R□□00 ■	42,770
275	4NO	-	-	-	AF190-40-00-□□	1SFL487102R□□00 ■	58,360
350	4NO	-	-	-	AF205-40-00-□□	1SFL527102R□□00 ■	69,590
400	4NO	-	-	-	AF265-40-00-□□	1SFL547102R□□00 ■	83,460
500	4NO	-	-	-	AF305-40-00-□□	1SFL587102R□□00 ■	1,05,680
525	4NO	-	-	-	AF370-40-00-□□	1SFL607102R□□00 ■	1,17,900

### Coil voltages and codes: New AF range (AC/DC operated)

Voltage	Voltage	Code
V 50/60 Hz	V DC	□□
24...60	20...60	1 1 ■
48...130	48...130	1 2 ■
100...250	100...250	1 3 ■
250...500	250...500	1 4 ■

■ Stock items

# Accessories for AF contactors

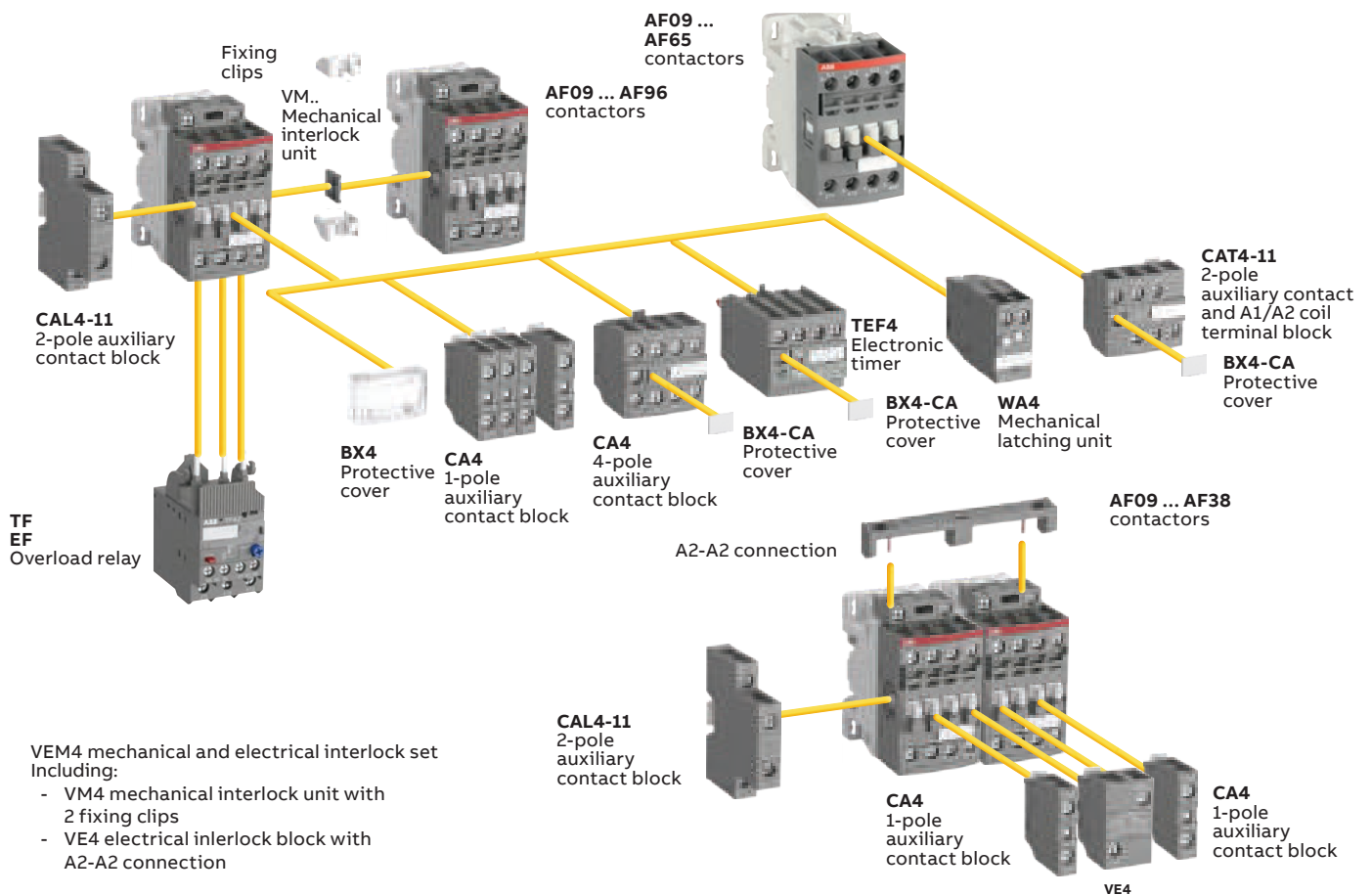

# Accessories for AF contactors

## Auxiliary contact block

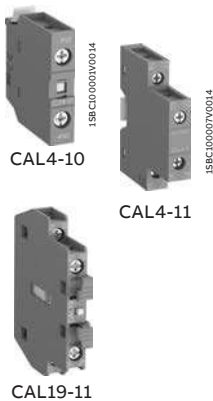

Description	Mounting on contactors	Contact configuration		Type code reference	Ordering code	L.P.(₹)
		NO	NC			
Front mounted 1 pole add-on blocks	AF09....AF96 / NF	1NO	-	CA4-10	1SBN010110R1010 ■	280
		-	1NC	CA4-01	1SBN010110R1001 ■	280
Front mounted 4 pole add-on blocks	AF09....AF80 / NF	4NO	-	CA4-40E	1SBN010140R1040 ■	1,160
		3NO	1NC	CA4-31E	1SBN010140R1031	1,160
		2NO	2NC	CA4-22E	1SBN010140R1022 ■	1,160
		-	4NC	CA4-04E	1SBN010140R1004	1,160
Side mounted 2 pole add-on blocks	AF09....AF96 / NF	1NO	1NC	CAL4-11	1SBN010120R1011 ■	750
	AF96...AF370	1NO	1NC	CAL19-11	1SFN010820R1011 ■	1,000
		1NO	1NC	CAL19-11B	1SFN010820R3311 ■	

\* Refer technical catalogue for proper selection.

# Accessories for AF contactors



## Mechanical interlocks

Description	For contactor types	Type Code reference	Ordering code	L.P.(₹)
Horizontal Mechanical Interlock	AF09...AF38	VM4	1SBN030105T1000	800
Horizontal Mechanical & Electrical Interlock	AF09...AF38	VEM4	1SBN030111R1000	1,430
Horizontal Mechanical Interlock	AF40...AF96	VM96-4	1SBN033405T1000	2,910
Horizontal Mechanical Interlock	AF116...AF146 and AF190, AF205	VM140/190	1SFN034403R1000	4,210
Horizontal Mechanical Interlock	AF190, AF205 and AF265 ... AF370	VM205/265	1SFN034403R1000	4,210
Horizontal Mechanical Interlock	AF116...AF370	VM19	1SFN030300R1000	4,350

Note: Refer technical catalogue for proper selection.

## Ordering details



For contactors	Rated control circuit voltage Uc	Type	Ordering code	L.P.(₹)
NF(Z),AF(Z)09....38,AF40...65	24V DC	WA4-10	1SBN040100R1010	3,210
NF(Z),AF(Z)09....38,AF40...65	24-60V50/60HZ-DC	WA4-11	1SBN040100R1011	3,210
NF(Z),AF(Z)09....38,AF40...65	48-130V50/60HZ-DC	WA4-12	1SBN040100R1012	3,210
NF(Z),AF(Z)09....38,AF40...65	100-250V50/60HZ-DC	WA4-13	1SBN040100R1013	3,210
NF(Z),AF(Z)09....38,AF40...65	250-500V50/60HZ-DC	WA4-14	1SBN040100R1014	3,210
AF80....96	24-60V50/60HZ-DC	WA4-96-11	1SBN040200R1011	3,210
AF80....96	48-130V50/60HZ-DC	WA4-96-12	1SBN040200R1012	3,210
AF80....96	100-250V50/60HZ-DC	WA4-96-13	1SBN040200R1013	3,210
AF80....96	250-500V50/60HZ-DC	WA4-96-14	1SBN040200R1014	3,210

## Electronic timers

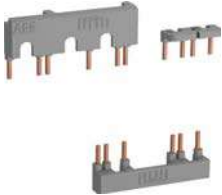

For contactor types	Time delay range selected by switch	Delay type	Auxiliary contacts	Type	Ordering code	L.P.(₹)
AF09 ... AF96	0.1...1 s 1...10 s 10...100 s	ON-delay	1NO + 1NC	TEF4-ON	1SBN020112R1000	7,770
		OFF-delay	1NO + 1NC	TEF4-OFF	1SBN020114R1000	7,390

Note: Rated control circuit voltage Uc 24...240 V 50/60 Hz or DC.

## Connecting links with manual motor starters

For contactor types	Used with	Type	Ordering code	L.P.(₹)
AF09 ... AF16	MS116-0.16 ... MS116-25, MS132-0.16 ... MS132-25	BEA16-4	1SBN081306T1000	570
AF26 ... AF30	MS116-0.16 ... MS116-16, MS132-0.16 ... MS132-10	BEA26-4	1SBN082306T1000	640
	MS116-20 ... MS116-32, MS132-12 ... MS132-32	BEA38-4	1SBN082306T2000	700

## Connection sets for reversing contactors

For contactor types	Type	Ordering code	L.P.(₹)
AF09 ... AF16	BER16-4	1SBN081311R1000	1,420
AF26 ... AF30	BER38-4	1SBN082311R1000	1,910
AF40 ... AF65	BER65-4	1SBN083411R1000	2,290
AF80 ... AF96	BER96-4	1SBN083911R1000	3,980

## Connection sets for star-delta starting

For contactor types	Type	Ordering code	L.P.(₹)
AF09 ... AF16	BEY16-4	1SBN081313R2000	1,940
AF26 ... AF30	BEY38-4	1SBN082713R2000	2,970
AF40 ... AF65	BEY65-4	1SBN083413R2000	3,850
AF80 ... AF96	BEY96-4	1SBN083913R2000	4,930

# AFC contactors for AC control applications NEW

## Flexible and safe

### Part of the AF platform

AFC contactors are an extension of the AF platform. Sharing same footprint and having equivalent electrical performance, installation design and maintenance are easier and faster. Protection devices (manual motor starters, overloads relays), accessories (auxiliary contacts, electronic timers, ...) and connection kits (direct-on-line, reversing, start delta) are common to the entire platform.



### Great flexibility for coil terminal access and surge suppressor

AFC contactors offer free choice of coil terminal access from top, bottom or front. Surge suppressor can be mounted from top or bottom.

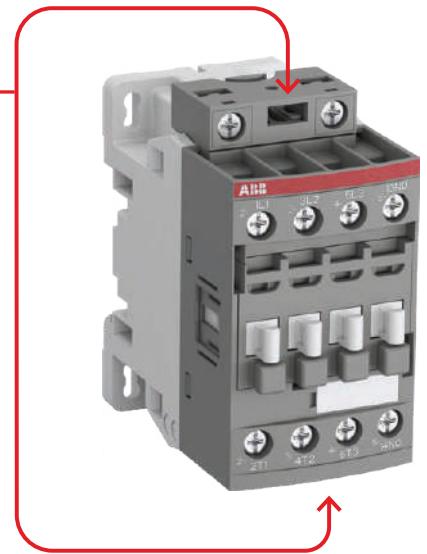

### Compatible and easy to use accessories

1-pole, 2-pole and 4-pole auxiliary contact blocks (front or side mounted) are available with screw and Push-in Spring terminals: They can be mounted on every contactor of the AF platform, whatever its terminal connection type.



### Easy, fast and secure starters assembly

The AF contactor range is perfect for motor starting applications and for solutions where space is limited. You can create any motor starting type and save assembly time with a complete range of accessories and connection sets.



### Protect from overload in all conditions

Select thermal overload relays (trip class 10) or electronic overload relays (trip class 10E, 20E, 30E in the same product) to protect your motors against overload and phase failure.

# AFC contactors: AC operated NEW



## Contactors: 3-pole – AC operated

AC1 duty Amps	AC3 rating at 415V			Auxiliary contacts		Type code	Ordering code	L.P.(₹)
	Amps	hP	kW					
25	9	5.5	4	1NO	-	AFC09-30-10 **	1SBL131001R□□10 ■	Upon request
25	9	5.5	4	-	1NC	AFC09-30-01 **	1SBL131001R□□01 ■	
28	12	7.5	5.5	1NO	-	AFC12-30-10 **	1SBL151001R□□10 ■	
28	12	7.5	5.5	-	1NC	AFC12-30-01 **	1SBL151001R□□01 ■	
30	17	12.5	7.5	1NO	-	AFC16-30-10 **	1SBL171001R□□10 ■	
30	17	12.5	7.5	-	1NC	AFC16-30-01 **	1SBL171001R□□01 ■	
45	26	15	11	-	-	AFC26-30-00 **	1SBL231001R□□00 ■	
50	32	20	15	-	-	AFC30-30-00 **	1SBL271001R□□00 ■	
50	37	30	18.5	-	-	AFC40-30-00 **	1SBL291001R□□00 ■	

## Contactors: 4-pole (AC operated)

Rating at 415V AC1 Amps	Main contact arrangement		Auxiliary contacts		Type code reference	Ordering code	L.P.(₹)
25	4NO	-	-	-	AFC09-40-00 **	1SBL131201R□□00 ■	Upon request
25	2NO	2NC	-	-	AFC09-22-00 **	1SBL131501R□□00 ■	
30	4NO	-	-	-	AFC16-40-00 **	1SBL171201R□□00 ■	
30	2NO	2NC	-	-	AFC16-22-00 **	1SBL171501R□□00 ■	
45	4NO	-	-	-	AFC26-40-00 **	1SBL231201R□□00 ■	
45	2NO	2NC	-	-	AFC26-22-00 **	1SBL231501R□□00 ■	
55	4NO	-	-	-	AFC38-40-00**	1SBL291201R□□00 ■	
55	2NO	2NC	-	-	AFC38-22-00**	1SBL291501R□□00 ■	

## Auxiliary contactors

No. of contacts	Contact configuration		Type code reference	Ordering code	L.P.(₹)
	NO	NC			
4	2	2	NFC22E **	1SBH131001R□□22 ■	Upon request
4	3	1	NFC31E **	1SBH131001R□□31 ■	
4	4	0	NFC40E **	1SBH131001R□□40 ■	
8	4	4	NFC44E **	1SBH131001R□□44 ■	
8	5	3	NFC53E **	1SBH131001R□□53 ■	
8	6	2	NFC62E **	1SBH131001R□□62 ■	
8	7	1	NFC71E **	1SBH131001R□□71 ■	
8	8	0	NFC80E **	1SBH131001R□□80 ■	

## Coil voltages and codes:

### AFC09 ... AFC38/NFC range

Voltage	Voltage	Code
□□ V - 50Hz	□□ V - 60Hz	□□
24	24	8 1 ■
110	110 ... 120	8 4 ■
220 ... 230	230 ... 240	8 0 ■
400 ... 415	415 ... 440	8 6 ■

Note: For non-standard coil voltage, other than this contact us for price.



# Powerful light switching made easy

## ESB and EN installation contactors



ABB's hum-free installation contactor designs offer a wide range of ratings from 16 A to 100 A. With an innovative AC/DC coil design that eliminates hum, a broad selection of common accessories as well as manual and automatic versions, ESB..N contactors cover all your needs in both domestic and residential applications. Find out more at [abb.com/lowvoltage](http://abb.com/lowvoltage)



# ESB and EN Installation contactors



Hum-free operation



Tool-free to save time



More choice,  
less inventory



Comprehensive solution



Optimum interface



Easy to install



Group mounting  
saves space



Global  
availability



Easy identification

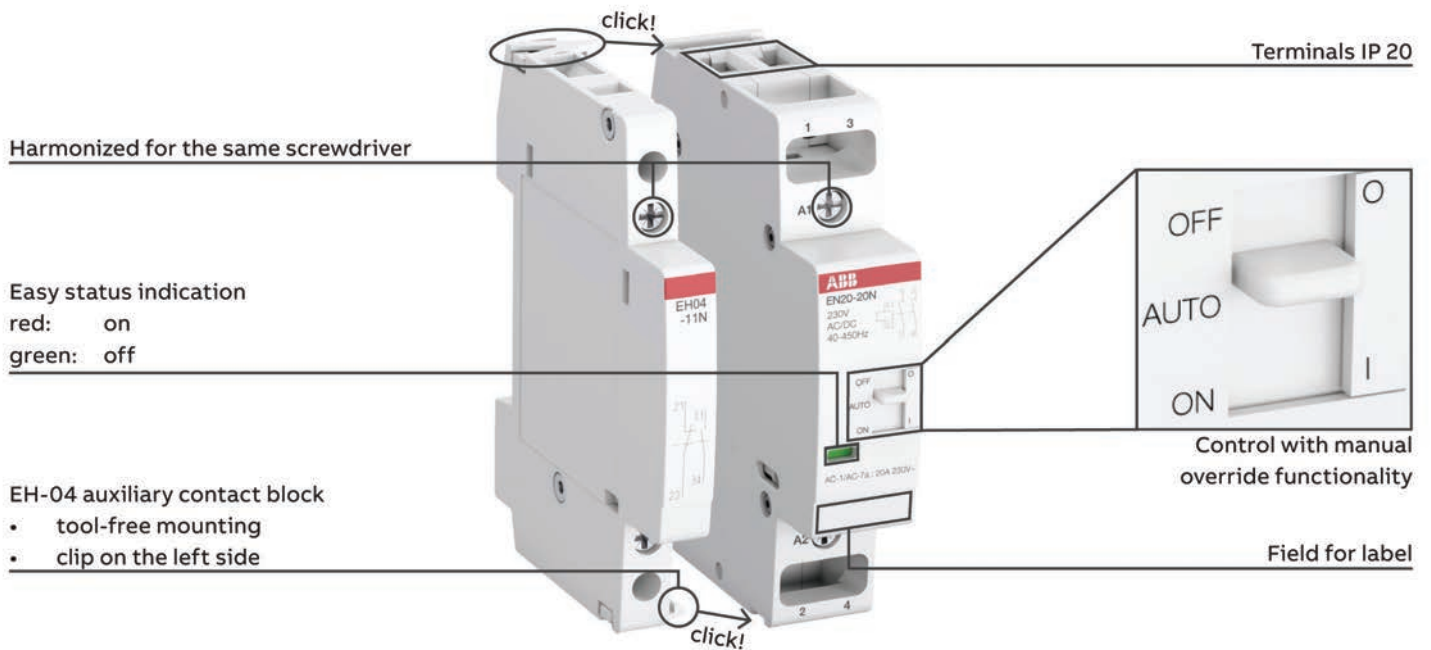

Harmonized for the same screwdriver

Easy status indication

red: on  
green: off

EH-04 auxiliary contact block







- tool-free mounting
- clip on the left side







Control with manual  
override functionality











Field for label











# ESB and EN Installation contactors







ABB's installation contactor range comes with a host of features to make installation and maintenance easier. A mechanical indicator shows the status in green or red color to make system diagnostics quicker. Some speciality types also feature a manual override functionality with a toggle switch providing independent control. Accessories such as auxiliaries, space holders, as well as safety covers can be mounted tool-free onto the contactor.





Main contacts	Width in number of modular spacings	Rated control circuit voltage <sup>(1)</sup> V AC / DC	Type	Ordering code	L.P. (₹)
	1	24	ESB16-20N-01	1SBE11111R0120	3,370
	1	230	ESB16-20N-06	1SBE11111R0620	3,370
	1	24	ESB16-02N-01	1SBE11111R0102	3,530
	1	230	ESB16-02N-06	1SBE11111R0602	3,530
	1	24	ESB16-11N-01	1SBE11111R0111	3,430
	1	230	ESB16-11N-06	1SBE11111R0611	3,430

Main contacts	Width in number of modular spacings	Rated control circuit voltage <sup>(1)</sup> V AC / DC	Type	Ordering code	L.P. (₹)
	1	24	ESB20-20N-01	1SBE12111R0120	3,740
	1	230	ESB20-20N-06	1SBE12111R0620	3,740
	1	24	ESB20-02N-01	1SBE12111R0102	3,900
	1	230	ESB20-02N-06	1SBE12111R0602	3,900
	1	24	ESB20-11N-01	1SBE12111R0111	3,770
	1	230	ESB20-11N-06	1SBE12111R0611	3,770

Main contacts	Width in number of modular spacings	Rated control circuit voltage <sup>(1)</sup> V AC / DC	Type	Ordering code	L.P. (₹)
	2	24	ESB25-40N-01	1SAE23111R0140	3,800
	2	230 ... 240	ESB25-40N-06	1SAE23111R0640	3,800
	2	24	ESB25-04N-01	1SAE23111R0104	3,940
	2	230 ... 240	ESB25-04N-06	1SAE23111R0604	3,940
	2	24	ESB25-22N-01	1SAE23111R0122	3,940
	2	230 ... 240	ESB25-22N-06	1SAE23111R0622	3,940
	2	24	ESB25-31N-01	1SAE23111R0131	3,940
	2	230 ... 240	ESB25-31N-06	1SAE23111R0631	3,940
	2	24	ESB25-13N-01	1SAE23111R0113	3,940
	2	230 ... 240	ESB25-13N-06	1SAE23111R0613	3,940

Main contacts	Width in number of modular spacings	Rated control circuit voltage <sup>(1)</sup> V AC / DC	Type	Ordering code	L.P. (₹)
	3	24	ESB40-40N-01	1SAE34111R0140	7,010
	3	230	ESB40-40N-06	1SAE34111R0640	7,010
	3	24	ESB40-22N-01	1SAE34111R0122	7,120
	3	230	ESB40-22N-06	1SAE34111R0622	7,120
	3	24	ESB40-31N-01	1SAE34111R0131	7,120
	3	230	ESB40-31N-06	1SAE34111R0631	7,120
	3	24	ESB40-30N-01	1SAE34111R0130	6,740
	3	230	ESB40-30N-06	1SAE34111R0630	6,740
	3	24	ESB40-20N-01	1SAE34111R0120	6,740
	3	230	ESB40-20N-06	1SAE34111R0620	6,500



Main contacts	Width in number of modular spacings	Rated control circuit voltage <sup>(1)</sup> V AC / DC	Type	Ordering code	L.P. (₹)
	3	24	ESB63-40N-01	1SAE35111R0140	9,120
	3	230	ESB63-40N-06	1SAE35111R0640	9,120
	3	230	ESB63-31N-06	1SAE35111R0631	9,380
	3	230	ESB63-30N-06	1SAE35111R0630	8,880
	3	24	ESB63-20N-01	1SAE35111R0120	8,740
	3	230	ESB63-20N-06	1SAE35111R0620	8,740





Main contacts	Width in number of modular spacings	Rated control circuit voltage <sup>(1)</sup> V AC / DC	Type	Ordering code	L.P. (₹)
	6	24	ESB100-40N-01	1SAE66111R0140	31,210
	6	230	ESB100-40N-06	1SAE66111R0640	31,210
	3	24	ESB100-20N-01	1SAE36111R0120	29,880
	3	230	ESB100-20N-06	1SAE36111R0620	29,880



# ESB and EN Installation contactors

Main contacts	Width in number of modular spacings	Rated control circuit voltage <sup>(1)</sup> V AC / DC	Type	Ordering code	L.P. (₹)
	1	24	EN20-20N-01	1SBE122111R0120	5,250
		230	EN20-20N-06	1SBE122111R0620	

Main contacts	Width in number of modular spacings	Rated control circuit voltage <sup>(1)</sup> V AC / DC	Type	Ordering code	L.P. (₹)
	2	24	EN25-40N-01	1SAE232111R0140	15,690
		230 ... 240	EN25-40N-06	1SAE232111R0640	16,010
	2	24	EN25-31N-01	1SAE232111R0131	16,120
		230 ... 240	EN25-31N-06	1SAE232111R0631	16,120
	2	230 ... 240	EN25-30N-06	1SAE232111R0630	14,000

Main contacts	Width in number of modular spacings	Rated control circuit voltage <sup>(1)</sup> V AC / DC	Type	Ordering code	L.P. (₹)
	3	24	EN40-40N-01	1SAE342111R0140	16,070
		230	EN40-40N-06	1SAE342111R0640	16,070
	3	24	EN40-31N-01	1SAE342111R0131	16,200
		230	EN40-31N-06	1SAE342111R0631	16,200
	3	230	EN40-30N-06	1SAE342111R0630	14,380
	3	230	EN40-20N-06	1SAE342111R0620	14,000

## Auxiliary contact blocks

Auxiliary contacts	Suitable for	Type	Ordering code	L.P. (₹)
<b>Single packaging</b>				
	ESB16..N, ESB20..N, ESB25..N, ESB40..N, ESB63..N, ESB100..N, EN20..N, EN25..N, EN40..N	EH04-11N	1SAE901901R1011	1,230
		EH04-20N	1SAE901901R1020	1,230

## Distant piece

Suitable for	Type	Ordering code	L.P. (₹)
<b>Single packaging</b>			
ESB25..N, ESB40..N, ESB63..N, EN25..N, EN40..N, ESB100..N, EN100..N	ESB-DIS	GHE3201902R0001	230

# Mini contactors



## Mini contactors with screw connection: 3 pole - AC operated

AC1 duty Amps	AC3 rating at 415V			Auxiliary contacts		Type code reference	Ordering code	L.P.(₹)
	Amps	hP	kW					
16A	9	5.5	4	1NO	-	B06-30-10 **	GJL1211001R□10□ ■	1,500
16A	9	5.5	4	-	1NC	B06-30-01 **	GJL1211001R□01□ ■	
20A	12	7.5	5.5	1NO	-	B07-30-10 **	GJL1311001R□10□ ■	1,640
20A	12	7.5	5.5	-	1NC	B07-30-01 **	GJL1311001R□01□ ■	

## 3 pole - DC operated

Type code reference	Ordering code	L.P.(₹)
BC6-30-10 **	GJL1213001R□10□ ■	2,070
BC6-30-01 **	GJL1213001R□01□ ■	
BC7-30-10 **	GJL1313001R□10□ ■	2,250
BC7-30-01 **	GJL1313001R□01□ ■	

Complete the contactor type code by replacing \*\* with desired coil voltage

## Mini reversing contactors with screw connection:

### 3 pole - AC operated

AC1 duty Amps	AC3 rating at 415V			Auxiliary contacts		Type code reference	Ordering code	L.P.(₹)
	Amps	hP	kW					
16A	9	5.5	4	1NO	-	VB06-30-10 **	GJL1211901R□10□ □	4,400
16A	9	5.5	4	-	1NC	VB06-30-01 **	GJL1211901R□01□ □	4,400
20A	12	7.5	5.5	1NO	-	VB07-30-10 **	GJL1311901R□10□ □	4,640
20A	12	7.5	5.5	-	1NC	VB07-30-01 **	GJL1311901R□01□ □	4,640

### 3 pole - DC operated

Type code reference	Ordering code	L.P.(₹)
VBC6-30-10 **	GJL1213901R□10□ □	4,590
VBC6-30-01 **	GJL1213901R□01□ ■	4,590
VBC7-30-10 **	GJL1313901R□10□ □	4,920
VBC7-30-01 **	GJL1313901R□01□ □	4,920

Complete the contactor type code by replacing \*\* with desired coil voltage

Mini contactors are also available in 4 pole (4NO / 2NO + 2NC)

## Mini auxiliary contactor 4 pole with screw connection

Control circuit	Contact configuration		Type code reference	Ordering code	L.P.(₹)
	NO	NC			
AC	2NO	2NC	K6-22Z**	GJH1211001R□22□ □	1,650
	3NO	1NC	K6-31Z **	GJH1211001R□31□ ■	
	4NO	-	K6-40E **	GJH1211001R□40□ □	
DC	2NO	2NC	KC6-22Z**	GJH1213001R□22□ ■	2,120
	3NO	1NC	KC6-31Z **	GJH1213001R□31□ □	
	4NO	-	KC6-40E **	GJH1213001R□40□ □	

## Coil voltage for mini contactors

AC		DC	
50-60Hz	Code	DC V	Code
24	0 ... 1 ■	24	0 ... 1 ■
48	0 ... 3	110 ... 125	0 ... 4 ■
110 ... 127	8 ... 4 ■	220 ... 240	0 ... 5
220 ... 240	8 ... 0 ■		
380 ... 415	8 ... 5		

Complete the contactor type code by replacing \*\* with desired coil voltage

## Auxiliary contact blocks for mini contactors

### Ordering details

For contactor types	Auxiliary contacts	Type	Ordering code	L.P.(₹)
<b>Front mounted instantaneous auxiliary contact blocks</b>				
B6-, B7-30-10, BC6-, BC7-30-10	1NO + 1NC	CAF6-11M	GJL1201330R0003	880
VB6, VB7, VBC6, VBC7, VB6A, VB7A	2NO	CAF6-20M	GJL1201330R0007	
VBC6A, VBC7A	2NC	CAF6-02M	GJL1201330R0011	
<b>Side mounted instantaneous auxiliary contact block</b>				
B6-, B7-30-10, BC6-, BC7-30-10	1NO + 1NC	CA6-11M	GJL1201317R0003	880

■ Stock items

# DOL and star delta starters



## Direct on line starter:

Rating at 415V 50Hz		Back - up Fuse rating (A)	Type code reference	Ordering code	L.P.(₹)
HP	kW				
0.25	0.18	4A	MA-0.25 **	1SYN140318R□□25	4,020
0.50	0.37	4A	MA-0.50 **	1SYN140318R□□05	4,020
0.75	0.52	6A	MA-0.75 **	1SYN140318R□□75	4,020
1.00	0.75	6A	MA-1.00 **	1SYN140318R□□10 ■	4,020
1.50	1.10	10A	MA-1.50 **	1SYN140318R□□15	4,020
2.00	1.50	10A	MA-2.00 **	1SYN140318R□□20 ■	4,020
3.00	2.20	16A	MA-3.00 **	1SYN140318R□□30 ■	4,020
5.00	3.70	25A	MA-5.00 **	1SYN140318R□□50 ■	4,020
7.50	5.50	32A	MA-7.50 **	1SYN16018R□□75 ■	4,020
10.00	7.50	32A	MA-10.00 **	1SYN180318R□□10 ■	4,350



## Fully automatic Star Delta starter:

Rating at 415V 50Hz		Type code reference	Ordering code	L.P.(₹)
HP	kW			
12.5	12.5/9.3	SDA-12.5 **	1SYN184322R□□00 ■	15,590
15	15/11	SDA-15 **	1SYN242322R□□00 ■	16,960
20	20/15	SDA- 20 **	1SYN244322R□□00 ■	19,670
25	25/18.5	SDA-25 **	1SYN246322R□□00	20,490
30	30/22	SDA-30 **	1SYN282322R□□00	24,750
35	35/26	SDA-35 **	1SYN284322R□□00	27,460
40	40/30	SDA-40 **	1SYN322322R□□00	33,320
50	50/37	SDA-50 **	1SYN352342R□□00	40,390
60	60/45	SDA-60 **	1SYN372342R□□00	51,950
75	75/55	SDA-75 **	1SYN412342R□□00	60,890

Complete the starter type code by replacing the \*\* with the desired coil voltage.

Voltage	Code
	□□
220 ... 230 V coil	3 8
400 ... 415 V coil	8 6 ■

## DOL Starter with IP65 enclosure



## 4KE 7.5KW 415V, IP65 compact plastic enclosure with double insulation



Description	Ordering code	L.P.(₹)
DRAS09-29P 4.0 kW 415V, 415V coil	1SBK104035R2900	8,200
DRAS12-29P 5.5 kW 415V, 415V coil	1SBK114035R2900	8,820
DRAS16-29P 7.5 kW 415V, 415V coil	1SBK124035R2900	11,850

Note: T16 OLR to be ordered separately. Plz refer page no. 120 for reference.

# Manual motor starter

With thermal and electromagnetic protection



## MS116 Manual motor starters with short circuit, overload and phase loss protection

Rated power 415V KW	Ie current setting range Amp	S/C Icu breaking capacity kA	Type	Ordering code	L.P. (₹)
0.03	0.10 ... 0.16	50	MS116-0.16	1SAM250000R1001 ■	4,050
0.06	0.16 ... 0.25	50	MS116-0.25	1SAM250000R1002 ■	4,050
0.09	0.25 ... 0.40	50	MS116-0.4	1SAM250000R1003 ■	4,050
0.12	0.40 ... 0.63	50	MS116-0.63	1SAM250000R1004 ■	4,620
0.25	0.63 ... 1.00	50	MS116-1.0	1SAM250000R1005 ■	4,620
0.55	1.00 ... 1.60	50	MS116-1.6	1SAM250000R1006 ■	4,630
0.75	1.60 ... 2.50	50	MS116-2.5	1SAM250000R1007 ■	4,630
1.5	2.50 ... 4.00	50	MS116-4.0	1SAM250000R1008 ■	4,720
2.2	4.00 ... 6.30	50	MS116-6.3	1SAM250000R1009 ■	4,720
4.0	6.30 ... 10.0	50	MS116-10	1SAM250000R1010 ■	4,950
5.5	8.00 ... 12.0	25	MS116-12	1SAM250000R1012 ■	5,630
7.5	10.0 ... 16.0	16	MS116-16	1SAM250000R1011 ■	6,020
9.0	16.0 ... 20.0	15	MS116-20	1SAM250000R1013 ■	6,530
12.5	20.0 ... 25.0	15	MS116-25	1SAM250000R1014 ■	6,980
15.5	25.0 ... 32.0	10	MS116-32	1SAM250000R1015 ■	12,980



## MS132 Manual motor starters with short circuit, overload and phase loss protection

Rated power 415V KW	Ie current setting range Amp	S/C Icu breaking capacity kA	Type	Ordering code	L.P. (₹)
0.03	0.10 ... 0.16	100	MS132-0.16	1SAM350000R1001	5,310
0.06	0.16 ... 0.25	100	MS132-0.25	1SAM350000R1002 ■	5,310
0.09	0.25 ... 0.40	100	MS132-0.4	1SAM350000R1003 ■	5,310
0.12	0.40 ... 0.63	100	MS132-0.63	1SAM350000R1004 ■	5,850
0.25	0.63 ... 1.00	100	MS132-1.0	1SAM350000R1005 ■	5,900
0.55	1.00 ... 1.60	100	MS132-1.6	1SAM350000R1006 ■	6,060
0.75	1.60 ... 2.50	100	MS132-2.5	1SAM350000R1007 ■	6,060
1.5	2.50 ... 4.00	100	MS132-4.0	1SAM350000R1008 ■	6,200
2.2	4.00 ... 6.30	100	MS132-6.3	1SAM350000R1009 ■	6,340
4.0	6.30 ... 10.0	100	MS132-10	1SAM350000R1010 ■	6,800
5.5	8.00 ... 12.0	100	MS132-12	1SAM350000R1012 ■	7,810
7.5	10.0 ... 16.0	100	MS132-16	1SAM350000R1011 ■	9,270
9.0	16.0 ... 20.0	100	MS132-20	1SAM350000R1013 ■	9,540
12.5	20.0 ... 25.0	50	MS132-25	1SAM350000R1014 ■	9,720
15.5	25.0 ... 32.0	50	MS132-32	1SAM350000R1015 ■	16,760



## MS165 manual motor starters with short circuit, overload and phase loss protection

Ie current setting range Amp	S/C Icu breaking capacity kA	Type	Ordering code	L.P. (₹)
10 ... 16	100	MS165-16	1SAM451000R1011	15,910
14 ... 20	100	MS165-20	1SAM451000R1012	16,640
18 ... 25	100	MS165-25	1SAM451000R1013	17,050
23 ... 32	100	MS165-32	1SAM451000R1014 ■	18,280
30 ... 42	50	MS165-42	1SAM451000R1015 ■	19,680
40 ... 54	50	MS165-54	1SAM451000R1016 ■	23,920
52 ... 65	50	MS165-65	1SAM451000R1017 ■	25,440
62 ... 73	-	MS165-73	1SAM451000R1018	27,490
70 ... 80	-	MS165-80	1SAM451000R1019	28,550

■ Stock items

# Manual motor starter

With thermal and electromagnetic protection

## MO132 Manual motor starters with short circuit protection only



Rated power 415V KW	Rated operational current Amp	S/C Icu breaking capacity kA	Type	Ordering code	L.P. (₹)
0.03	0.16	100	MO132-0.16	1SAM360000R1001	5,240
0.06	0.25	100	MO132-0.25	1SAM360000R1002	5,240
0.09	0.40	100	MO132-0.4	1SAM360000R1003	5,240
0.12	0.63	100	MO132-0.63	1SAM360000R1004	5,910
0.25	1.0	100	MO132-1.0	1SAM360000R1005 ■	5,990
0.55	1.6	100	MO132-1.6	1SAM360000R1006 ■	5,990
0.75	2.5	100	MO132-2.5	1SAM360000R1007 ■	5,990
1.5	4.0	100	MO132-4.0	1SAM360000R1008 ■	6,270
2.2	6.3	100	MO132-6.3	1SAM360000R1009 ■	6,270
4.0	10	100	MO132-10	1SAM360000R1010 ■	6,600
5.5	12	100	MO132-12	1SAM360000R1012 ■	7,000
7.5	16	100	MO132-16	1SAM360000R1011 ■	7,280
9.0	20	100	MO132-20	1SAM360000R1013 ■	8,120
12.5	25	50	MO132-25	1SAM360000R1014 ■	8,400
15.5	32	50	MO132-32	1SAM360000R1015 ■	16,990

## MO165 Manual motor starters with short circuit protection only



Rated operational current Amp	S/C Icu breaking capacity kA	Type	Ordering code	L.P. (₹)
16	100	MO165-16	1SAM461000R1011	16,160
20	100	MO165-20	1SAM461000R1012	16,980
32	100	MO165-32	1SAM461000R1014 ■	17,300
42	50	MO165-42	1SAM461000R1015	18,190
54	50	MO165-54	1SAM461000R1016 ■	18,950
65	50	MO165-65	1SAM461000R1017	19,690
73	30	MO165-73	1SAM461000R1018	23,830
80	30	MO165-80	1SAM461000R1019	26,130

## MS132-T circuit breakers for transformer protection

### Description

MS132-T Circuit breakers for transformer protection are electro-mechanical protection devices specially designed to protect control transformers on the primary side.

The short-circuit current setting is fixed to 20 times the operating current to handle the high inrush current generated by transformers.



Ie current setting range Amp	S/C Icu breaking capacity kA	Type	Ordering code	L.P. (₹)
0.10 ... 0.16	100	MS132-0.16T	1SAM340000R1001	6,210
0.16 ... 0.25	100	MS132-0.25T	1SAM340000R1002	6,210
0.25 ... 0.40	100	MS132-0.4T	1SAM340000R1003	6,210
0.40 ... 0.63	100	MS132-0.63T	1SAM340000R1004	6,750
0.63 ... 1.00	100	MS132-1.0T	1SAM340000R1005	6,800
1.00 ... 1.60	100	MS132-1.6T	1SAM340000R1006	7,120
1.60 ... 2.50	100	MS132-2.5T	1SAM340000R1007	7,120
2.50 ... 4.00	100	MS132-4.0T	1SAM340000R1008 ■	7,160
4.00 ... 6.30	100	MS132-6.3T	1SAM340000R1009 ■	7,260
6.30 ... 10.0	100	MS132-10T	1SAM340000R1010 ■	7,750
8.00 ... 12.0	100	MS132-12T	1SAM340000R1012	8,560
10.0 ... 16.0	100	MS132-16T	1SAM340000R1011 ■	8,560
16.0 ... 20.0	100	MS132-20T	1SAM340000R1013	10,330
20.0 ... 25.0	50	MS132-25T	1SAM340000R1014	10,360

■ Stock items

# Manual motor starter

MS116, MS132, MO132, MS165 and MO165

## General accessories

### Description

With this solution of door coupling rotary mechanism it is possible to operate a Manual Motor Starter in the back of a switch cabinet from outside. The door coupling mechanism prevents opening of the door of a switch cabinet with the Manual Motor Starter in ON position. The complete mechanism includes handle, shaft, driver, shaft alignment ring and shaft supporter. All accessories fit for 6 mm shafts with a maximum length of 180 mm. The degree of protection for handles MSHD is IP64.

### Ordering details

Frame	Description	Type	Ordering code	L.P.(₹)
	SHAFT - Shaft diameter 6 mm. Shaft extension for door coupling driver	OX56X130	1SCA101655R1001	590
MS116	MSHD - Handle	MSHD-LB1	1SAM201920R1001	1,660
MS132		MSHD-LY2	1SAM201920R1002	1,660
MO132		MSHD-LTB3	1SAM201920R1011	1,660
MS165 MO165		MSHD-LTY3	1SAM201920R1012	1,660
	MSMN- Driver	MSMN4	1SAM101923R0002	240
		MSMNO5	1SAM101923R0012	240
	MSH-AR Shaft alignment ring	MSH-AR	1SAM201920R1000	280
MS116, MS132	MSAH1-Shaft supporter	MSAH1	1SAM201909R1021	1,100

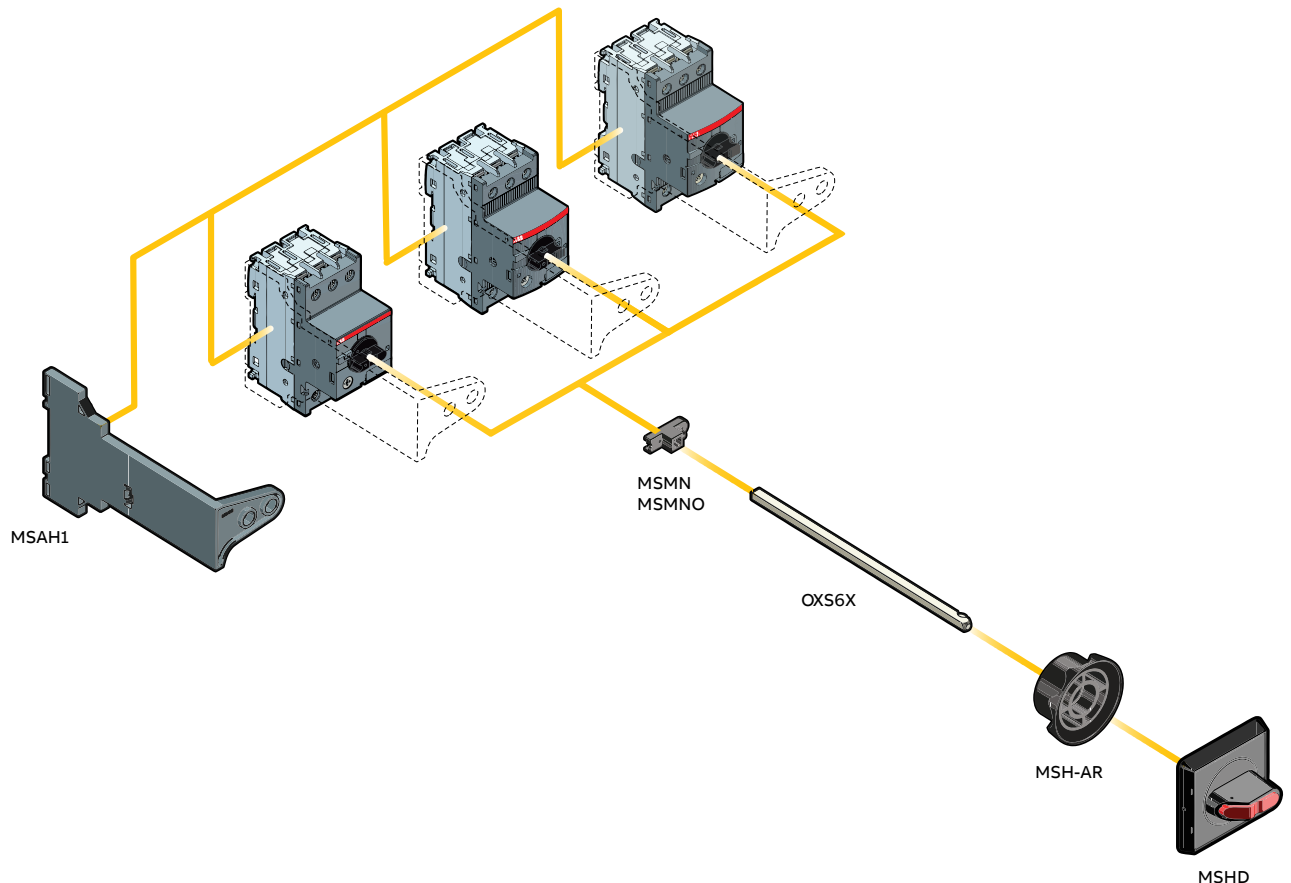

■ Stock items

# Manual motor starter

Accessories for MS116, MS132, MO132, MS132-T, MS165, MO165



AA1-24

Shunt trip				
Suitable for	Rated voltage	Type	Ordering code	L.P.(₹)
MS116, MS132, MO132, MS132-T MS165 MO165	20 ... 24	AA1-24	1SAM201910R1001	4,390
	110	AA1-110	1SAM201910R1002 ■	4,390
	200-240	AA1-230	1SAM201910R1003 ■	4,390
	350-415	AA1-400	1SAM201910R1004	4,390
Undervoltage release				
	24	UA1-24	1SAM201904R1001	3,590
	110	UA1-110	1SAM201904R1004	3,590
	230	UA1-230	1SAM201904R1005	3,590
	415	UA1-415	1SAM201904R1007	3,590



HKF1-11

Auxiliary contacts – mountable on the front				
Suitable for	Aux contacts	Type	Ordering code	L.P.(₹)
MS116, MS132, MO132, MS132-T MS165 MO165	1NO+1NC	HKF1-11	1SAM201901R1001 ■	870
	2 NO	HKF1-20	1SAM201901R1002 ■	870
	1NO	HKF1-10	1SAM201901R1003 ■	550
	1NC	HKF1-01	1SAM201901R1004 ■	550
Auxiliary contacts – mountable on the right				
		HK1-11	1SAM201902R1001 ■	1,180
		HK1-20	1SAM201902R1002 ■	1,180
		HK1-02	1SAM201902R1003 ■	1,180



SK1-11

CK1-11

Suitable for	Aux contacts	Type	Ordering code	L.P.(₹)
MS116, MS132,	1NO+1NC	SK1-11**	1SAM201903R1001 ■	1,600
MO132, MS 165	2 NO	SK1-20**	1SAM201903R1002 ■	1,600
MO 165 MS132-T	2 NC	SK1-02**	1SAM201903R1003	1,600
MS132	1NO+1NC	CK1-11#	1SAM301901R1001 ■	2,250
MS132-T	2 NO	CK1-20#	1SAM301901R1002 ■	2,250
MS165	2 NC	CK1-02#	1SAM301901R1003	2,250

\*\*for tripped alarm, max 2 piece

#for short-circuit alarm, max. 2 pieces

# Thermal overload relays



## TA25, TA42 and TA75 relays

Relay range in Amps	Direct mounting on contactors	Type code reference	Ordering code	L.P.(₹)
0.1 ... 0.16		TA25DU 0.16M	1SAZ211201R2005 ■	1,940
0.16 ... 0.25		TA25DU 0.25M	1SAZ211201R2009 ■	1,940
0.25 ... 0.4		TA25DU 0.4M	1SAZ211201R2013 ■	1,940
0.4 ... 0.63		TA25DU 0.63M	1SAZ211201R2017 ■	1,940
0.63 ... 1.0		TA25DU 1.0M	1SAZ211201R2021 ■	1,940
1.0 ... 1.4		TA25DU 1.4M	1SAZ211201R2023 ■	1,940
1.3 ... 1.8		TA25DU 1.8M	1SAZ211201R2025 ■	1,940
1.7 ... 2.4	A9...A40	TA25DU 2.4M	1SAZ211201R2028 ■	1,940
2.2 ... 3.1	AX9...AX40	TA25DU 3.1M	1SAZ211201R2031 ■	1,940
2.8 ... 4.0	AL9...AL40	TA25DU 4.0M	1SAZ211201R2033 ■	1,940
3.5 ... 5.0	TAL9...TAL40	TA25DU 5.0M	1SAZ211201R2035 ■	1,940
4.5 ... 6.5		TA25DU 6.5M	1SAZ211201R2038 ■	1,940
6.0 ... 8.5		TA25DU 8.5M	1SAZ211201R2040 ■	1,940
7.5 ... 11.0		TA25DU 11M	1SAZ211201R2043 ■	1,940
10.0 ... 14.0		TA25DU 14M	1SAZ211201R2045 ■	1,940
13.0 ... 19.0		TA25DU 19M	1SAZ211201R2047 ■	2,400
18.0 ... 25.0		TA25DU 25M	1SAZ211201R2051 ■	2,400
24.0 ... 32.0		TA25DU 32M	1SAZ211201R2053 ■	2,400
<b>TA42DU</b>				
18.0 ... 25.0	A30,A40, AX32...AX40	TA42DU 25	1SAZ311201R2001 ■	3,980
22.0 ... 32.0	AL30,AL40, TAL30,TAL 40	TA42DU 32	1SAZ311201R2002 ■	4,330
29.0 ... 42.0		TA42DU 42	1SAZ311201R2003 ■	4,330
<b>TA75DU</b>				
22 ... 32		TA75DU 32	1SAZ321201R2002 ■	5,010
29 ... 42		TA75DU 42	1SAZ321201R2003 ■	5,890
36 ... 52	A50...A75 AX50...AX80	TA75DU 52	1SAZ321201R2004 ■	5,890
45 ... 63		TA75DU 63	1SAZ321201R2005 ■	5,890
60 ... 80		TA75DU 80	1SAZ321201R2006 ■	6,320
<b>TA80DU</b>				
29 ... 42		TA80DU-42M	1SAZ331201R2003 ■	7,250
36 ... 52	A95...A110, AX95...AX150	TA80DU-52M	1SAZ331201R2004 ■	7,250
45 ... 63		TA80DU-63M	1SAZ331201R2005 ■	7,250
60 ... 80		TA80DU-80M	1SAZ331201R2006 ■	7,800
TA25/TA42/TA75/TA80/TA110/TA200 are direct operated relays with trip class 10A				
<b>TA110DU</b>				
66 ... 90		TA110DU-90	1SAZ411201R1001 ■	12,080
80 ... 110	A95...A110, AX95...AX150	TA110DU-110	1SAZ411201R1002 ■	13,110
65.0 ... 90.0 A		TA110DU-90M	1SAZ411201R2001	Upon request
80.0 ... 110.0 A		TA110DU-110M	1SAZ411201R2002	Upon request
<b>TA200DU</b>				
66 ... 90		TA200DU-90	1SAZ421201R1001 ■	13,900
80 ... 110		TA200DU-110	1SAZ421201R1002 ■	15,060
100 ... 135	A145...A185 AX185...AX205	TA200DU-135	1SAZ421201R1003 ■	16,060
110 ... 150	AF190, AF205	TA200DU-150	1SAZ421201R1004 ■	17,500
130 ... 175		TA200DU-175	1SAZ421201R1005 ■	18,210
150 ... 200		TA200DU-200	1SAZ421201R1006 ■	19,040
<b>Accessories</b>				
	TA25DU0.16..25A	DB25/25	1SAZ201108R0001 ■	480
Independent Mounting Kit	TA25DU32	DB25/32	1SAZ201108R0002	1,030
	TA42DU,TA75DU, TA80DU	DB80	1SAZ301110R0001 ■	4,520
	TA110DU, TA200DU	DB200	1SAZ401110R0001 ■	4,690

■ Stock items



# Thermal overload relays



TF42

## T16 Relays

Relay range in Amps	Direct mounting on contactors	Type code reference	Ordering code	L.P. (₹)
0.10 ... 0.13		T16-0.13	1SAZ711201R1005	Upon request
0.13 ... 0.17		T16-0.17	1SAZ711201R1008	
0.17 ... 0.23		T16-0.23	1SAZ711201R1009	
0.23 ... 0.31		T16-0.31	1SAZ711201R1013	
0.31 ... 0.41		T16-0.41	1SAZ711201R1014	
0.41 ... 0.55		T16-0.55	1SAZ711201R1017	
0.55 ... 0.74		T16-0.74	1SAZ711201R1021	
0.74 ... 1.00	B6/BC6	T16-1.0	1SAZ711201R1023	
1.00 ... 1.30	B7/BC7	T16-1.3	1SAZ711201R1025	
1.30 ... 1.70	VB6/VBC6	T16-1.7	1SAZ711201R1028	
1.70 ... 2.30	VB7/VBC7	T16-2.3	1SAZ711201R1031	
2.30 ... 3.10	AS/ASL	T16-3.1	1SAZ711201R1033	
3.10 ... 4.20	DOL starter IP65	T16-4.2	1SAZ711201R1035	
4.20 ... 5.70		T16-5.7	1SAZ711201R1038 ■	
5.70 ... 7.60		T16-7.6	1SAZ711201R1040	
7.60 ... 10.0		T16-10	1SAZ711201R1043	
10.0 ... 13.0		T16-13	1SAZ711201R1045	
13.0 ... 16.0		T16-16	1SAZ711201R1047	

## TF42 Relays

Relay range in Amps	Direct mounting on contactors	Type code reference	Ordering code	L.P. (₹)
0.10 ... 0.13		TF42-0.13	1SAZ721201R1005	Upon request
0.13 ... 0.17		TF42-0.17	1SAZ721201R1008	
0.17 ... 0.23		TF42-0.23	1SAZ721201R1009	
0.23 ... 0.31		TF42-0.31	1SAZ721201R1013	
0.31 ... 0.41		TF42-0.41	1SAZ721201R1014	
0.41 ... 0.55		TF42-0.55	1SAZ721201R1017	
0.55 ... 0.74		TF42-0.74	1SAZ721201R1021	
0.74 ... 1.00		TF42-1.0	1SAZ721201R1023	
1.00 ... 1.30		TF42-1.3	1SAZ721201R1025	
1.30 ... 1.70		TF42-1.7	1SAZ721201R1028 ■	
1.70 ... 2.30		TF42-2.3	1SAZ721201R1031 ■	
2.30 ... 3.10	AF09...AF38	TF42-3.1	1SAZ721201R1033 ■	
3.10 ... 4.20		TF42-4.2	1SAZ721201R1035 ■	
4.20 ... 5.70		TF42-5.7	1SAZ721201R1038 ■	
5.70 ... 7.60		TF42-7.6	1SAZ721201R1040 ■	
7.60 ... 10.0		TF42-10	1SAZ721201R1043	
10.0 ... 13.0		TF42-13	1SAZ721201R1045 ■	
13.0 ... 16.0		TF42-16	1SAZ721201R1047 ■	
16.0 ... 20.0		TF42-20	1SAZ721201R1049	
20.0 ... 24.0		TF42-24	1SAZ721201R1051	
24.0 ... 29.0		TF42-29	1SAZ721201R1052	
29.0 ... 35.0		TF42-35	1SAZ721201R1053	
35.0 ... 38.0/40.0		TF42-38	1SAZ721201R1055	

■ Stock items

# Thermal overload relays



TF42

## TF65/TF96/TF140 Relay

Relay range in Amps	Direct mounting on contactors	Type code reference	Ordering code	L.P. (₹)
22.0...28.0	AF40, AF52, AF65	TF65-28	1SAZ811201R1001	Upon request
25.0...33.0		TF65-33	1SAZ811201R1002	
30.0...40.0		TF65-40	1SAZ811201R1003	
36.0...47.0		TF65-47	1SAZ811201R1004	
44.0...53.0		TF65-53	1SAZ811201R1005	
50.0...60.0		TF65-60	1SAZ811201R1006	
57.0...67.0		TF65-67	1SAZ811201R1007	
40.0...51.0	AF80, AF96	TF96-51	1SAZ911201R1001	
48.0...60.0		TF96-60	1SAZ911201R1002	
57.0...68.0		TF96-68	1SAZ911201R1003	
65.0...78.0		TF96-78	1SAZ911201R1004	
75.0...87.0		TF96-87	1SAZ911201R1005	
84.0...96.0	TF96-96	1SAZ911201R1006		
66...90	AF116, AF140	TF140DU-90	1SAZ431201R1001	
80...110		TF140DU-110	1SAZ431201R1002	
100...135		TF140DU-135	1SAZ431201R1003	
110...142		TF140DU-142	1SAZ431201R1004	

For AF190 and AF205 use TA200DU OLR

Description	Type	Ordering code	L.P. (₹)
Separate mounting kit	DB16E	1SAX101110R0001 ■	Upon request
Separate mounting kit	DB42	1SAZ701902R0001 ■	
Separate mounting kit for TF65	DB65	1SAZ801901R1001	
Separate mounting kit for TF96	DB96	1SAZ901901R1001	

## Electronic overload relays and suitable contactors

Suitable for Contactor	A9 ... A16 TAL9...TAL16	A26 ... A40	A50 ... A75	A95, A110	AF190, AF205			
EOLR	AL9 ... AL16	AL30 ... AL40	E16DU	E45DU	E80DU	E140DU	EF205	
Suitable for Contactor	AF400, AF460	AF580, AF750	AF1350, AF1650	B6/BC6	B7/BC7			
EOLR	EF460	EF750	E1250DU	E16DU, T16				
Suitable for Contactor	AF09 ... AF16	AF26, AF38	AF40, AF52, AF65	AF80, AF96	AF116, AF140, AF146	AF265, AF305, AF370	AF400, AF460,	AF580, AF750, AF1250
EOLR	EF19	EF45	EF65	EF96	EF146	EF370	EF460	EF750

■ Stock items

# Electronic overload relays class 10, 20, 30



## Electronic overload relays

### Trip class 10, 20, 30 selectable

Setting range	Trip class	Type	Ordering code	L.P.(₹)	
0.1... 0.32A	Selectable 10E, 20E and 30E	E16DU 0.32	1SAX111001R1101	10,980	
0.3 ... 1.0A		E16DU 1.0	1SAX111001R1102	10,980	
0.8 ... 2.7A		E16DU 2.7	1SAX111001R1103 ■	10,980	
1.9 ... 6.3A		E16DU 6.3	1SAX111001R1104 ■	12,130	
5.7... 18.9A		E16DU 18.9	1SAX111001R1105 ■	12,130	
9 ... 30A		E45DU 30	1SAX211001R1101 ■	15,620	
15 ... 45A		E45DU 45	1SAX211001R1102 ■	17,010	
27 ... 80A		E80DU 80	1SAX311001R1101 ■	22,340	
50 ... 140A		E140DU 140	1SAX321001R1101 ■	26,900	
63 ... 210A		EF205-210	1SAX531001R1101	Upon request	
115 ... 380A		EF370-380	1SAX611001R1101	Upon request	
150 ... 500A		EF460	1SAX721001R1101 ■	Upon request	
250 ... 800A		EF750	1SAX821001R1101	Upon request	
375 ... 1250A		E1250DU 375 - 1250 A	1SFA739001R1000	Upon request	
0.10...0.32A		Selectable 10E, 20E and 30E	EF19-0.32	1SAX121001R1101	Upon request
0.30...1.00A			EF19-1.0	1SAX121001R1102	
0.80...2.70A	EF19-2.7		1SAX121001R1103 ■		
1.90...6.30A	EF19-6.3		1SAX121001R1104 ■		
5.70...18.9A	EF19-18.9		1SAX121001R1105 ■		
9.00...30.0A	EF45-30		1SAX221001R1101 ■		
15.0...45.0A	EF45-45		1SAX221001R1102 ■		
25...70A	EF65-70		1SAX331001R1101 ■		
36...100A	EF96-100		1SAX341001R1101 ■		
54...150A	EF146-150		1SAX351001R1101 ■		
63 ... 210A	EF205-210		1SAX531001R1101 ■		
115 ... 380A	EF370-380		1SAX611001R1101 ■		
150 ... 500A	EF460		1SAX721001R1101		
250 ... 800A	EF750		1SAX821001R1101		

## Accessories

Description	Type	Ordering code	L.P.(₹)
Separate mounting kit	DB16E	1SAX101110R0001	3,510
Separate mounting kit - EF19	DB19EF	1SAX101910R1001 ■	3,550
Separate mounting kit - EF45	DB45EF	1SAX201910R0001 ■	5,670
Separate mounting kit	DB45E	1SAX201110R1001	5,670
Separate mounting kit	DB80E	1SAX301110R1001 ■	7,070
Separate mounting kit	DB140E	1SAX301110R1002	10,220

For suitable contactors refer page no. 101

■ Stock items

# Push-in Spring solution

## Complete range, complete efficiency

**NEW**

The Push-in Spring motor starting solution products provide you with a range of benefits.

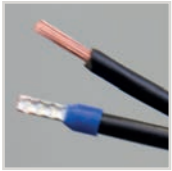

**2-in-1**  
Benefit from both Push-in mode and Spring mode and use ferruled cables or cables without ferrules in the same terminal.



**Tool-free connecting links**  
100% tool-free mounting connecting links.



**Compatible with screw range**  
Mount accessories for control circuits on the screw range up to 45 kW AC-3 400 V on manual motor starters and up to 45 kW AC-3 400 V, 130 A AC-1 on contactors.

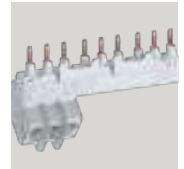

**Tool-free busbars**  
Parallel connection of manual motor starters without the need for tools (also certified for UL Type E/ Type F applications)



**Just one tool for everything**  
You only need a 3 mm screwdriver in Spring mode as well as for de-wiring the complete solution.



**Higher connecting capacity**  
The solution ranges up to 18.5 kW 400 V AC-3 and 50 A AC-1 (25 hp 480 V and 45 A 600 V general use).

# Just push it!

NEW

The next evolution in motor starter solutions is here.

So up to 18.5 kW, one push is all you need!

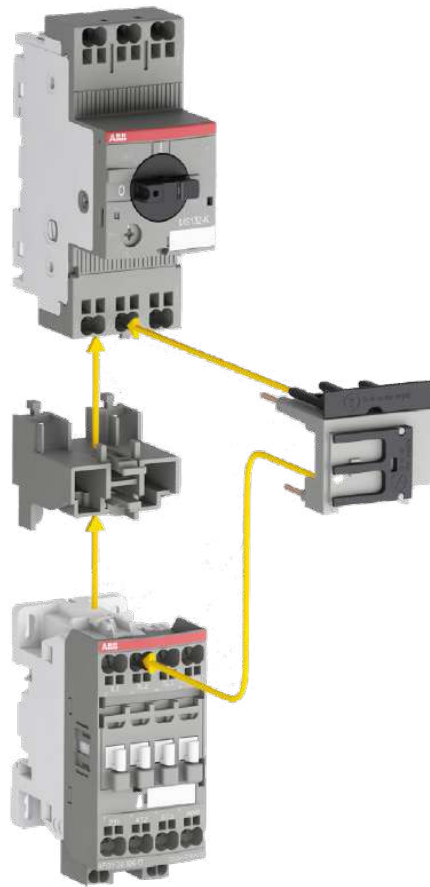

Direct on-line Starter



Reversing Starter



Star-Delta Starter

Save up to 50% wiring time with Push-in Spring compared to conventional spring solutions. And the connections are just as reliable. So for speed, ease and reliability, just push it.

**NEW**

**Benefits / Features**

- Fast and intuitive wiring
- Tool-free mounting
- Vibration & shock proof
- Robust design for higher up-time
- Future proof connection technology
- Terminals accessible from the front
- One-hand mounting
- 2-in-1 Push-in / Spring
- Higher connection capacity
- No mounting plate required for starters
- Enabled for automated wiring

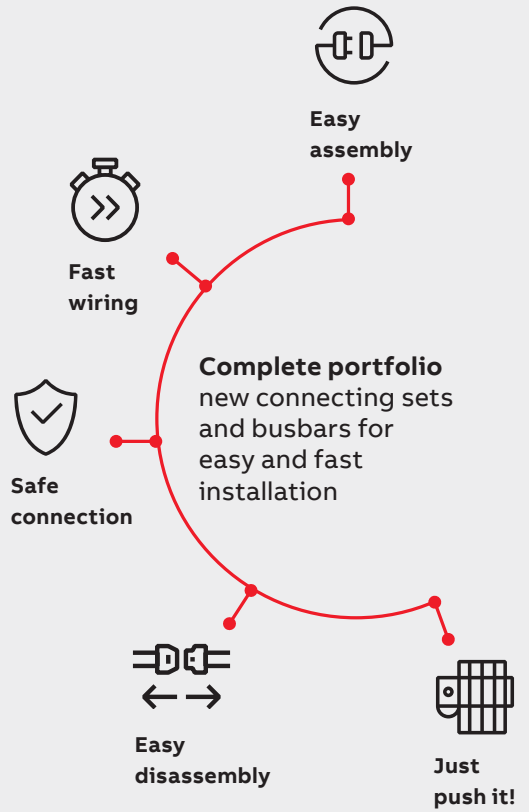

CA4..K, CAL4-11K 1, 2 and 4 pole auxiliary contacts

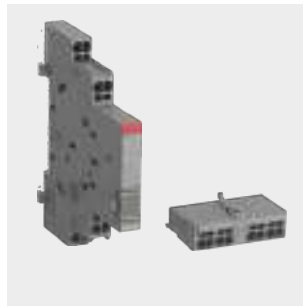

HK1-K, HKF1-K auxiliary contacts



SK1-K and SK1-ARK signaling contacts



PS1...-65K busbars for 2, 3, 4 or 5 manual motor starters



TS1-M3-K terminal spacer for UL Type E/F combination motor controllers



BEA16-4KF and BEA38-4KF connecting links with manual motor starters



BER16-4KF and BER38-4KF connecting links for reversing starters



BEY16-4KF and BEY38-4KF connection sets for Star-Delta starters



VEM4K electrical and mechanical interlock

158C0044550201

# Softstarters

## Motor starting matters

ABB softstarters offering consists of three ranges, covering every need. The products help you secure motor reliability, improve installation efficiency and increase application productivity.



### PSR – The compact range

- When soft start and stop benefits and values are requested
- When operating a small motor
- When up to 100 starts per hour are requested

### PSE – The efficient range

- When there is limited space
- When common softstarter functions and protections are needed
- When communication is needed

### PSTX – The advanced range

- When full control and motor protection is needed
- When an advanced softstarter with an extensive functionality is needed
- When motor is connected inside delta or in 690 V

PSR	PSE	PSTX	• Standard, O Optional, - Not available
•	•	•	Built-in by-pass
-	-	•	Inside delta connection
-	•	•	Coated PCBs
-	•	•	Display and keypad,
-	•	•	Torque control / Pump control
-	•	•	Settable current limit function
-	•	•	Electronic motor overload protection
-	-	•	PTC input for motor protection
-	-	•	Phase imbalance protection
-	-	•	Phase reversal protection
-	•	•	Locked rotor protection
-	•	•	Thyristor overtemperature protection
-	•	•	Underload protection
-	-	•	UV/OV protection
-	-	•	Programmable warning functions
-	•	•	Analog output
O	• <sup>1</sup>	• <sup>1</sup>	FieldBus communication
-	O	•	Event log
-	O	• <sup>2</sup>	External keypad
-	-	•	Motor heating
-	-	•	Pump cleaning
-	-	•	Limp mode
-	-	•	Network diagnostics

1 - built in Modbus-RTU  
2 - detachable key pad

### PSR18 - 600 -70

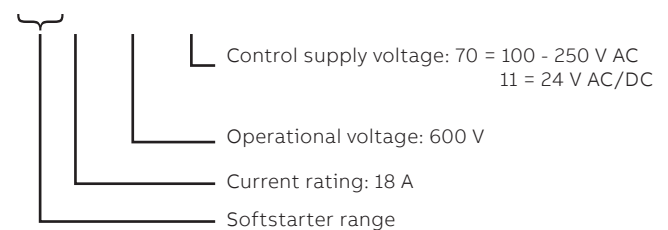

# Softstarters

## PSR - The compact range



- Rated operational current: 3...105 A
- Operational voltage: 208...600 V AC
- Wide rated control supply voltage: 100...240 V AC, 50/60 Hz or 24 V AC/DC
- Two-phase controlled
- Soft start and soft stop with voltage ramp

- Built-in bypass for energy saving and easy installation
- Fieldbus communication with fieldbus plug adapter and the fieldbus plug

### PSR3 ... PSR105

**Rated operational voltage U<sub>e</sub>, 208-600 V AC**  
**Rated control supply voltage, U<sub>s</sub>, 100 - 240 V AC**



415V Pe kW"	IEC Max rated operational I <sub>e</sub> A	Type	Order code	L.P. (₹)
1.5	3.9	PSR3-600-70	1SFA896103R7000	16,480
3	6.8	PSR6-600-70	1SFA896104R7000	18,830
4	9	PSR9-600-70	1SFA896105R7000	21,420
5.5	12	PSR12-600-70	1SFA896106R7000	25,430
7.5	16	PSR16-600-70	1SFA896107R7000	31,080
11	25	PSR25-600-70	1SFA896108R7000	34,330
15	30	PSR30-600-70	1SFA896109R7000	44,780
18.5	37	PSR37-600-70	1SFA896110R7000	56,280
22	45	PSR45-600-70	1SFA896111R7000	61,650
30	60	PSR60-600-70	1SFA896112R7000	81,740
37	72	PSR72-600-70	1SFA896113R7000	1,01,530
45	85	PSR85-600-70	1SFA896114R7000	1,14,610
55	105	PSR105-600-70	1SFA896115R7000	1,24,990

For rated control supply voltage, U<sub>s</sub>, 24 V Dc replace R7000 by R1100

## PSE - The efficient range



- Rated operational current: 18...370 A
- Operational voltage: 208...600 V AC
- Wide rated control supply voltage: 100...250 V AC, 50/60 Hz
- Voltage ramp and torque control for both start and stop
- Two-phase controlled, Current limit and Kick-start
- Built-in bypass for energy saving and easy installation

- External keypad rated IP66 (Type 1, 4X,12) as an option
- **NEW** Built-in modbus-RTU communication for monitoring and control
- Fieldbus communication with fieldbus plug adapter and the fieldbus plug
- Analog output for display of motor current
- Electronic overload, Underload and locked rotor protection

### PSE18 ... PSE370

**Normal starts, Class 10, In-Line**  
**Rated operational voltage U<sub>e</sub>, 208-600 V AC**  
**Rated control supply voltage, U<sub>s</sub>, 100 - 240 V AC**

415V Pe kW	IEC Max rated operational I <sub>e</sub> A	Type	Order code	L.P. (₹)
7.5	18	PSE18-600-70	1SFA897101R7000	69,770
11	25	PSE25-600-70	1SFA897102R7000	70,130
15	30	PSE30-600-70	1SFA897103R7000	75,130
18.5	37	PSE37-600-70	1SFA897104R7000	83,460
22	45	PSE45-600-70	1SFA897105R7000	87,780
30	60	PSE60-600-70	1SFA897106R7000	1,01,740
37	72	PSE72-600-70	1SFA897107R7000	1,11,040
45	85	PSE85-600-70	1SFA897108R7000	1,24,580
55	106	PSE105-600-70	1SFA897109R7000	1,41,180
75	143	PSE142-600-70	1SFA897110R7000	1,65,490
90	171	PSE170-600-70	1SFA897111R7000	2,00,520
110	210	PSE210-600-70-1	1SFA897112R7001	2,47,730
132	250	PSE250-600-70-1	1SFA897113R7001	2,69,940
160	300	PSE300-600-70-1	1SFA897114R7001	3,04,090
200	370	PSE370-600-70-1	1SFA897115R7001	3,32,040

For accessories consult



# Softstarters

## PSTX - The advanced range



- Rated operational current: 30 to 1250 A
- Three-phase controlled
- Operational voltage: 208 – 690 VAC
- Wide rated control supply voltage: 100 – 250 V, 50/60 Hz (inside-delta: 2160 A)
- Both in-line and inside-delta connection
- Coated circuit boards protecting from dust, moist and corrosive atmosphere
- Detachable keypad rated IP66 (4X outdoor)
- Built-in bypass for energy saving and easy installation
- Built-in Modbus RTU for monitoring and control
- Support for all major communication protocols
- Analog output for measurement of current, voltage, power factor etc.

### PSTX30 ... PSTX370

Normal starts, class 10, in-line, ordering details

Rated operational voltage  $U_e$ , 208-600 V

Rated control supply voltage  $U_s$ , 100-250 V AC, 50/60 Hz



415V $P_e$ kW	IEC Max rated operational I <sub>e</sub> A	Type	Ordering code	L.P. (₹)
15	30	PSTX30-600-70	1SFA898103R7000	
18.5	37	PSTX37-600-70	1SFA898104R7000	
22	45	PSTX45-600-70	1SFA898105R7000	
30	60	PSTX60-600-70	1SFA898106R7000	
37	72	PSTX72-600-70	1SFA898107R7000	
45	85	PSTX85-600-70	1SFA898108R7000	
55	106	PSTX105-600-70	1SFA898109R7000	
75	143	PSTX142-600-70	1SFA898110R7000	
90	171	PSTX170-600-70	1SFA898111R7000	
110	210	PSTX210-600-70	1SFA898112R7000	Upon request
132	250	PSTX250-600-70	1SFA898113R7000	
160	300	PSTX300-600-70	1SFA898114R7000	
200	370	PSTX370-600-70	1SFA898115R7000	
250	470	PSTX470-600-70	1SFA898116R7000	
315	570	PSTX570-600-70	1SFA898117R7000	
400	720	PSTX720-600-70	1SFA898118R7000	
450	840	PSTX840-600-70	1SFA898119R7000	
560	1050	PSTX1050-600-70	1SFA898120R7000	
710	1200	PSTX1250-600-70	1SFA898121R7000	

For 690 V Contact nearest sales office

For inside-delta contact nearest sales office

### Soft starter communication accessories

For communication protocol	Type	Ordering code	L.P. (₹)
Profibus	AB-PROFIBUS-1	1SFA899300R1001	
Devicenet	AB-DEVICENET-1	1SFA899300R1002	
Modbus-RTU	AB-MODBUS-RTU-1	1SFA899300R1003	
EtherNet/IP (1-port)	AB-ETHERNET-IP-1	1SFA899300R1005	Upon request
EtherNet/IP (2-port)	AB-ETHERNET-IP-2	1SFA899300R1006	
Modbus TCP (1-port)	AB-MODBUS-TCP-1	1SFA899300R1007	
Modbus TCP (2-port)	AB-MODBUS-TCP-2	1SFA899300R1008	
Profinet (2-port)	AB-PROFINET-2	1SFA899300R1010	



EtherNet/IP (2-port)  
Modbus TCP (2-port)  
Profinet (2-port)



EtherNet/IP (1-port)  
Modbus TCP (1-port)



Profibus  
Modbus-RTU

# AFS contactors with front-mounted auxiliary contact blocks

Dedicated for safety applications

ABB's complete range of safety components make protection systems easier to build. Designed for machine safety applications, AFS contactors come with fixed

front auxiliary contact blocks, making them ideal for monitoring and controlling circuits. Mechanically linked and mirror contacts help make your system safer.

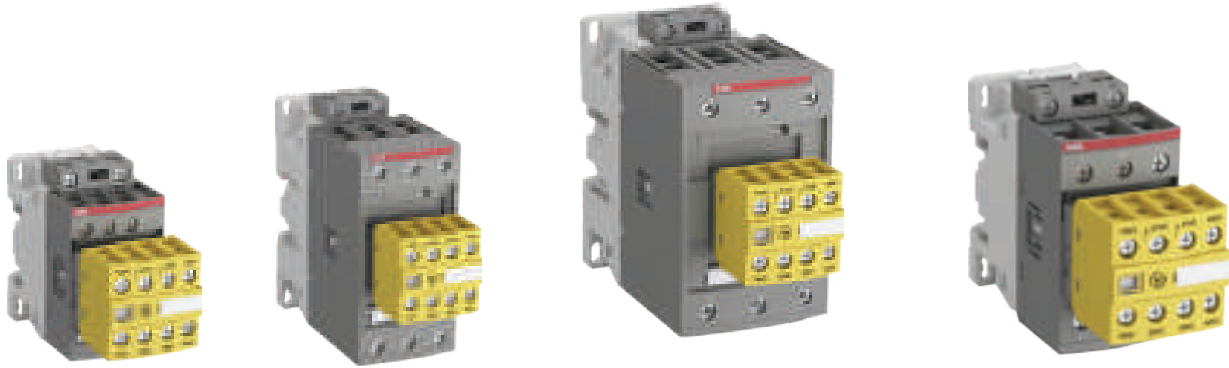

Safety and protection

## Safety in all things

ABB's AFS contactors can be easily integrated in machine manufacturer's systems complying with main safety standards EN ISO 13849 and EN 62061 guaranteeing the safe use of your machinery and equipment. The AFS contactor range is an integral part of ABB's comprehensive range of safety products.



Continuous operation

## Secure uptime

The AFS contactor secures system uptime. It allows direct control by relay outputs of safety PLCs and safety relays to ensure the safety performance customers require. A low energy auxiliary contact guarantees system status feedback.

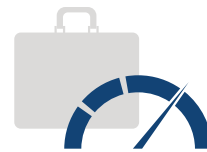

Speed up your projects

## Simplify design

Perfect design makes integration easier. ABB's distinctive yellow auxiliary contact block makes identifying the right product quicker. By reducing the contactor coil's power consumption, panels can also be made smaller and transformers more compact. In addition, all the safety data for the contactors are readily available using safety design tools.

Note: Contact our nearest sales office for more information

# M mini contactors and contactor relays **NEW**

Reliability, always

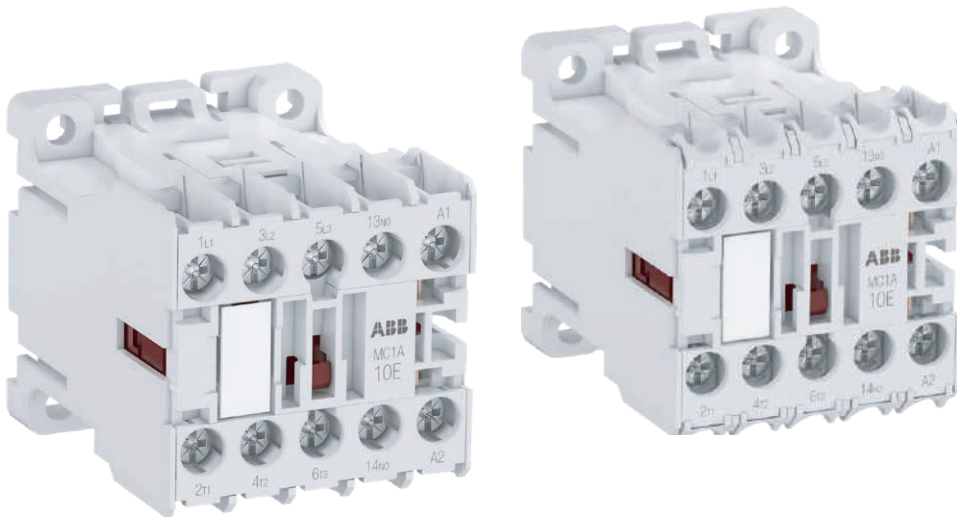

The M contactors range is a performance-dimension optimized solution for all the purposes. Its high reliability, even in extreme conditions, combined to the small sizes and the safe connections lead to easy design and compact panels.

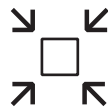

## Space-saving

### Small dimensions for big projects

The M range devices are a great solution when high performances are needed but the space is limited. The small dimensions of the products and the possibility to mount them side by side will maximize the cost efficiency of the cabinets without making compromises.



## Reliability in extreme conditions

### Made for all the applications

The technology used in the design of the contactors and the wide set of variants available guarantee reliability of operation with heavy working conditions as well. Instability of the network, high altitude and extreme temperatures will not be a limit anymore.



## Optimum interface

### Never without a solution

A wide set of coils is provided for matching all the requirements: pure AC or DC for very fast switching, with low energy consumption for direct control by PLC and with extended operating limits to face voltage fluctuations. A complete offer for realizing your projects.

# M Mini contactors with screw connection

**NEW**

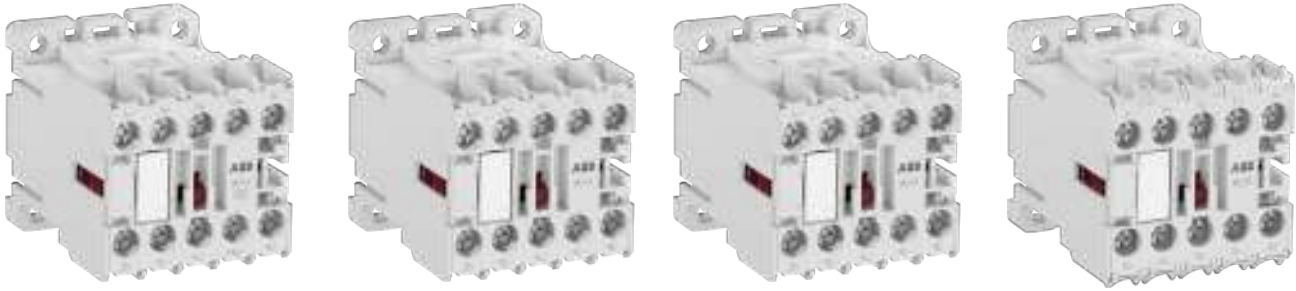

## 3 pole - AC operated

AC1 duty Amps	hP	kW	Aux Contacts	coil Voltage	Type code reference	Ordering code	L.P.(₹)	Coil Voltage	Type code reference	Ordering code	L.P.(₹)
20A	5	4	1NO	24	MC1A310AT1	1SAL102617R9901		12	MC1C310ATB	1SAL100210R9901	
20A	5	4	1NC	24	MC1A301AT1	1SAL102638R9901		12	MC1C301ATB	1SAL100220R9901	
20A	5	4	1NO	110..115	MC1A310ATJ	1SAL100213R9901		24	MC1C310ATD	1SAL100216R9901	
20A	5	4	1NC	110..115	MC1A301ATJ	1SAL100223R9901		24	MC1C301ATD	1SAL100226R9901	
20A	5	4	1NO	220..240	MC1A310ATN	1SAL100214R9901		24 with Diode	MC1C310ATDD	1SAL113312R9901	
20A	5	4	1NC	220..240	MC1A301ATN	1SAL100224R9901		24 with Diode	MC1C301ATDD	1SAL113328R9901	
20A	7.5	5.5	1NO	24	MC2A310AT1	1SAL103577R9902	Upon request	12	MC2C310ATB	1SAL103588R9902	Upon request
20A	7.5	5.5	1NC	24	MC2A301AT1	1SAL103569R9902		12	MC2C301ATB	1SAL103589R9902	
20A	7.5	5.5	1NO	110..115	MC2A310ATJ	1SAL103573R9902		24	MC2C310ATD	1SAL103584R9902	
20A	7.5	5.5	1NC	110..115	MC2A301ATJ	1SAL103565R9902		24	MC2C301ATD	1SAL103580R9902	
20A	7.5	5.5	1NO	220..240	MC2A310ATN	1SAL103574R9902		24 with Diode	MC2C310ATDD	1SAL101926R9902	
20A	7.5	5.5	1NC	220..240	MC2A301ATN	1SAL103566R9902		24 with Diode	MC2C301ATDD	1SAL101955R9902	

## 4 pole - AC operated

AC1 duty Amps	hP	kW	Main Pole	coil Voltage	Type code reference	Ordering code	L.P.(₹)	Coil Voltage	Type code reference	Ordering code	L.P.(₹)
20A	5	4	4NO	24	MC1A400AT1	1SAL102986R9901		24	MC1C400ATWD	1SAL220344R9901	
20A	5	4	2NO+2NC	24	MC1AB00AT1	1SAL103007R9901		24	MC1CB00ATWD	1SAL220345R9901	
20A	5	4	4NO	110..115	MC1A400ATJ	1SAL100363R9901		110	MC1C400ATWJ	1SAL220342R9901	
20A	5	4	2NO+2NC	110..115	MC1AB00ATJ	1SAL100373R9901		110	MC1CB00ATWJ	1SAL220343R9901	
20A	5	4	4NO	220..240	MC1A400ATN	1SAL100364R9901		220	MC1C400ATWN	1SAL220340R9901	
20A	5	4	2NO+2NC	220..240	MC1AB00ATN	1SAL100374R9901		220	MC1CB00ATWN	1SAL220341R9901	
20A	7.5	5.5	4NO	24	MC2A400AT1	1SAL101645R9902	Upon request	24	MC2C400ATWD	1SAL101961R9902	Upon request
20A	7.5	5.5	2NO+2NC	24	MC2AB00AT1	1SAL101648R9902		24	MC2CB00ATWD	1SAL101965R9902	
20A	7.5	5.5	4NO	110..115	MC2A400ATJ	1SAL116184R9902		110	MC2C400ATWJ	1SAL101963R9902	
20A	7.5	5.5	2NO+2NC	110..115	MC2AB00ATJ	1SAL110548R9902		110	MC2CB00ATWJ	1SAL101967R9902	
20A	7.5	5.5	4NO	220..240	MC2A400ATN	1SAL116177R9902		220	MC2C400ATWN	1SAL100445R9902	
20A	7.5	5.5	2NO+2NC	220..240	MC2AB00ATN	1SAL135699R9902		220	MC2CB00ATWN	1SAL101968R9902	

# M Mini contactor relay NEW

## MCRA/MCRC



### 4 pole - AC operated

### 4 pole - DC operated with extended operating limit

Contact configuration	coil Voltage	Type code reference	Ordering code	L.P.(₹)	Coil Voltage	Type code reference	Ordering code	L.P. (₹)
4NO	24	MCRA040AT1	1SAH102013R9900	Upon request	24	MCRC040ATD	1SAH100006R9900	Upon request
3NO 1NC	24	MCRA031AT1	1SAH102034R9900		24	MCRC031ATD	1SAH100016R9900	
2NO 2NC	24	MCRA022AT1	1SAH220438R9900		24	MCRC022ATD	1SAH100026R9900	
4NO	110..115	MCRA040ATJ	1SAH100003R9900		110	MCRC040ATWJ	1SAH220407R9900	
3NO 1NC	110..115	MCRA031ATJ	1SAH100013R9900		110	MCRC031ATWJ	1SAH220406R9900	
2NO 2NC	110..115	MCRA022ATJ	1SAH100023R9900		77..143	MCRC022ATWJ	1SAH107171R9900	
4NO	220..240	MCRA040ATN	1SAH100004R9900		220	MCRC040ATWN	1SAH220404R9900	
3NO 1NC	220..240	MCRA031ATN	1SAH100014R9900		220	MCRC031ATWN	1SAH220403R9900	
2NO 2NC	220..240	MCRA022ATN	1SAH100024R9900		220	MCRC022ATWN	1SAH220402R9900	

## Auxiliary contact blocks for mini contactors

### Ordering details

For contactor types	Auxiliary contacts	Type	Ordering code	L.P.(₹)
<b>Front mounted instantaneous auxiliary contact blocks</b>				
All MC1 and MC2 variants Contacts in accordance with EN 50012	1NO + 1NC	MACN211AT	1SAL100999R9906	Upon request
	2NO	MACN202AT	1SAL100998R9906	
	3NO + 1NC	MACN431AT	1SAL100995R9906	
	2NO + 2NC	MACN422AT	1SAL100996R9906	
	1NO + 3NC	MACN413AT	1SAL100997R9906	
<b>Side mounted instantaneous auxiliary contact block</b>				
All MC1 and MC2 variants Contacts in accordance with EN 50012	1NO	MACL110AT	1SAL100560R9906	Upon request
	1NC	MACL101AT	1SAL100561R9906	

For contactor types	Rated control circuit voltage	Type	Ordering code	L.P.(₹)
<b>Surge suppressors for contactor coils</b>				
All MC1 and MC2 variants	24-48 V AC / DC	MPODAE4	1SAL100536R9906	Upon request
	50-127 V AC / DC	MPODAE5	1SAL204848R9906	
	130-250 V AC / DC	MPODAE6	1SAL204849R9906	

For contactor types	Rated control circuit voltage	Time range	Type	Ordering code	L.P.(₹)
<b>Electronic timers</b>					
All MC1 and MC2 variants	24-250 V AC / DC	0.5 ... 60 sec.	MREBC10AC2	1SAL100541R9906	Upon request
		0.2 ... 24 sec.	MREBC20AC2	1SAL100542R9906	

# Electronic compact starters: HF range

A compact solution with great functionality

ABB's electronic compact starter, up to 3 kW / 400 V, is a 22.5 mm wide product. Even though its compact, it has, direct-on-line, reversed starting, motor overload

protection, and emergency stop all included. It is well suited for paper machines, conveyors or machine tools.

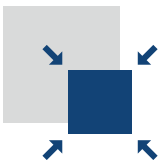

Space saving  
**Up to 90% less space required**



Safety and protection  
**Integrated safety function**



Easy to install  
**Up to 75% reduced time in wiring**

## HF range

Type	Ordering code	L.P.(₹)
HF0.6-DOL-24VDC	1SAT112000R1011	30,000
HF2.4-DOL-24VDC	1SAT122000R1011	30,000
HF9-DOL-24VDC	1SAT142000R1011	30,000
HF0.6-ROL-24VDC	1SAT115000R1011	33,000
HF2.4-ROL-24VDC	1SAT125000R1011	33,000
HF9-ROL-24VDC	1SAT145000R1011	33,000
HF0.6-DOLE-24VDC	1SAT113000R1011	37,000
HF2.4-DOLE-24VDC	1SAT123000R1011	37,000
HF9-DOLE-24VDC	1SAT143000R1011	37,000
HF0.6-ROLE-24VDC	1SAT116000R1011	40,000
HF2.4-ROLE-24VDC	1SAT126000R1011	40,000
HF9-ROLE-24VDC	1SAT146000R1011	40,000
HF9-R-VDC-24VDC	1SAT144000R1011	31,000

# Limit switches

NEW



ABB limit switches are the easiest reliable way to convert mechanical movements into electrical signals. Use our wide offer to match your application.



## Reliable in extreme conditions

Ready for anything

Plastic or metal casing limit switches are designed to operate in the most difficult environments. A high degree of protection up to IP67 and the positive contact opening, guarantee reliable operation.



## Continuous operation

Keep your installation running 24h a day

Limit switches secure your uptime. Their high mechanical durability can handle up to 30 million operations with contacts that are mechanically linked to actuators.



## Easy to install

Easy to use

Limit switches are easy to install and to use thanks to their three different types of electrical connections and cable length, in order to satisfy every design specifications.

# Limit switches

NEW



## LS2..

Compact

30 mm width - Prewired

IP67 - Plastic casing - Double insulation

IP67 - Metal casing

## LS3..

Standard

30 mm width - Cable inlet

IP65 - Plastic casing - Double insulation

IP66 - Metal casing



## LS4..

Standard reinforced

40 mm width - Cable inlet

IP65 - Plastic casing - Double insulation

IP66 - Metal casing



# Pilot devices

## Pilot Devices Offering

ABB Pilot Devices offers both modular and compact range of pushbuttons. Both feature the same front-of-panel design and appear consistent when combined.

**Modular range**, features a wide range of operators that can be combined with high flexibility. The unique snap-on design promotes simple and fast assembly.

**Compact range** features an all-in-one construction and rugged design for added simplicity and ease of installation.



Modular range

## Technical data compact range

Standard and approvals	
IEC / EN 60947-1	Low-voltage switchgear and controlgear - Part 1: General rules
IEC / EN 60947-5-1	Low-voltage switchgear and controlgear - Part 5-1: Control circuit devices and switching elements - Electromechanical control circuit devices
IEC / EN 60947-5-5	Low-voltage switchgear and controlgear - Part 5-5: Control circuit devices and switching elements - Electrical emergency stop device with mechanical latching function
IEC / EN 60073	Basic and safety principles for man-machine
IEC / EN 60529	Degrees of protection provided by enclosures (IP Code)
EN 50013	Low-voltage switchgear and controlgear for industrial use - Terminal marking and distinctive number for particular control switches
DIN 40050-9	Road vehicles; degrees of protection (IP-code); protection against foreign objects; water and contact; electrical equipment
UL 508	Industrial control equipment
CSA C22.2 No 14	Industrial control equipment

## Environmental data

### Degrees of protection

Pilot device:	IEC/EN DIN	UL/CSA
Pushbutton	IP66, IP67 and IP69K	Type 1, 3R, 4, 4X, 12, 13
Selector switch	IP66, IP67 and IP69K	Type 1, 3R, 4, 4X, 12, 13
Pilot light	IP66, IP67 and IP69K	Type 1, 3R, 4, 4X, 12, 13
Emergency stops	IP66, IP67 and IP69K	Type 1, 3R, 4, 4X, 12, 13
Terminals	IP20	

## Temperature

Ambient temperature during operation	-25 to +70 °C
Storage temperature	-40 to +85 °C

## Technical data

### Cable connections

Operator	Cable terminal
Pushbutton Selector switch Emergency stop	Plus-minus Pozidriv No. 2 Connectable area: min. 1 x 0.5 mm <sup>2</sup> /1 x AWG22 max. 2 x 1.5 mm <sup>2</sup> /2 x AWG14

### Tightening torque

Operators, M22	Min. 2 Nm / Max. 2.3 Nm
Pushbutton and selector switch	Cable terminals M3, 0.8 Nm
Pilot light	Cable terminals M3.5, 0.9 Nm
Emergency stop	Cable terminals M3, 0.8 Nm

## Electrical data

### Electrical ratings

#### Contacts

#### Ratings as per IEC 60947-5-1

Rated insulation voltage, U <sub>i</sub>	300 V	
Rated thermal current, I <sub>th</sub>	5 A	
Rated operational current, I <sub>e</sub> utilisation category AC-15	at: 240 V	1 A
Rated operational current, I <sub>e</sub> utilization category DC-13,	at: 24 V	0.3 A
	at: 125 V	0.2 A

### Ratings as per UL, CSA, NEMA

	C300 AC	R300 DC
Rated insulation voltage	250 V	250 V
Rated thermal current	2.5 A	1 A
Rated operational current	at: 120 V 1.5 A at: 125 V 0.75 A at: 240 V 0.75 A at: 250 V 0.11 A	0.22 A

## Short circuit protection

Max. fuse at 1 kA	gG 10A
Make-and-break contacts	

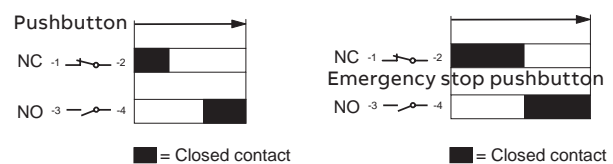

## LEDs (for both compact and modular)

Service life for LED's means number of service hours until the brightness has been reduced down 50 %. Service life 50 000 h	
White LEDs	x=0.31 Y=3.2 means the position of color in the ICI Chromaticity Diagram
Over voltage on LEDs	10 % overvoltage is acceptable without affecting the service life
Voltage peaks on LEDs	Voltage peaks up to 1000 V Current peaks up to 500 mA during a few msec
Gloaming light	All integrated LEDs have a function built in to cut leakage currents

## Mechanical data

### Mechanical life

Pushbuttons, selector switches	500 000 operations
Emergency stop pushbutton	50 000 operations

# Pilot devices

## Compact range

### Order example:

Ex 1: Type CP1-10 ■-10, to order color red replace ■ with R: CP1-10 R-10

Ex 2: Ordering code 1SFA619100R101 □ To order color red replace □ with 1: 1SFA619100R1011 ■

Color codes							
	Red ●	Green ●	Yellow ●	Blue ●	White ○	Black ●	Grey ●
Type ■	R	G	Y	L	W	B	U
Ordering code □	1	2	3	4	5	6	7



Non-illuminated flush Push-button with black plastic bezel

Non-illuminated flush pushbutton				
	Type	Pack size	Ordering code	L.P.(₹)
<b>Momentary</b>				
1 NO	CP1-10 □-10	1 X 10	1SFA619100R101 □	138
2 NO	CP1-10 □-20	1 X 10	1SFA619100R102 □	212
1 NC	CP1-10 □-01	1 X 10	1SFA619100R104 □	138
2 NC	CP1-10 □-02	1 X 10	1SFA619100R105 □	212
1 NO+1 NC	CP1-10 □-11	1 X 10	1SFA619100R107 □	212
<b>Maintained</b>				
1 NO	CP2-10 □-10	1 X 10	1SFA619101R101 □	202
2 NO	CP2-10 □-20	1 X 10	1SFA619101R102 □	234
1 NC	CP2-10 □-01	1 X 10	1SFA619101R104 □	192
2 NC	CP2-10 □-02	1 X 10	1SFA619101R105 □	234
1 NO+1 NC	CP2-10 □-11	1 X 10	1SFA619101R107 □	254



Non-illuminated extended Push-button with black plastic bezel

Non-illuminated extended pushbutton				
	Type	Pack size	Ordering code	L.P.(₹)
<b>Momentary</b>				
1 NO	CP3-10 ■-10	1 X 10	1SFA619102R101 □	159
2 NO	CP3-10 ■-20	1 X 10	1SFA619102R102 □	234
1 NC	CP3-10 ■-01	1 X 10	1SFA619102R104 □	170
2 NC	CP3-10 ■-02	1 X 10	1SFA619102R105 □	234
1 NO+1 NC	CP3-10 ■-11	1 X 10	1SFA619102R107 □	254
<b>Maintained</b>				
1 NO	CP4-10 ■-10	1 X 10	1SFA619103R101 □	202
2 NO	CP4-10 ■-20	1 X 10	1SFA619103R102 □	234
1 NC	CP4-10 ■-01	1 X 10	1SFA619103R104 □	202
2 NC	CP4-10 ■-02	1 X 10	1SFA619103R105 □	244
1 NO+1 NC	CP4-10 ■-11	1 X 10	1SFA619103R107 □	265

# Pilot devices

## Compact range



Pilot light with integrated LED			
Type	Pack size	Ordering code	L.P.(₹)
<b>6.3V,DC</b>			
CL2-506R	1 X 10	1SFA619403R5061 ■	
CL2-506G	1 X 10	1SFA619403R5062 ■	265
CL2-506iY	1 X 10	1SFA619403R5060 ■	
CL2-506L	1 X 10	1SFA619403R5064 ■	550
CL2-506C	1 X 10	1SFA619403R5068 ■	290
CL2-506A	1 X 10	1SFA619403R5069 ■	265
<b>12V, DC</b>			
CL2-501R	1 X 10	1SFA619403R5011 ■	
CL2-501G	1 X 10	1SFA619403R5012 ■	265
CL2-501iY	1 X 10	1SFA619403R5010 ■	
CL2-501L	1 X 10	1SFA619403R5014 ■	550
CL2-501C	1 X 10	1SFA619403R5018 ■	285
CL2-501A	1 X 10	1SFA619403R5019 ■	265
<b>24VAC/DC</b>			
CL2-502R	1 X 10	1SFA619403R5021	
CL2-502G	1 X 10	1SFA619403R5022	244
CL2-502iY	1 X 10	1SFA619403R5020	
CL2-502L	1 X 10	1SFA619403R5024	326
CL2-502C	1 X 10	1SFA619403R5028	244
CL2-502A	1 X 10	1SFA619403R5029	
<b>48-60 VAC/ DC</b>			
CL2-507R	1 X 10	1SFA619403R5071	
CL2-507G	1 X 10	1SFA619403R5072	234
CL2-507iY	1 X 10	1SFA619403R5070	
CL2-507L	1 X 10	1SFA619403R5074	460
CL2-507C	1 X 10	1SFA619403R5078	234
CL2-507A	1 X 10	1SFA619403R5079	
<b>110-130 V, AC</b>			
CL2-513R	1 X 10	1SFA619403R5131	
CL2-513G	1 X 10	1SFA619403R5132	270
CL2-513iY	1 X 10	1SFA619403R5130	
CL2-513L	1 X 10	1SFA619403R5134	530
CL2-513C	1 X 10	1SFA619403R5138	270
CL2-513A	1 X 10	1SFA619403R5139	

<b>110-130 V, DC</b>			
CL2-515R	1 X 10	1SFA619403R5151	
CL2-515G	1 X 10	1SFA619403R5152	265
CL2-515iY	1 X 10	1SFA619403R5150	
CL2-515L	1 X 10	1SFA619403R5154	510
CL2-515C	1 X 10	1SFA619403R5158	265
CL2-515A	1 X 10	1SFA619403R5159	
<b>220 V, DC</b>			
CL2-520R	1 X 10	1SFA619403R5201	
CL2-520G	1 X 10	1SFA619403R5202	265
CL2-520iY	1 X 10	1SFA619403R5200	
CL2-520L	1 X 10	1SFA619403R5204	510
CL2-520C	1 X 10	1SFA619403R5208	265
CL2-520A	1 X 10	1SFA619403R5209	
<b>230 V, AC</b>			
CL2-523R	1 X 10	1SFA619403R5231	
CL2-523G	1 X 10	1SFA619403R5232	265
CL2-523iY	1 X 10	1SFA619403R5230	
CL2-523L	1 X 10	1SFA619403R5234	550
CL2-523C	1 X 10	1SFA619403R5238	265
CL2-523A	1 X 10	1SFA619403R5239	
<b>380 -415 V, AC</b>			
CL2-542R	1 X 10	1SFA619403R5421	
CL2-542G	1 X 10	1SFA619403R5422	275
CL2-542iY	1 X 10	1SFA619403R5420	
CL2-542L	1 X 10	1SFA619403R5424	550
CL2-542C	1 X 10	1SFA619403R5428	275
CL2-542A	1 X 10	1SFA619403R5429	
<b>Rated voltage 230 V AC with 60 V anti-inductive voltage</b>			
CL2-623R	1 X 10	1SFA619403R6231	
CL2-623G	1 X 10	1SFA619403R6232	306
CL2-623iY	1 X 10	1SFA619403R6230	
CL2-623L	1 X 10	1SFA619403R6234	560
CL2-623C	1 X 10	1SFA619403R6238	306

■ Stock items

# Pilot devices

## Compact range



Non-illuminated black selector switch with plastic bezel

Selector switch				
	Type	Pack size	Ordering code	L.P. (₹)
<b>Maintained / Two-positions</b>				
1 NO	C2SS1-10B-10	1 X 10	1SFA619200R1016	360
2 NO	C2SS1-10B-20	1 X 10	1SFA619200R1026	392
1 NC	C2SS1-10B-01	1 X 10	1SFA619200R1046	360
2 NC	C2SS1-10B-02	1 X 10	1SFA619200R1056	392
1 NO+1 NC	C2SS1-10B-11	1 X 10	1SFA619200R1076	
<b>Maintained / Two-positions</b>				
1 NO	C2SS2-10B-10	1 X 10	1SFA619201R1016	360
2 NO	C2SS2-10B-20	1 X 10	1SFA619201R1026	392
1 NC	C2SS2-10B-01	1 X 10	1SFA619201R1046	360
2 NC	C2SS2-10B-02	1 X 10	1SFA619201R1056	392
1 NO+1 NC	C2SS2-10B-11	1 X 10	1SFA619201R1076	
<b>Momentary / Two-positions</b>				
1 NO	C2SS3-10B-10	1 X 10	1SFA619202R1016	340
2 NO	C2SS3-10B-20	1 X 10	1SFA619202R1026	392
1 NC	C2SS3-10B-01	1 X 10	1SFA619202R1046	340
2 NC	C2SS3-10B-02	1 X 10	1SFA619202R1056	392
1 NO+1 NC	C2SS3-10B-11	1 X 10	1SFA619202R1076	
<b>Maintained / Three-positions</b>				
2 NO	C3SS1-10B-20	1 X 10	1SFA619210R1026	392
2 NC	C3SS1-10B-02	1 X 10	1SFA619210R1056	392
1 NO+1 NC	C3SS1-10B-11	1 X 10	1SFA619210R1076	
<b>Momentary / Three-positions</b>				
2 NO	C3SS2-10B-20	1 X 10	1SFA619211R1026	392
2 NC	C3SS2-10B-02	1 X 10	1SFA619211R1056	392
1 NO+1 NC	C3SS2-10B-11	1 X 10	1SFA619211R1076	
<b>Momentary / Three-positions</b>				
2 NO	C3SS3-10B-20	1 X 10	1SFA619212R1026	392
2 NC	C3SS3-10B-02	1 X 10	1SFA619212R1056	392
1 NO+1 NC	C3SS3-10B-11	1 X 10	1SFA619212R1076	



Non-illuminated emergency stop pushbutton, 30 mm



Non-illuminated emergency stop pushbutton, 40 mm

Emergency stop pushbutton				
Description	Type	Pack size	Ordering code	L.P.(₹)
<b>•</b>				
Twist release				
1 NC	∅ 30 mm CE3T-10R-01	1	1SFA619500R1041 ■	260
2 NC	∅ 30 mm CE3T-10R-02	1	1SFA619500R1051	330
1NO+1NC	∅ 30 mm CE3T-10R-11	1	1SFA619500R1071	318
Pull release				
2 NC	∅ 30 mm CE3P-10R-02	1	1SFA619501R1051	318
1NO+1NC	∅ 30 mm CE3P-10R-11	1	1SFA619501R1071	376
Key release: Ronis 455, key code 71				
2 NC	∅ 30 mm CE3K1-10R-02	1	1SFA619502R1051	975
1NO+1NC	∅ 30 mm CE3K1-10R-11	1	1SFA619502R1071	
Twist release				
1 NC	∅ 40 mm CE4T-10R-01	1	1SFA619550R1041 ■	270
2 NC	∅ 40 mm CE4T-10R-02	1	1SFA619550R1051 ■	342
1NO+1NC	∅ 40 mm CE4T-10R-11	1	1SFA619550R1071 ■	
Pull release				
2 NC	∅ 40 mm CE4P-10R-02	1	1SFA619551R1051 ■	342
1NO+1NC	∅ 40 mm CE4P-10R-11	1	1SFA619551R1071	
Key release: Ronis 455, key code 71				
2 NC	∅ 40 mm CE4K1-10R-02	1	1SFA619552R1051	1,050
1NO+1NC	∅ 40 mm CE4K1-10R-11	1	1SFA619552R1071	

# Pilot devices

## Compact range



Non-illuminated machine stop pushbutton, pull release, 30 mm



Non-illuminated machine stop pushbutton, push release, 30 mm

Machine stop					
Description	Type	Pack size	Ordering code	L.P.(₹)	
•	Twist release				
1NO+1NC Ø 30 mm	CE3T-10B-11	1	1SFA619500R1076	318	
	Pull release				
1NO+1NC Ø 30 mm	CE3P-10B-11	1	1SFA619501R1076	742	
	Key release: Ronis 455, Key code 71				
1NO+1NC Ø 30 mm	CE3K1-10B-11	1	1SFA619502R1076	1,040	
	Twist release				
1NO+1NC Ø 40 mm	CE4T-10B-11	1	1SFA619550R1076	318	
	Pull release				
1NO+1NC Ø 40 mm	CE4P-10B-11	1	1SFA619551R1076	742	
	Key release: Ronis 455, Key code 71				
1NO+1NC Ø 40 mm	CE4K1-10B-11	1	1SFA619552R1076	1,040	

Buzzer						
Description	Sound output	Rated current mA	Type	Pack size	Ordering code	L.P.(₹)
Rated voltage 24 V, AC/DC						
● Black	Continuous	40	CB1-620B	1	1SFA619600R6206	1,490
● Black	Pulsation	48	CB1-630B	1	1SFA619600R6306	
Rated voltage 230 V, AC						
● Black	Continuous	40	CB1-623B	1	1SFA619600R6236	1,490
● Black	Pulsation	40	CB1-633B	1	1SFA619600R6336	
Rated voltage 110-130 V, DC						
● Black	Continuous	15	CB1-622B	1	1SFA619600R6226	1,490
● Black	Pulsation	15	CB1-632B	1	1SFA619600R6326	
Rated voltage 110-130 V, AC						
● Black	Continuous	40	CB1-621B	1	1SFA619600R6216	1,490
● Black	Pulsation	45	CB1-631B	1	1SFA619600R6316	



Assembled compact emergency stop enclosures					
Description	Type	Pack size	Ordering code	L.P.(₹)	
<b>1-seat plastic enclosure (yellow)</b>					
■ □ Twist release. Red button 2 NC	CEPY1-1001	1	1SFA619821R1001	4,410	
■ □ Pull release. Red button 2 NC	CEPY1-1002	1	1SFA619821R1002		
<b>Emergency stop enclosure with shroud</b>					
■ □ Twist release. Red button 2 NC	CEPY1-2002	1	1SFA619821R2002	4,696	
■ □ Pull release. Red button 2 NC	CEPY1-2001	1	1SFA619821R2001		
<b>1-seat plastic enclosure with black mushroom pushbutton (dark grey)</b>					
■ □ Twist release. Black button 1 NO + 1 NC	CEP1-1001	1	1SFA619811R1001	3,710	
■ □ Pull release. Black button 1 NO + 1 NC	CEP1-1002	1	1SFA619811R1002	2,068	
<b>Machine stop enclosure with shroud</b>					
■ □ Twist release. Black button 1 NO + 1 NC	CEP1-2001	1	1SFA619811R2001	4,060	
■ □ Pull release. Black button 1 NO + 1 NC	CEP1-2002	1	1SFA619811R2002	2,428	



# Pilot devices

## Technical data modular range

Standard and approvals	
IEC / EN 60947-1	Low-voltage switchgear and controlgear - Part 1: General rules
IEC / EN 60947-5-1	Low-voltage switchgear and controlgear - Part 5-1: Control circuit devices and switching elements - Electromechanical control circuit devices
IEC / EN 60947-5-5	Low-voltage switchgear and controlgear - Part 5-5: Control circuit devices and switching elements - Electrical emergency stop device with mechanical latching function
IEC / EN 60073	Basic and safety principles for man-machine interface, marking and identification - Coding principles for indicators and actuators
IEC / EN 60529	Degrees of protection provided by enclosures (IP Code)
EN 50013	Low-voltage switchgear and controlgear for industrial use - Terminal marking and distinctive number for particular control switches
UL 508	Industrial control equipment
CSA C22.2 No 14	Industrial control equipment

Environmental data		
Degrees of protection		
Operators	IEC/EN	UL/CSA
Pushbutton	IP 66	Type 1, 3R, 4, 4X, 12, 13
Double pushbutton	IP 66	Type 1, 3R, 4, 4X, 12, 13
Mushroom	IP 66	Type 1, 3R, 4, 4X, 12, 13
Emergency stop	IP 66	Type 1, 3R, 4, 4X, 12, 13
Selector switch	IP 66	Type 1, 3R, 4, 4X, 12, 13
Key operated selector switch	IP 66	Type 1, 3R, 4, 4X, 12
Toggle switch	IP 66	Type 1, 3R, 4, 4X, 12, 13
Extreme duty pushbutton	-	Type 1, 3R, 4, 4X
Reset button	IP 66	Type 1, 3R, 4, 4X, 12, 13
Joystick	IP 66, 67, 69K	Type 1, 4X (indoor), 12, 13
Pilot lights	IP 66	Type 1, 3R, 4, 4X, 12, 13
Buzzer	IP 65	Type 4X
Potentiometer	IP 66	Type 1, 3R, 4, 4X, 12, 13
Contact block and transformer block	IP 20	-
Plastic enclosures	IP 66	Type 1, 3R, 4, 4X, 12, 13
Metallic enclosures	IP 66, 67, 69K	-

Temperature	
Ambient temperature during operation	-25 to +70 °C
Storage temperature	-40 to +85 °C

Technical data	
Terminals	
Plus-minus Pozidriv No.2 screw with DIN-washer	
Connectable area	min. 1 x 0.5 mm <sup>2</sup> AWG 20 max. 2 x 2.5 mm <sup>2</sup> /2 x AWG14

Tightening torque	
Operators, M22	Min. 2 Nm / Max. 2.3 Nm
Cable terminals	0.9 Nm
Recommended maximum number of blocks: 6	

Electrical data	
Standards contact blocks	
Mechanical endurance	10 million operations
Self cleaning contacts of silver, NC contact with positive opening. At voltages and currents below 24 V and 5.6 mA we recommended our micro switch blocks or as an alternative, gold plated contacts.	

Ratings as per IEC 60947-5-1		
Rated insulation voltage, U <sub>i</sub>	690 V	
Rated thermal current, I <sub>th</sub>	10 A	
Rated operational current, I <sub>e</sub> utilisation category AC 15,	at: 120 V	8 A
	at: 230 V	6 A
	at: 400 V	4 A
	at: 690 V	2 A
Rated operational current, I <sub>e</sub> utilisation category DC 13,	at: 24 V	5 A
	at: 125 V	1.1 A
	at: 250 V	0.55 A

Ratings as per UL, CSA, NEMA		A600 AC	Q600 DC
Rated insulation voltage		600 V	600 V
Rated thermal current		10 A	2.5 A
Rated operational current	at: 120 V	6 A	at: 125 V 0.55 A
	at: 240 V	3 A	at: 250 V 0.27 A
	at: 480 V	1.5 A	at: 480 V 0.10 A
	at: 600 V	1.2 A	at: 600 V 0.10 A

Contact resistance	< 25 mΩ
Compulsory function test	at: 5V, 16 mA

Micro switch block / ratings as per IEC 60947-5-1		
Rated insulation voltage, U <sub>i</sub>	125 V	
Rated thermal current, I <sub>th</sub>	3 A	
Rated operational current, I <sub>e</sub> utilisation category AC 14,	at: 125 V	0.5 A
Rated operational current, I <sub>e</sub> utilization category DC 13,	at: 24 V	0.3 A
Rated operational current, I <sub>e</sub> utilization category DC 12,	at: 24 V	0.1 A
Minimum switching capacity	3 V DC	1 mA

Ratings as per UL 508		
	125 V AC	3 A
	60 V DC	0.2 A
	48 V DC	0.1 A

Short circuit protection	
Max. fuse at 1 kA	gG 16A
Note: LEDs see technical data compact range	

Mechanical data	
Mechanical life	
Pushbuttons, momentary mushroom	2 million operations
Selector switches. Present standard (no operation of center contact)	500 000 operations
With operation of center contact	250 000 operations
	150 000 operations
Maintained mushroom, pushbutton, key operated selector switch and double pushbutton	500 000 operations
Emergency stop	100 000 operations
Toggle switch	1 million operations

# Pilot devices

## Modular range



### Modular product features

- Widest range of integrated LEDs on the market
- Parts of Range IP 66, 67, 69K
- All range & UL Type 1, 3R, 4, 4X, 12, 13
- Snap-on feature reduces installation time
- Quick release contact holder
- Several bezel colors
- Unique low energy solutions, including wiping action

### How to order standard operators:

- Non-illuminated operator + holder
- + contact block(s)
- Illuminated operator + holder
- + contact block(s)
- + lamp block

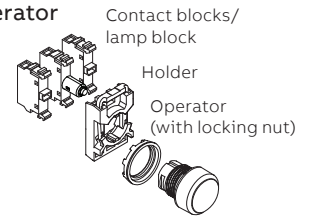

\*Only for illuminated operator

### How to order Bezel:

Bezel options	Type	Ordering code
Black plastic	MPX-10X	1SFA611 10X R1XXX

### Color codes

	Red ●	Green ●	Yellow ●	Blue ●	White ○	Black ●	Grey ●
Type ■	R	G	Y	L	W	B	U
Ordering code □	1	2	3	4	5	6	7

### Ordering example:

Ex 1: Type MP1-10 ■, to order color red replace ■ with R: MP1-10R

Ex 2: Ordering code 1SFA611100R1001 n, to order color red replace □ with 1: 1SFA619100R1001

### Operator : Flush button Non-illuminated push button

	Type	Pack size	Ordering code	L.P. (₹)
Momentary	MP1-10 ■	1 X 10	1SFA611100R100 □	72
Maintained	MP2-10 ■	1 X 10	1SFA611101R100 □	108

### Operator : Extended button Non-illuminated push button

Momentary	MP3-10 ■	1 X 10	1SFA611102R100 □	106
Maintained	MP4-10 ■	1 X 10	1SFA611103R100 □	106

### Color codes

	Red ●	Green ●	Yellow ●	Blue ●	White ○	Black ●	Grey ●	Amber ●
Type ■	R	G	Y	L	W	B	U	AN
Ordering code □	1	2	3	4	5	6	7	9

	Type	Pack size	Ordering code	L.P. (₹)
--	------	-----------	---------------	----------

### Operator : Flush button illuminated push button

Momentary	MP1-11 ■	1 X 10	1SFA611100R110 □	102
	MP1-11AN	1 X 10	1SIN611100R1109	102
Maintained	MP2-11 ■	1 X 10	1SFA611101R110 □	126
	MP2-11AN	1 X 10	1SIN611101R1109	

### Operator : Extended button illuminated push button

Momentary	MP3-11 ■	1 X 10	1SFA611102R110 □	
	MP3-11AN	1 X 10	1SIN611102R1109	
Maintained	MP4-11 ■	1 X 10	1SFA611103R110 □	126
	MP4-11AN	1 X 10	1SIN611103R1109	

Note:

1. Integrated LED block to be considered from MLBL range of suitable voltage from page no. 109

### Separate holder

Holders for three blocks	MCBH-00	1 X 10	1SFA611605R1100	34
Contact blocks only (without holder)				
1 NO	MCB-10	1 X 10	1SFA611610R1001 ■	80
1 NC	MCB-01	1 X 10	1SFA611610R1010 ■	80

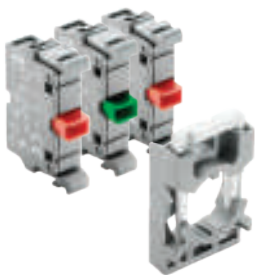

Blocks and holder

■ Stock items

# Pilot devices

## Modular range



LED lamp block with built in leakage curragge protection

Operator : Pilot lights				
	Type	Pack size	Ordering code	L.P.(₹)
● Red	ML1-100R	1 X 10	1SFA611400R1001 ■	83
● Green	ML1-100G	1 X 10	1SFA611400R1002 ■	
● Yellow	ML1-100Y	1 X 10	1SFA611400R1003 ■	
● Blue	ML1-100L	1 X 10	1SFA611400R1004	
○ White	ML1-100W	1 X 10	1SFA611400R1005	
● Amber	ML1-100AN	1 X 10	1SIN611400R1009	
Separate holder				
	Type	Pack size	Ordering code	L.P.(₹)
Holdings for three blocks	MCBH-00	1 X 10	1SFA611605R1100 ■	34
Lamp blocks with integrated LED				
Rated voltage 24 V, AC/DC				
	Type	Pack size	Ordering code	L.P.(₹)
● Red	MLBL-01R	1 X 10	1SFA611621R1011 ■	180
● Green	MLBL-01G	1 X 10	1SFA611621R1012 ■	
● Yellow	MLBL-01YN	1 X 10	1SIN611621R1013	414
● Blue	MLBL-01L	1 X 10	1SFA611621R1014 ■	
○ White	MLBL-01W	1 X 10	1SFA611621R1015 ■	192
● Amber	MLBL-01A	1 X 10	1SFA611621R1016	
Rated voltage 110-130 V, AC				
	Type	Pack size	Ordering code	L.P.(₹)
● Red	MLBL-04R	1 X 10	1SFA611621R1041	180
● Green	MLBL-04G	1 X 10	1SFA611621R1042	
● Yellow	MLBL-04YN	1 X 10	1SIN611621R1043	392
● Blue	MLBL-04L	1 X 10	1SFA611621R1044	
○ White	MLBL-04W	1 X 10	1SFA611621R1045	192
● Amber	MLBL-04A	1 X 10	1SFA611621R1046	
Rated voltage 110-130 V, DC				
	Type	Pack size	Ordering code	L.P.(₹)
● Red	MLBL-05R	1 X 10	1SFA611621R1051	180
● Green	MLBL-05G	1 X 10	1SFA611621R1052	
● Yellow	MLBL-05YN	1 X 10	1SIN611621R1053	414
● Blue	MLBL-05L	1 X 10	1SFA611621R1054	
○ White	MLBL-05W	1 X 10	1SFA611621R1055	192
● Amber	MLBL-05A	1 X 10	1SFA611621R1056	
Rated voltage 220 V, DC				
	Type	Pack size	Ordering code	L.P.(₹)
● Red	MLBL-06R	1 X 10	1SFA611621R1061	180
● Green	MLBL-06G	1 X 10	1SFA611621R1062	
● Yellow	MLBL-06YN	1 X 10	1SIN611621R1063	404
● Blue	MLBL-06L	1 X 10	1SFA611621R1064	
○ White	MLBL-06W	1 X 10	1SFA611621R1065	180
● Amber	MLBL-06A	1 X 10	1SFA611621R1066	
Rated voltage 230 V, AC				
	Type	Pack size	Ordering code	L.P.(₹)
● Red	MLBL-07R	1 X 10	1SFA611621R1071	180
● Green	MLBL-07G	1 X 10	1SFA611621R1072 ■	
● Yellow	MLBL-07YN	1 X 10	1SIN611621R1073	404
● Blue	MLBL-07L	1 X 10	1SFA611621R1074 ■	
○ White	MLBL-07W	1 X 10	1SFA611621R1075	180
● Amber	MLBL-07A	1 X 10	1SFA611621R1076	

Note: 48 V AC/DC, 60 V AC/DC, 380 V AC and 415 V AC L.P.(₹)S will be available upon request

■ Stock items



# Pilot devices

## Modular range



Operator : Emergency stop pushbutton				
	Type	Pack size	Ordering code	L.P.(₹)
●	Ø 30 mm / Non-illuminated			
Twist release	MPET3-10R	1	1SFA611520R1001	488
Pull release	MPEP3-10R	1	1SFA611521R1001	
Key release code 71/Ronis 455	MPEK3-11R	1	1SFA611522R1101	
Key release code 72/ Ronis 421	MPEK3-12R	1	1SFA611522R1201	934
Key release code 73/ Ronis 3433-E	MPEK3-13R	1	1SFA611522R1301	
	Ø 40 mm / Non-illuminated			
Twist release	MPET4-10R	1	1SFA611523R1001	424
Pull release	MPEP4-10R	1	1SFA611524R1001	890
Key release code 71/Ronis 455	MPEK4-11R	1	1SFA611525R1101	912
Key release code 72/ Ronis 421	MPEK4-12R	1	1SFA611525R1201	
Key release code 73/ Ronis 3433-E	MPEK4-13R	1	1SFA611525R1301	
	Ø 60 mm / Non-illuminated			
Twist release	MPMT4-10R	1	1SFA611513R1001	754
Pull release	MPMP4-10R	1	1SFA611514R1001	616
	Ø 40 mm / Illuminated			
Twist release	MPMT3-11R	1	1SFA611510R1101 ■	722
Pull release	MPMP3-11R	1	1SFA611511R1101	584
	Ø 60 mm / Illuminated			
Twist release	MPMT4-11R	1	1SFA611513R1101	986
Pull release	MPMP4-11R		1SFA611514R1101	784

Refer holder and contact block configuration for standard operator from page no. 110



Operator : Machine stop pushbutton				
	Type	Pack size	Ordering code	L.P.(₹)
●	Ø 30 mm			
Twist release	MPET3-10B	1	1SFA611520R1006	498
Pull release	MPEP3-10B	1	1SFA611521R1006	
Key release	MPEK3-10B	1	1SFA611522R1106	
	Ø 40 mm			
Twist release	MPET4-10B	1	1SFA611523R1006	498
Pull release	MPEP4-10B	1	1SFA611524R1006	

Refer holder and contact block configuration for standard operator from page no. 110



Operator : Double pushbutton				
	Type	Pack size	Ordering code	L.P.(₹)
● Upper ● Lower	Extended lower button / Non-illuminated			
I / O	MPD13-11B	1	1SFA611142R1106	520
START / STOP	MPD15-11B	1	1SFA611144R1106	
● Upper ● Lower	Extended lower button / Illuminated			
I / O	MPD13-11C	1	1SFA611142R1108	774
START / STOP	MPD15-11C	1	1SFA611144R1108	
● Upper ● Lower	○ Upper Extended lower button / ● Lower Non-illuminated			
I / O	MPD17-11B	1	1SFA611146R1106	520

Refer holder and contact block configuration for standard operator

# Pilot devices

## Modular range



### Operator: non-illuminated black two-position selector switch

Type	Pack size	Ordering code	L.P.(₹)
<b>Maintained / Short handle</b>			
M2SS1-10B	1	1SFA611200R1006	340
<b>Maintained / Short handle</b>			
M2SS2-10B	1	1SFA611201R1006	340
<b>Momentary / Short handle, spring return from C to B</b>			
M2SS3-10B	1	1SFA611202R1006	350
<b>Maintained / Long handle</b>			
M2SS4-10B	1	1SFA611203R1006	1,018
<b>Maintained / Long handle</b>			
M2SS5-10B	1	1SFA611204R1006	1,018
<b>Momentary / Long handle, spring return from C to B</b>			
M2SS6-10B	1	1SFA611205R1006	1,040

Refer holder and contact block configuration for standard operator

### Operator: non-illuminated black three-position selector switch

Type	Pack size	Ordering code	L.P.(₹)
<b>Maintained / Short handle</b>			
M3SS1-10B	1	1SFA611210R1006	340
<b>Momentary / Short handle, spring return from A to B and C to B</b>			
M3SS2-10B	1	1SFA611211R1006	350
<b>Momentary / Short handle, spring return from C to B</b>			
M3SS3-10B	1	1SFA611212R1006	350
<b>Momentary / Short handle, spring return from A to B</b>			
M2SS7-10B	1	1SFA611216R1006	350
<b>Maintained / Long handle</b>			
M3SS4-10B	1	1SFA611213R1006	1,018
<b>Momentary / Long handle, spring return from A to B and C to B</b>			
M3SS5-10B	1	1SFA611214R1006	1,040
<b>Momentary / Long handle, spring return from C to B</b>			
M3SS6-10B	1	1SFA611215R1006	1,304
<b>Momentary / Long handle, spring return from A to B</b>			
M2SS8-10B	1	1SFA611217R1006	954

Refer holder and contact block configuration for standard operator

### Operator: non-illuminated black three-position selector switch with operation of center position

Type	Pack size	Ordering code	L.P.(₹)
<b>Short handle</b>			
M3SSC1-10B	1	1SFA611250R1006	372
M3SSC2-10B	1	1SFA611251R1006	
M3SSC3-10B	1	1SFA611252R1006	
M3SSC7-10B	1	1SFA611256R1006	
<b>Long handle</b>			
M3SSC4-10B	1	1SFA611253R1006	1,072
M3SSC5-10B	1	1SFA611254R1006	
M3SSC6-10B	1	1SFA611255R1006	

Refer holder and contact block configuration for standard operator

# Pilot devices

## Modular range



Operator : Key operated selector switch					
	Type		Pack size	Ordering code	L.P.(₹)
●	Maintained / Two positions (The key can be removed in both position)				
71/Ronis 455	M2SSK1-101		1	1SFA611280R1001	784
72/Ronis 421	M2SSK1-102		1	1SFA611280R1002	
73/Ronis 3433-E	M2SSK1-103		1	1SFA611280R1003	
Random selection*)	M2SSK1-104		1	1SFA611280R1004	
	Maintained / Two positions (The key can be removed in position B only)				
71/Ronis 455	M2SSK2-101		1	1SFA611281R1001	784
72/Ronis 421	M2SSK2-102		1	1SFA611281R1002	
73/Ronis 3433-E	M2SSK2-103		1	1SFA611281R1003	
Random selection*)	M2SSK2-104		1	1SFA611281R1004	
	Momentary / Two positions, spring return from C to B (The key can be removed in position B only)				
71/Ronis 455	M2SSK3-101		1	1SFA611282R1001	870
72/Ronis 421	M2SSK3-102		1	1SFA611282R1002	
73/Ronis 3433-E	M2SSK3-103		1	1SFA611282R1003	
Random selection*)	M2SSK3-104		1	1SFA611282R1004	

Refer holder and contact block configuration for standard operator

Operator : Key operated selector switch					
	Type		Pack size	Ordering code	L.P.(₹)
●	Maintained / Three positions (The key can be removed in both position)				
71/Ronis 455	M3SSK1-101		1	1SFA611283R1001	795
72/Ronis 421	M3SSK1-102		1	1SFA611283R1002	
73/Ronis 3433-E	M3SSK1-103		1	1SFA611283R1003	
Random selection*)	M3SSK1-104		1	1SFA611280R1004	
	Maintained / Three positions (The key can be removed in position B only)				
71/Ronis 455	M3SSK2-101		1	1SFA611284R1001	795
72/Ronis 421	M3SSK2-102		1	1SFA611284R1002	
73/Ronis 3433-E	M3SSK2-103		1	1SFA611284R1003	
Random selection*)	M3SSK2-104		1	1SFA611284R1004	
	Momentary / Three positions, spring return from C to B (The key can be removed in position B only)				
71/Ronis 455	M3SSK3-101		1	1SFA611285R1001	870
72/Ronis 421	M3SSK3-102		1	1SFA611285R1002	
73/Ronis 3433-E	M3SSK3-103		1	1SFA611285R1003	
Random selection*)	M3SSK3-104		1	1SFA611285R1004	

Refer holder and contact block configuration for standard operator

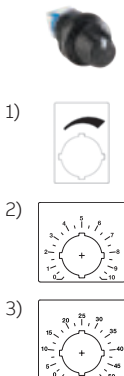

Potentiometer					
	Type		Pack size	Ordering code	L.P.(₹)
●	with resistor 5 kohm				
Black plastic	MT-105B		1	1SFA611410R1056	4,188
●	with resistor 10 kohm				
Black plastic	MT-110B		1	1SFA611410R1106	4,188
●	with resistor 50 kohm				
Black plastic	MT-150B		1	1SFA611410R1506	4,718

Toggle switch*					
	Type		Pack size	Ordering code	L.P.(₹)
●	Maintained / Two-positions				
Black plastic	MTS1-10B		1	1SFA611300R1006	742
●	Momentary / Three-positions				
Black plastic	MTS2-10B		1	1SFA611301R1006	964
●	Maintained / Three-positions				
Black plastic	MTS3-10B		1	1SFA611302R1006	742

# Pilot devices

## Modular range

• Joystick (holder included)  
+ contact blocks

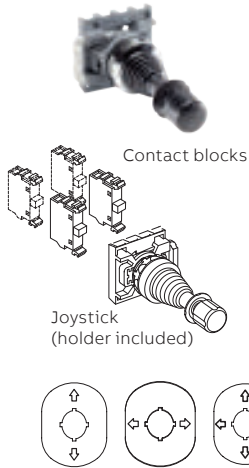

Joystick				
●	Type	Pack size	Ordering code	L.P.(₹)
<b>Maintained</b>				
2 - position	MJS1-60B	1	1SFA611701R6006	4,018
4 - position	MJS5-60B	1	1SFA611705R6006	4,410
<b>Spring return</b>				
2 - position	MJS2-60B	1	1SFA611702R6006	4,018
4 - position	MJS6-60B	1	1SFA611706R6006	4,410
<b>Maintained / Latching function</b>				
2 - position	MJS7-60B	1	1SFA611707R6006	4,410
4 - position	MJS11-60B	1	1SFA611711R6006	5,100
<b>Spring return / Latching function</b>				
2 - position	MJS8-60B	1	1SFA611708R6006	4,410
4 - position	MJS12-60B	1	1SFA611712R6006	5,100

Legend plates for joystick				
2 - position	MA6-1240	1	1SFA611930R1240	
2 - position	MA6-1241	1	1SFA611930R1241	350
4 - position	MA6-1242	1	1SFA611930R1242	

Refer holder and contact block configuration for standard operator

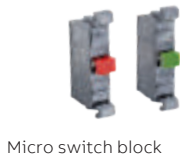

Micro switch blocks				
Description	Type	Pack size	Ordering code	L.P.(₹)
1 NO	MCBL-10	1	1SFA611612R1010	
1 NC	MCBL-01	1	1SFA611612R1001	625

Extreme duty pushbutton				
● ● ●	Type	Pack size	Ordering code	L.P.(₹)
For Ø 30 mm mounting hole				
● ● ●	KP6-40 ■	1	1SFA616105R400 □	1,718

Refer contact block configuration for standard operator



Reset pushbutton				
● ○	Type	Pack size	Ordering code	L.P.(₹)
<b>With shaft</b>				
No text	KPR3-100 ■	1	1SFA616162R100 □	530
<b>Without shaft</b>				
No text	KPR1-100 ■	1	1SFA616160R100 □	403
<b>Accessories: Shaft (black)</b>				
No text	KA1-8046	1	1SFA616920R8046	170

Accessories				
	Type	Pack size	Ordering code	L.P.(₹)
Mounting tool	MA1-8015	1	1SFA611920R8015	372
Membrane of silicone flush button	KA1-8052	1	1SFA611920R8052	240
Membrane of silicone extended button	KA1-8002	1	1SFA611920R8002	440
Locking nut	MA1-8019	1	1SFA611920R8019	282

\*Spacer is needed when legendplates are not used in plastic enclosures

# Pilot devices

## Enclosures



Empty enclosures



Shroud



DIN-rail adaptor

### Empty plastic enclosures for modular and compact range

Description	Type	Pack size	Ordering code	L.P.(₹)
■ □ 1-seat	MEPY1-0	1	1SFA611821R1000	2,132
■ □ 1-seat	MEP1-0	1	1SFA611811R1000	2,100
■ □ 2-seat	MEP2-0	1	1SFA611812R1000	1,940
■ □ 3-seat	MEP3-0	1	1SFA611813R1000	2,736
■ □ 4-seat	MEP4-0	1	1SFA611814R1000	3,710
■ □ 6-seat	MEP6-0	1	1SFA611816R1000	5,650

### Shroud for modular range push button operator

■ Yellow	MA1-8053	1	1SFA611920R8053	616
■ Grey	MA1-8128	1	1SFA611920R8128	1,802

### Empty enclosures for compact range

■ □ Yellow/Light grey	CEPY1-0	1	1SFA619821R1000	1,814
■ □ Dark grey/Light grey	CEP1-0	1	1SFA619811R1000	1,484

### Shroud for compact range push buttons

■ Yellow	CA1-8053	1	1SFA619920R8053	392
■ Grey	CA1-8054	1	1SFA619920R8054	392

### DIN-rail adaptor

DIN-rail adaptor	MA1-8131	1	1SFA611920R8131	1,080
------------------	----------	---	-----------------	-------

## Signal towers and signal beacons\*



\* Price on request

# Signal tower and beacons



KL70-401B

1SFC151507F0001



KL70-401Y

SFC151508F0001

Description					
Colors	Red	Green	Yellow	Blue	Clear
Replace ■ in type with	R	G	Y	B	C
Replace □ in Ordering code with	1	2	3	4	8

Description	Type	Ordering code	L.P.(₹)
<b>Light element</b>			
<b>Available in red, green, yellow, blue and clear</b>			
Permanent light, 12-240 V AC/DC For bulb BA 15d. Bulb not included	KL70-401 ■	1SFA616070R401 □	2,184
Blinking light, 24 V AC/DC with integrated LED	KL70-306 ■	1SFA616070R306 □	9,096
Flashing light, 24 V AC/DC with integrated xenon tube	KL70-203 ■	1SFA616070R203 □	12,594
Blinking light, 115 V AC with integrated LED	KL70-342 ■	1SFA616070R342 □	8,184
Flashing light, 115 V AC with integrated xenon tube	KL70-113 ■	1SFA616070R113 □	10,208
Blinking light, 230 V AC with integrated LED	KL70-352 ■	1SFA616070R352 □	9,096
Flashing light, 230 V AC with integrated xenon tube	KL70-123 ■	1SFA616070R123 □	9,774
LED permanent light, 24 V AC/DC with integrated LED	KL70-305 ■	1SFA616070R305 □	8,554
LED rotating light, 24 V AC/DC with integrated LED	KL70-307 ■	1SFA616070R307 □	19,208

<b>LED bulbs Ba 15d, 40mA</b>			
<b>Available in red, green, yellow, blue and white</b>			
24 V AC/DC	KA4-102 ■	1SFA616924R102 □	5,354

<b>Audible modules buzzer element. 85 dB, continuous or pulsating tone, adjustable</b>			
24 V AC/DC	KB70-3001	1SFA616071R3001	5,608
115 V AC	KB70-3101	1SFA616071R3101	6,414
115 V AC	KB70-1201	1SFA616071R1201	5,958



# Signal towers



KT70-10...

1SFC151510F0001



KA70-1001

1SFC151511F0001



KA70-1034

1SFC151512F0001

Description	Type	Ordering code	L.P.(₹)
<b>Siren element</b>			
Multi function, 8 diff. Tones adjustable, volume adjustable 100 dB, 115 V AC	KS70-1104	1SFA616073R1104	9,392
Multi function, 8 diff. Tones adjustable, volume adjustable 100 dB, 230 V AC	KS70-1204	1SFA616073R1204	9,392
Multi function, 7 diff. Tones adjustable, volume adjustable, 100 dB, 24 V DC	KS70-2004	1SFA616073R2004	10,294
Multi function, 8 diff. Tones adjustable, volume adjustable 100 dB, 24 V AC/DC	KS70-3004	1SFA616073R3004	7,930
Continuous tone alternating 108 dB, 24 V DC	KS70-2002	1SFA616073R2002	6,095
<b>Terminal elements</b>			
For tube mounting, including cap	KT70-1001	1SFA616075R1001	3,212
For bracket or base, including cap	KT70-1002	1SFA616075R1002	3,212
<b>Special parts</b>			
<b>Contact box</b>			
Cable exit at side	KA70-1001	1SFA616077R1001	678
Magnetic base	KA70-1002	1SFA616077R1002	4,176
<b>Base with tube</b>			
D=25 mm L=110 mm	KA70-1011	1SFA616077R1011	1,708
<b>Base for tube</b>			
D=25 mm, plastic	KA70-1012	1SFA616077R1012	828
D=25 mm, metal	KA70-1013	1SFA616077R1013	2,556
<b>Tube, anodized aluminum</b>			
D=25 mm L=250 mm	KA70-1021	1SFA616077R1021	1,378
D=25 mm L=400 mm	KA70-1022	1SFA616077R1022	1,643
D=25 mm L=800 mm	KA70-1023	1SFA616077R1023	3,286
<b>Bracket</b>			
1-sided mounting	KA70-1031	1SFA616077R1031	1,198
2-sided mounting	KA70-1032	1SFA616077R1032	1,198
For tube mounting	KA70-1033	1SFA616077R1033	1,262
For surface mounting	KA70-1034	1SFA616077R1034	1,262

# Signal beacons



KSB-401G

SFC151513F0001



KASB-100

SFC151514F0001

Description					
Colors	● Red	● Green	● Yellow	● Blue	○ Clear
Replace ■ in type with	R	G	Y	B	C
Replace □ in Ordering code with	1	2	3	4	8
Light element: Available in red, green, yellow, blue and clear					
Permanent light, 12-240 V AC/DC. For Bulb BA 15dBulb not included	KSB-401 ■	1SFA616080R401 □			13,908
Flashing light, 24 V DC. With integrated xenon tube	KSB-203 ■	1SFA616080R203 □			13,972
Flashing light, 115 V AC. With integrated xenon tube	KSB-113 ■	1SFA616080R113 □			11,904
Flashing light, 230 V AC. With integrated xenon tube	KSB-123 ■	1SFA616080R123 □			11,904
Light element LED: Available in red, green and yellow					
LED permanent light, 24 V AC/DC. With integrated LED	KSB-305 ■	1SFA616080R305 □			15,412
LED blinking light, 24 V AC/DC. With integrated LED	KSB-306 ■	1SFA616080R306 □			15,412
LED rotation light, 24 V AC/DC. With integrated LED	KSB-307 ■	1SFA616080R307 □			13,908
Special parts					
Anti-twist device	KASB-100	1SFA616087R1000			530



# Electronic products and relays

## The product range



### Time relays, CT range

Three ranges of electronic timers provide timing functions for all applications: the CT-D range with a width of just 17.5 mm; the CT-C range, the ideal solution for serial applications; and the CT-S range that has two different types of connection terminals and is ideally suited for universal use. The CT range has a wide variety of timing functions (from ON or OFF delay to star-delta changeover). The time relays are available with output relays, solid-state outputs and precise direct time adjustment.



### Measuring and monitoring relays, CM range

State-of-the-art monitors for single and three-phase systems. Monitoring of: voltage, current, frequency, power factor (motor load), thermistors, temperature, liquid level, insulation resistance, and grid feeding. ABB has one of the world's widest product ranges of measuring and monitoring relays. The CM range is a key product line of the EPR range.



### Power supplies, CP range

Modern power supply units are a vital component in most areas of energy management and automation technology. As your global partner in this area, ABB pays close attention to corresponding requirements. Innovation is the key to the substantial enlargement of our power supply product range. ABB offers four different product lines for single and three-phase supplies, output voltages 5/12/24, and 48 VDC in plastic and metal enclosure, as well as various accessories.



### Interface relays and optocouplers, CR range and R600

Interface relays and optocouplers are widely used in various industrial applications. As an interface, they link the controller, e.g. PLC (programmable logic controller), PC or field bus systems to the sensor/actuator level. Here, they have various functions: switching AC or DC loads with different resistive, inductive and capacitive parts, switching voltages from a few mV up to 250 V, switching currents from a few mA up to 16 A, amplification of weak control signals, electrical isolation of control and load circuits, and signal multiplying.



### Temperature monitoring relays CM-TCS & CM-TCN monitor

overtemperature, undertemperature, or temperatures between two threshold values (window monitoring) with PT100 sensor. As soon as the temperature falls below or exceeds the threshold value the output relays change their positions according to the configured functionality and the front-face LEDs display the current status. Regardless of the selected configuration, the device is monitoring its measuring circuit for interrupted wires or short circuits.

# ABB CT-C Product Portfolio



CT-MFC.12



CT-ERC.22

\*Control input with voltage-related triggering\_No triggering

## Ordering details

Timing function	Rated control supply voltage	Time ranges	Control input	Output	Type	Order code	LP.(₹)
Multi 1)	12-240 V AC/DC	7 (0.05 s-100 h)	*	Solid State	CT-MKC.31	1SVR508010R1300	3,850
Multi 1)	24-240 V AC 24-48 V DC		*	1C/O	CT-MFC.12	1SVR508020R0000	3,510
Multi 1)	12-240 V AC/DC		*	2C/O	CT-MFC.21	1SVR508020R1100	9,790
Dual 2)	24-240 V AC 24-48 V DC	7 (0.05 s-10 min)	-	1C/O	CT-ARC.12	1SVR508120R0000	4,740
ON-delay			-	1C/O	CT-ERC.12	1SVR508100R0000	2,890
			-	2C/O	CT-ERC.22	1SVR508100R0100	5,720
OFF-delay		7 (0.05 s-100 h)	-	1C/O	CT-AHC.12	1SVR508110R0000	3,380
			-	2C/O	CT-AHC.22	1SVR508110R0100	6,120
Impulse-ON	24-240 V AC 24-48 V DC		*		CT-VWC.12	1SVR508130R0000	5,080
Flasher 3)			*	1C/O	CT-EBC.12	1SVR508150R0000	3,710
Pulse generator		2×7 (0.05 s-100 h)	-		CT-TGC.12 4)	1SVR508160R0000	6,120
			-	2C/O	CT-TGC.22 4)	1SVR508160R0100	7,350
Star-delta changeover		2×7 (0.05 s-100 h)	*		CT-SDC.22 5)	1SVR508211R0100	3,850
			*	2N/O	CT-SAC.22 6)	1SVR508210R0100	3,980

- 1) Functions: ON-delay, OFF-delay with auxiliary voltage, Impulse-ON, Impulse-OFF with auxiliary voltage, Flasher starting with ON, Flasher starting with OFF, Pulse former
- 2) OFF-delay without aux. voltage (True OFF-delay), True Impulse-OFF
- 3) Flasher starting with ON, Flasher starting with OFF
- 4) ON and OFF times adjustable independently: 2 x 7 time ranges 0.05 s - 100 h
- 5) Transition time 50 ms fixed
- 6) Transition time adjustable

**Connection terminals**  
Wide terminal spacing makes wiring connections easier:  
2 x 1.5 mm<sup>2</sup> (2 x 16 AWG) with wire end ferrules or 2 x 2.5 mm<sup>2</sup> (2 x 14 AWG) without ferrules.

**Preselection of the time range**  
Direct reading scales  
Direct setting of the time delay without any additional calculation provides accurate time delay adjustment.

**Selection of the timing function**

- ON-delay
- OFF-delay with aux. voltage
- Impulse-ON
- Impulse-OFF with aux. voltage
- Flasher starting with ON
- Flasher starting with OFF
- Pulse former

**Width 17.5 mm**  
With a width of just 17.5mm, CT-C time relays are ideal for installations with limited space.

**Control input to start timing**

**Fine adjustment of the time delay**

**LEDs for status indication**  
All actual operational states are displayed by front-facing LEDs, simplifying commissioning and troubleshooting.

- U - green LED: control supply voltage applied / timing
- R, R1, R2 - yellow LED: output relay energized

# ABB CT-S Product Portfolio



Type	Rated control supply voltage	Time range	Ordering code	L.P. (₹)
CT-MFS.21S	24-240 V AC/DC	10 (0.05 s- 300 h)	1SVR730010R0200	14,210

## CT-ERS.22: ON-delay (accumulative), 2 c/o

Type	Rated control supply voltage	Time range	Ordering code	L.P. (₹)
CT-ERS.22S	24-48 V DC, 24-240 V AC	10 (0.05 s- 300 h)	1SVR730100R3300	8,710

# Electronic products and relays

## Measuring and monitoring relays



### Single and three phase monitoring relays for phase failure detection

Type	Rated control supply voltage = measuring voltage		Ordering code	L.P.(₹)
CM-PBE	3x380-440 V AC, 220-240 V AC	With neutral monitoring	1SVR550881R9400	7,090
CM-PBE	3x380-440 V AC	Without neutral monitoring	1SVR550882R9500	7,090



### Single and three phase monitoring relays for over / undervoltage and phase failure detection

Type	Rated control supply voltage = measuring voltage		Ordering code	L.P.(₹)
CM-PVE	3x320-460 V AC, 185-265 V AC	With neutral monitoring	1SVR550870R9400 ■	6,880
CM-PVE	3x320-460 V AC	Without neutral monitoring	1SVR550871R9500	6,880



### Three phase monitoring relays for phase sequence monitoring and phase failure detection

Type	Rated control supply voltage = measuring voltage		Ordering code	L.P.(₹)
CM-PFS.S	3x200-500 V AC		1SVR730824R9300	5,230



### Three phase monitoring relays for over and undervoltage with adjustable threshold values

Type	Rated control supply voltage = measuring voltage		Ordering code	L.P.(₹)
CM-PVS.31P	3x160-300 V AC		1SVR740794R1300	23,880
CM-PVS.31S			1SVR730794R1300	19,700
CM-PVS.41P	3x300-500 V AC		1SVR740794R3300	21,260
CM-PVS.41S			1SVR730794R3300	21,260



### Three phase monitoring relays for phase unbalance

Type	Rated control supply voltage = measuring voltage		Ordering code	L.P.(₹)
CM-PAS.31P	3x160-300 V AC		1SVR740774R1300	22,710
CM-PAS.31S			1SVR730774R1300	19,700
CM-PAS.41P	3x300-500 V AC		1SVR740774R3300	22,710
CM-PAS.41S			1SVR730774R3300	19,700



### Multifunctional three phase monitoring relays (phase failure detection, phase sequence monitoring, overvoltage, undervoltage, phase unbalance)

Type	Rated control supply voltage = measuring voltage		Ordering code	L.P.(₹)
CM-MPS.11P	3x90-170 V AC		1SVR740885R1300	23,640
CM-MPS.11S		With interrupted neutral monitoring	1SVR730885R1300	22,040
CM-MPS.21P	3x180-280 V AC		1SVR740885R3300	22,840
CM-MPS.21S			1SVR730885R3300	21,680
CM-MPS.41S	3x300-500 V AC	Without interrupted neutral monitoring	1SVR730884R3300 ■	9,610

# Electronic products and relays

## Measuring and monitoring relays

### Three phase monitoring relays



**Multifunctional three phase monitoring relays, automatic phase sequence correction and separate monitoring of over and undervoltage (window monitoring) configurable**

Type	Rated control supply voltage = measuring voltage		Ordering code	L.P.(₹)
CM-MPS.23P	3x180-280 V AC	With interrupted neutral monitoring	1SVR740885R4300	28,990
CM-MPS.23S			1SVR730885R4300	25,520
CM-MPS.43P	3x300-500 V AC	Without interrupted neutral monitoring	1SVR740884R4300	27,960
CM-MPS.43S			1SVR730884R4300	23,140

**Multifunctional three phase monitoring relays, automatic phase sequence correction and separate monitoring of over and undervoltage (window monitoring) configurable**



Type	Rated control supply voltage = measuring voltage		Ordering code	L.P.(₹)
CM-MPN.52P	3x350-580 V AC		1SVR760487R8300	31,820
CM-MPN.52S			1SVR750487R8300	27,020
CM-MPN.62P	3x450-720 V AC		1SVR760488R8300	31,820
CM-MPN.62S			1SVR750488R8300	27,960
CM-MPN.72P	3x530-820 V AC		1SVR760489R8300	31,820
CM-MPN.72S			1SVR750489R8300 ■	27,960

### Insulation monitors for unearthed supply systems



Type	Nominal voltage Un of the distribution system to be monitored	Rated control supply voltage	Ordering code	L.P.(₹)
CM-IWS.1P	0-250 V AC / 0-300 V DC	24-240 V AC/DC	1SVR740660R0100	36,460
CM-IWS.1S			1SVR730660R0100 ■	35,110
CM-IWS.2P	0-400 V AC	24-240 V AC/DC	1SVR740670R0200	32,310
CM-IWS.2S			1SVR730670R0200 ■	28,850
CM-IWN.1P	0-400 V AC / 0-600 V DC	24-240 V AC/DC	1SVR760660R0200	91,770
CM-IWN.1S			1SVR750660R0200	66,800
Coupling unit				
CM-IVN.S	Passive device, no control supply voltage needed	0-690 V AC / 0-1000 V DC	1SVR750669R9400 ■	34,940
CM-IVN.P			1SVR760669R9400	42,530

### Thermistor motor protection relays



Type	Rated control supply voltage		Ordering code	L.P.(₹)
CM-MSE	24 V AC		1SVR550805R9300	7,750
	110-130 V AC		1SVR550800R9300 ■	5,900
	220-240 V AC		1SVR550801R9300 ■	7,750
CM-MSS.12S	24 V AC/DC		1SVR730700R0100	9,850
CM-MSS.12P	24 V AC/DC		1SVR740700R0100	10,390
CM-MSS.13S	110-130 V AC/220-240 V AC		1SVR730700R2100	9,280
CM-MSS.13P	110-130 V AC/220-240 V AC		1SVR740700R2100	10,390
CM-MSS.22S	24 V AC/DC		1SVR730700R0200	9,910
CM-MSS.22P	24 V AC/DC		1SVR740700R0200	11,380
CM-MSS.23S	110-130 V AC/220-240 V AC		1SVR730700R2200	9,910
CM-MSS.23P	110-130 V AC/220-240 V AC		1SVR740700R2200	11,380

■ Stock items

# Electronic products and relays

## Pluggable interface relays



CR-M

### Ordering details - CR-M range without LED

Version	Outputs	Type	Ordering code	L.P.(₹)
12 V DC	2 c/o (SPDT)	CR-M012DC2	1SVR405611R4000	818
24 V DC		CR-M024DC2	1SVR405611R1000 ■	818
48 V DC		CR-M048DC2	1SVR405611R6000	818
60 V DC		CR-M060DC2	1SVR405611R4200	818
110 V DC		CR-M110DC2	1SVR405611R8000 ■	912
125 V DC		CR-M125DC2	1SVR405611R8200	910
220 V DC		CR-M220DC2	1SVR405611R9000	850
24 V AC		CR-M024AC2	1SVR405611R0000	850
48 V AC		CR-M048AC2	1SVR405611R5000	850
110 V AC		CR-M110AC2	1SVR405611R7000	850
120 V AC	CR-M120AC2	1SVR405611R2000	850	
230 V AC	CR-M230AC2	1SVR405611R3000 ■	946	
12 V DC	4 c/o (SPDT)	CR-M012DC4	1SVR405613R4000	818
24 V DC		CR-M024DC4	1SVR405613R1000 ■	818
48 V DC		CR-M048DC4	1SVR405613R6000	860
60 V DC		CR-M060DC4	1SVR405613R4200	828
110 V DC		CR-M110DC4	1SVR405613R8000 ■	946
125 V DC		CR-M125DC4	1SVR405613R8200 ■	954
220 V DC		CR-M220DC4	1SVR405613R9000 ■	998
24 V AC		CR-M024AC4	1SVR405613R0000	954
48 V AC		CR-M048AC4	1SVR405613R5000	902
110 V AC		CR-M110AC4	1SVR405613R7000 ■	954
120 V AC	CR-M120AC4	1SVR405613R2000	954	
230 V AC	CR-M230AC4	1SVR405613R3000 ■	998	

### Ordering details - CR-M range with LED

Version	Outputs	Type	Ordering code	L.P.(₹)
12 V DC	2 c/o (SPDT)	CR-M012DC2L	1SVR405611R4100	818
24 V DC		CR-M024DC2L	1SVR405611R1100 ■	838
48 V DC		CR-M048DC2L	1SVR405611R6100	850
60 V DC		CR-M060DC2L	1SVR405611R4300	850
110 V DC		CR-M110DC2L	1SVR405611R8100	954
125 V DC		CR-M125DC2L	1SVR405611R8300	954
220 V DC		CR-M220DC2L	1SVR405611R9100	986
24 V AC		CR-M024AC2L	1SVR405611R0100	944
48 V AC		CR-M048AC2L	1SVR405611R5100	860
110 V AC		CR-M110AC2L	1SVR405611R7100	944
120 V AC	CR-M120AC2L	1SVR405611R2100	954	
230 V AC	CR-M230AC2L	1SVR405611R3100	998	
12 V DC	4 c/o (SPDT)	CR-M012DC4L	1SVR405613R4100	1,018
24 V DC		CR-M024DC4L	1SVR405613R1100 ■	1,018
48 V DC		CR-M048DC4L	1SVR405613R6100	1,018
60 V DC		CR-M060DC4L	1SVR405613R4300	910
110 V DC		CR-M110DC4L	1SVR405613R8100 ■	1,124
125 V DC		CR-M125DC4L	1SVR405613R8300	1,124
220 V DC		CR-M220DC4L	1SVR405613R9100 ■	1,188
24 V AC		CR-M024AC4L	1SVR405613R0100	1,124
48 V AC		CR-M048AC4L	1SVR405613R5100	1,124
110 V AC		CR-M110AC4L	1SVR405613R7100	1,124
120 V AC	CR-M120AC4L	1SVR405613R2100	1,018	
230 V AC	CR-M230AC4L	1SVR405613R3100 ■	1,178	



CR-M



CR-M45S

### Ordering details - CR-M range accessories

Version	Type	Ordering code	L.P.(₹)
Standard socket for 2 c/o	CR-M2SS	1SVR405651R1000 ■	516
Standard socket for 2/4 c/o	CR-M4SS	1SVR405651R3000 ■	552
Plastic holder	CR-MH	1SVR405659R1000 ■	68
Metal holder	CR-MH1	1SVR405659R1100 ■	57

■ Stock items

# Electronic products and relays

## Pluggable interface relays

### Ordering details - CR-MX range with LED



Version	Outputs	Type	Ordering code	L.P.(₹)	
12 V DC	2 c/o (SPDT), 250 V, 7 A	CR-MX012DC2L	1SVR405631R4100	340	
24 V DC		CR-MX024DC2L	1SVR405631R1100 ■	374	
48 V DC		CR-MX048DC2L	1SVR405631R6100	400	
110 V DC		CR-MX110DC2L	1SVR405631R8100 ■	374	
220 V DC		CR-MX220DC2L	1SVR405631R9100	670	
24 V AC		CR-MX024AC2L	1SVR405631R0100 ■	340	
110 V AC		CR-MX110AC2L	1SVR405631R7100	340	
230 V AC		CR-MX230AC2L	1SVR405631R3100 ■	400	
12 V DC		4 c/o (SPDT), 250 V, 5 A	CR-MX012DC4L	1SVR405633R4100	400
24 V DC			CR-MX024DC4L	1SVR405633R1100 ■	420
48 V DC	CR-MX048DC4L		1SVR405633R6100	432	
110 V DC	CR-MX110DC4L		1SVR405633R8100 ■	432	
220 V DC	CR-MX220DC4L		1SVR405633R9100	730	
24 V AC	CR-MX024AC4L		1SVR405633R0100 ■	432	
110 V AC	CR-MX110AC4L		1SVR405633R7100 ■	470	
230 V AC	CR-MX230AC4L		1SVR405633R3100 ■	470	

### Ordering details - CR-MX range with Integrated LED & Test Button



Version	Outputs	Type	Ordering code	L.P.(₹)	
12 V DC	2 c/o (SPDT), 250 V, 7 A	CR-MX012DC2LT	1SVR405641R4100	424	
24 V DC		CR-MX024DC2LT	1SVR405641R1100 ■	445	
48 V DC		CR-MX048DC2LT	1SVR405641R6100	470	
110 V DC		CR-MX110DC2LT	1SVR405641R8100 ■	470	
220 V DC		CR-MX220DC2LT	1SVR405641R9100	742	
24 V AC		CR-MX024AC2LT	1SVR405641R0100 ■	466	
110 V AC		CR-MX110AC2LT	1SVR405641R7100	490	
230 V AC		CR-MX230AC2LT	1SVR405641R3100 ■	520	
12 V DC		4 c/o (SPDT), 250 V, 5 A	CR-MX012DC4LT	1SVR405643R4100	490
24 V DC			CR-MX024DC4LT	1SVR405643R1100 ■	510
48 V DC	CR-MX048DC4LT		1SVR405643R6100	520	
110 V DC	CR-MX110DC4LT		1SVR405643R8100 ■	530	
220 V DC	CR-MX220DC4LT		1SVR405643R9100	840	
24 V AC	CR-MX024AC4LT		1SVR405643R0100 ■	530	
110 V AC	CR-MX110AC4LT		1SVR405643R7100 ■	552	
230 V AC	CR-MX230AC4LT		1SVR405643R3100 ■	552	

### Ordering details - Accessories\* - CR-MX range



CR-MX with Base and Holder

Version	Type	Ordering code	L.P.(₹)
For 2 c/o (SPDT) contacts, black	CR-M2SFB	1SVR405651R1400 ■	188
For 2 or 4 c/o (SPDT) contacts, black	CR-M4SFB	1SVR405651R3400 ■	246
Metal holder	CR-MH1	1SVR405659R1100 ■	58

■ Stock items

# Primary switch mode power supplies

## CP-Range



- Five power supplies families from single- to three-phase and economic- to high end versions for every industrial application
- ABB power supplies – preferred by engineers – for their compact, space saving design and ability to accept almost any input voltage



### CP-D range

Distribution panel design The CP-D range of power supply units in MDRC design (modular DIN rail components) fits into all domestic installation and distribution panels. With their width between 18 to 90 mm only, the CP-D range switch mode power supplies are ideally suited for installation in distribution panels. The range is optimized for world-wide applications: The CP-D power supplies can be supplied with 90-264 V AC or 120-375 V DC. The continuously adjustable output voltage (CP-D > 10 W) ensures optimal adaption to the application, e.g. compensating the voltage drop caused by a long line length. Additional redundancy unit CP-RUD available to establish true redundancy is available.



### CP-E range

Economy range The CP-E range offers enhanced functionality while the number of different types has been considerably reduced. Now all power supply units can be operated at an ambient temperature of up to +70 °C. The CP-E range 24 V devices over 18 W offer an output/ contact for monitoring of the output voltage and remote diagnosis. Optimized for world-wide applications, the CP-E power supplies can be supplied within a wide range of AC or DC voltage. The output voltage is continuously adjustable, ensuring optimal adaptation to the application, e.g. compensating the voltage drop caused by a long line length. For decoupling of parallel connected power supplies below or equal 56 V, redundancy modules are available in order to achieve true redundancy.



#### **CP-T Three-phase range**

The CP-T range of three-phase power supply units perfectly complements existing power supply offering in terms of design and functionality, giving you more advanced options for your three[1]phase applications. Solid state output for function monitoring and remote diagnostics is available. The range is to be used in 340 - 575 V AC or 480 - 820 V DC supply systems. Its continuously adjustable output voltage ensures optimal adaptation to the application, e.g. compensating the voltage drop caused by a long line length.



#### **CP-S.1 power supplies**

High efficiency and reliability delivered in a compact footprint. Designed for a huge variety of applications, including machine building segments, this advanced range boasts an integrated 150 % power reserve for five seconds and operates at an efficiency of up to 94 %. With overheat protection, active power factor correction, a broad certified AC and DC input range and extensive worldwide approvals including marine, the all-new CP-S.1 power supplies are a preferred choice for multiple industrial applications



#### **CP-C.1 range High-performance range**

The CP-C.1 power supplies are ABB's high-performance and most advanced range. With excellent efficiency, high reliability and innovative functionality it is prepared for the most demanding industrial applications. These power supplies have a 150 % integrated power reserve and operate at an efficiency of up to 94 %. They are equipped with overheat protection and active power factor correction. Combined with a broad AC and DC input voltage range and extensive worldwide approvals the CP-C.1 power supplies are the preferred choice for professional DC applications. Giving the power to control



#### **CP-B range Short time buffers**

ABB offers an innovative and completely maintenance- free product range for buffering the 24 V DC supply in case of interrupted mains on the primary side of the switch mode power supply. • Ultra cap based buffer modules for short time UPS systems • Rated input voltage 24 V DC • Rated currents 3 A, 10 A and 20 A • Expandable with CP-B EXT.2 module • LEDs for status indication • High efficiency, higher than 90% • Signaling and status outputs • Buffering times at 100% load current from 13 s to 38 s (depending on device)



### CP-T range



Rated I/P voltage	Rated O/P Voltage/Current	Type	Ordering code	L.P. (₹)
340-575 V AC/ 480-820 V DC	24 V DC / 5 A	CP-T 24/5.0	1SVR427054R0000	17,050
340-575 V AC/ 480-820 V DC	24 V DC / 10 A	CP-T 24/10.0	1SVR427055R0000	21,710
340-575 V AC/ 480-820 V DC	24 V DC / 20 A	CP-T 24/20.0	1SVR427056R0000	26,930
340-575 V AC/ 480-820 V DC	24 V DC / 40 A	CP-T 24/40.0	1SVR427057R0000	39,850
340-575 V AC/ 480-820 V DC	48 V DC / 5 A	CP-T 48/5.0	1SVR427054R2000	23,600
340-575 V AC/ 480-820 V DC	48 V DC / 10 A	CP-T 48/10.0	1SVR427055R2000	32,260
340-575 V AC/ 480-820 V DC	48 V DC / 20 A	CP-T 48/20.0	1SVR427056R2000	47,190

### CP-C.1



Input voltage range	Rated output Voltage/Current	Type	Ordering code	L.P. (₹)
100-240 V AC, 90-300 V DC	24 V DC / 5 A	CP-C.1 24/5.0	1SVR360563R1001	29,940
100-240 V AC, 90-300 V DC	24 V DC / 10 A	CP-C.1 24/10.0	1SVR360663R1001	47,550
100-240 V AC, 90-300 V DC	24 V DC / 20 A	CP-C.1 24/20.0	1SVR360763R1001	74,250

### CP-S.1



Input voltage range	Rated output Voltage/Current	Type	Ordering code	L.P. (₹)
100-240 V AC, 100-250 V DC	24 V DC / 3 A	CP-S.1 24/3.0 Power supply	1SVR320361R1000	12,120
100-240 V AC, 100-250 V DC	24 V DC / 5 A	CP-S.1 24/5.0 Power supply	1SVR320561R1000	15,500
100-240 V AC, 100-250 V DC	24 V DC / 10 A	CP-S.1 24/10.0 Power supply	1SVR320661R1000	25,950
100-240 V AC, 100-250 V DC	24 V DC / 20 A	CP-S.1 24/20.0 Power supply	1SVR320761R1000	41,710
110-240 V AC, 110-250 V DC	24 V DC / 40 A	CP-S.1 24/40.0 Power supply	1SVR320861R1000	89,650
10 - 58 V DC	12 - 48 V DC 2 x 20 A or 1 x 40 A	CP-C.1-A-RU	1SVR360060R1001	19,680

### CP-E range



Rated I/P voltage	Rated O/P Voltage/Current	Type	Ordering code	L.P. (₹)
100-240 V AC	5 V DC / 3 A	CP-E 5/3.0	1SVR427033R3000	8,650
100-240 V AC	12 V DC / 2.5 A	CP-E 12/2.5	1SVR427032R1000 ■	8,950
115 / 230 V AC auto select	12 V DC / 10 A	CP-E 12/10.0	1SVR427035R1000 ■	16,470
100-240 V AC	24 V DC / 0.75 A	CP-E 24/0.75	1SVR427030R0000	6,620
100-240 V AC	24 V DC / 1.25 A	CP-E 24/1.25	1SVR427031R0000 ■	7,210
100-240 V AC	24 V DC / 2.5 A	CP-E 24/2.5	1SVR427032R0000 ■	7,430
115 / 230 V AC auto select	24 V DC / 5 A	CP-E 24/5.0	1SVR427034R0000 ■	13,420
115 / 230 V AC auto select	24 V DC / 10 A	CP-E 24/10.0	1SVR427035R0000 ■	19,470
115 / 230 V AC	24 V DC / 20 A	CP-E 24/20.0	1SVR427036R0000 ■	34,730
100-240 V AC	48 V DC / 0.625 A	CP-E 48/0.62	1SVR427030R2000	9,230
100-240 V AC	48 V DC / 1.25 A	CP-E 48/1.25	1SVR427031R2000	11,700
115 / 230 V AC auto select	48 V DC / 5 A	CP-E 48/5.0	1SVR427034R2000	23,680
115 / 230 V AC	48 V DC / 10 A	CP-E 48/10.0	1SVR427035R2000 ■	33,750

Note: Refer technical data sheet for DC voltage input range

### CP-PX Panel Mounted Power Supply



Input voltage range	Rated output Voltage/Current/Power	Type	MOQ	Ordering code	L.P. (₹)
90-264 V AC	24 V DC / 2.2 A / 25 Watt	CP-PX 24/2.2	20	1SVR427091R0020	2,500
90-132/180-264VAC, by dip switch	24 V DC / 4.5 A / 100 Watt	CP-PX 24/4.5	20	1SVR427091R0040	3,710
90-132/180-264VAC, by dip switch	24 V DC / 6.5 A / 150 Watt	CP-PX 24/6.5	20	1SVR427091R0050	4,440
90-132/180-264VAC, by dip switch	24 V DC / 10.5 A / 250 Watt	CP-PX 24/10.5	10	1SVR427091R0060	6,760
90-132/180-264VAC, by dip switch	24 V DC / 14.6 A / 350 Watt	CP-PX 24/14.6	10	1SVR427091R0070	10,920

#### Accessories for DIN-rail installation

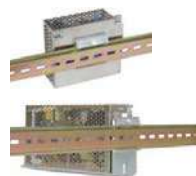

All CP-PX products (for flat rail mounting) Flat rail mounting feet (including required screws 1)	DIN Rail Mounting	CP-PX-A-DINCLIP	10	1SVR427091R9000	90
24 V DC / 2.2 A L-bracket 2	Vertical Mounting	CP-PX-A-LBR.03	10	1SVR427091R9120	210
24 V DC / 4.5 A L-bracket 2	Vertical Mounting	CP-PX-A-LBR.05	10	1SVR427091R9140	270
24 V DC / 6.5 A L-bracket 2	Vertical Mounting	CP-PX-A-LBR.06	10	1SVR427091R9150	300
24 V DC / 10.5 A and 24 V DC / 14.6 A L-brackets 2	Vertical Mounting	CP-PX-A-LBR.07	10	1SVR427091R9160	360

■ Stock items

# Smart temperature monitoring relay **NEW**

Reduced stocks, flexible adjustment  
and easy setup: One relay for all applications.

## One...



### look

back-lit LCD for easy reading and setup



### touch

NFC parametrization via smartphone



### device

for a wide range of applications



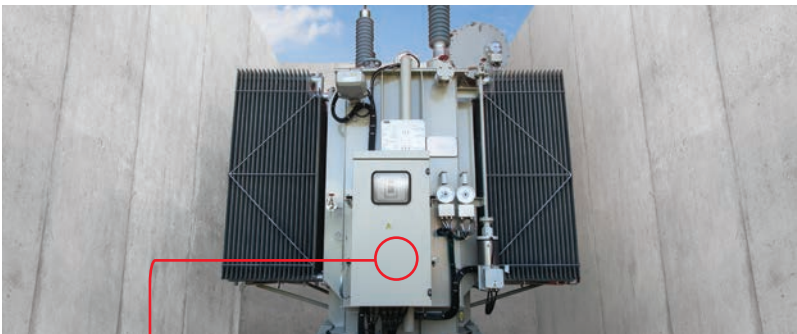

Temperature sensor, e.g. PT100



Smart temperature monitoring relay



ABB EPIC smartphone app



ABB Ability™ Energy and Asset Manager



ABB Ability™ Edge Industrial Gateway

Modbus RS-485

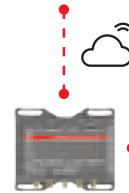

CM-TCN.012

Description	Type	Ordering code	L.P.(₹)
Temperature monitoring relay, Temp.-range -200..+850°C, width 45mm,digital adjustable, 3 thresholds, over temperature-, under temperature-, window monitoring, A1-A2=24-240V AC / DC, 3 c/o, Screw connection terminals	CM-TCN.011S	1SVR750740R0110	41,250
Temperature monitoring relay, Temp.-range -200..+850°C, width 45mm,digital adjustable, 3 thresholds, over temperature-, under temperature-, window monitoring, A1-A2=24-240V AC / DC, 3 c/o, Pushin connection terminals	CM-TCN.011P	1SVR760740R0110	41,820
Temperature monitoring relay, Temp.-range -200..+850°C, width 45mm,digital adjustable, 3 thresholds, over temperature-, under temperature-, window monitoring, A1-A2=24-240V AC / DC, 3 c/o, Screw connection terminals" Temp. monitoring relays with Modbus RS-485	CM-TCN.012S	1SVR750740R0120	45,330
Temperature monitoring relay, Temp.-range -200..+850°C, width 45mm,digital adjustable, 3 thresholds, over temperature-, under temperature-, window monitoring, A1-A2=24-240V AC / DC, 3 c/o, Pushin connection terminals" Temp. monitoring relays with Modbus RS-485	CM-TCN.012P	1SVR760740R0120	45,990

# Intelligent motor management system - UMC100.3

## Ordering details - Universal Motor Controller UMC100.3



UMC100.3 DC

2CDC34106V0014



UMC100.3 UC

2CDC 341 007 V0014



UMC100-PAN

2CDC 341 008 V0014

### Description

Intelligent motor management system for single and three-phase motors with  $I_e = 0.24 - 63$  A in one single device. Compact housing with integrated current transformer for cable cross section up to  $25 \text{ mm}^2$  (max.  $\varnothing$  with Insulation 11 mm). Higher currents with additional external current transformer. Thermal overload protection according to EN/IEC 60947-4-1, selectable trip classes 5E, 10E, 20E, 30E, 40E. Some functions require an additional expansion module.

- **Motor protection functions:**  
Over-/underload, over-/undercurrent, over-/undervoltage, rotor blocking, phase failure/imbalance/sequence Earth fault detection integrated or with external sensor CEM11  
Hot motor protection with thermistor or temperature measurement
- **Motor control functions:**  
Easily configurable motor control functions: direct, reverse, star-delta starter, pole-changing, overload relay, actuator mode, softstarter mode. Additionally free programmable application specific logic with function blocks
- **Service and diagnostic data:**  
Operating hours, number of motor starts and overload trips, energy, standstill and operation hours supervision, motor status, faults and warnings, fault history (16 events)  
Motor current, phase voltages, thermal load, power factor (cos), active power, apparent power, energy, total harmonic distortion (THD).
- **Integrated I/Os:**  
6 digital inputs, 1 PTC input, 4 digital outputs. Maximum number of I/Os with expansion modules:  
14 digital inputs, 1 PTC input, 9 digital outputs, 6 analogue inputs, 1 analogue output
- **Communication interfaces for fieldbuses and ethernet networks, interface for operator panel UMC100-PAN, bus interface for connection of expansion modules**
- **Versions for supply voltage 24 V DC and 110 – 240 V AC/DC and with ATEX approval**

### Ordering details

Designation	Supply voltage	Type	Ordering code	L.P. (₹)
Universal Motor Controller	24 V DC	UMC100.3 DC	1SAJ530000R0100	
Universal Motor Controller	110-240 V AC/DC	UMC100.3 UC	1SAJ530000R1100	
Universal Motor Controller, ATEX	24 V DC	UMC100.3 DC EX	1SAJ530000R0200	
Universal Motor Controller, ATEX	110-240 V AC/DC	UMC100.3 UC EX	1SAJ530000R1200	Upon request
Universal Motor Controller, DC, ATEX, Conformal Coating	24 V DC	UMC100.3 DC EX	1SAJ530000R0210	
Universal Motor Controller, UC, ATEX, Conformal Coating	110-240 V AC/DC	UMC100.3 DC EX	1SAJ530000R1210	

### Operating panel UMC100-PAN

Operator panel for Universal Motor Controller UMC100. Backlit graphical and multilingual fulltext display, LEDs for status. Assembly directly on UMC100 or on the control cabinet door via extension cable and door mounting set.

### Functions:

- **Monitoring:** Shows motor status and diagnostics
- **Operate:** Start, stop, fault reset
- **Parametrize:** Setting and changing of motor and fieldbus parameters (password protection possible)
- **Copy settings**
- **USB port for up/download of parameters and logic**

Supports 8 languages: English, French, German, Italian, Spanish, Polish, Portuguese, Russian  
Replaces all former UMC100 operator panels

### Ordering details

Designation	Type	Ordering code	L.P. (₹)
Operating panel	UMC100-PAN	1SAJ590000R0103	
0.7 m ext. cable with door mounting set	UMCPAN-CAB.070	1SAJ510003R0002	Upon request
1.5 m ext. cable with door mounting set	UMCPAN-CAB.150	1SAJ510004R0002	
3 m ext. cable with door mounting set	UMCPAN-CAB.300	1SAJ510002R0002	

# Intelligent motor management system - UMC100.3

## Ordering details - Expansion modules



DX111-FBP

2CDC 341 005 F0009

### Description

Up to 4 expansion-modules can be connected to one UMC100.3

- 1 digital expansion module DX111 or DX122
- 1 voltage expansion module VI150 or VI155
- 2 analog/temperature expansion modules AI111 possible)

Supply voltage is 24 V DC; the 110-240 V AC/DC version of the UMC100.3 provides the 24 V DC supply for expansion modules

### DX111

I/O-expansion module with 8 digital inputs 24 V DC, 4 relay outputs, 1 analog output 0/4-20 mA or 0...10 V

### DX122

I/O-expansion module with 8 digital inputs 110 / 230 V AC, 4 relay outputs, 1 analog output 0/4-0 mA or 0-10 V

### VI15x

Voltage modules for the determination of phase voltages, power factor ( $\cos \phi$ ), apparent power, energy, total harmonic distortion (THD).

For use in grounded networks (VI150) or in all networks (VI155), 150-690 V AC

### AI111

Analog / temperature expansion module, 3 inputs PT100, PT1000, KTY83, KTY84, NTC, 0-10 V, 0/4-20 mA

1 or 2 modules AI111 can be connected to an UMC100.3.



DX122-FBP

2CDC 341 004 F0009



VI150-FBP

2CDC 345 001 S0011



VI155-FBP

2CDC 345 002 S0011

### Ordering details

Designation	Type	Ordering code	L.P.(₹)
I/O module for UMC100, 24 V DC digital input	DX111	1SAJ611000R0101	
I/O module for UMC100, 110 – 230 V AC digital input	DX122	1SAJ622000R0101	
3 phase voltage module for grounded networks	VI150	1SAJ650000R0100	
3 phase voltage module for all networks	VI155	1SAJ655000R0100	
Analog/temperature module 3 analogue inputs	AI111	1SAJ613000R0101	
Connection cable UMC100 - I/O module, length 0.30 m	UMCIO-CAB.030	1SAJ691000R0001	Upon request
Connection cable IO-module - IO-module, length 0,30 m	IOIO-CAB.030	1SAJ692000R0001	
Terminal set for UMC100.3 DC (spare parts)	UMCTB	1SAJ929160R0001	
Terminal set for UMC100.3 UC (spare parts)	UMCTB	1SAJ929160R0002	

# Fieldbus interfaces

## Ordering details



PDP32.0



MRP31.0



DNP31.0



PDR31.0

### Description

Fieldbus communication interfaces enable the UMC100.3 to communicate via fieldbus. The interfaces can be used in two ways:

- Mounted directly on an UMC100.3 – the interface is supplied from the UMC100.3 and no additional accessory is required
- Mounted separately on a SMK3.0 adapter in the cable chamber of an MCC, the interface plugged on SMK3.0 requires a 24 V DC supply. Ready-made cables for applications in withdrawable systems are available, as well as terminal blocks for other cables:  
CDP18.150: Cable for use inside the drawer CDP24.150: Cable from SMK3.0 to drawer outside

### PDP32.0

- Communication interface for PROFIBUS DP; supports the protocols PROFIBUS DP/V0 and V1
- PNO-certified PROFIBUS slave
- Data transfer rate up to 12 Mbit/s
- Diagnostic LEDs
- Fieldbus connection via nine-pole Sub-D connector or terminal blocks
- GSD download from UMC100.3 webpage

### MRP31.0

- Communication interface for Modbus RTU
- Data transfer rate up to 57.6 kbit/s
- Diagnostic LEDs
- Fieldbus connection via terminal blocks

### DNP31.0

- Communication interface for DeviceNet
- ODVA-certified DeviceNet slave
- Data transfer rate up to 500 kbit/s
- Diagnostic LEDs
- Fieldbus connection via terminal blocks
- EDS download from UMC100.3 webpage

### PDR31.0

- External active fieldbus termination for Profibus DP; the PDR31.0 needs to be mounted on a SMK3.0 adapter and supplied by 24 V DC

Description	Type	Order code	L.P. (₹)
Profibus DP communication interface	PDP32.0	1SAJ242000R0001	
Modbus RTU communication interface; terminal block for fieldbus connection included	MRP31.0	1SAJ251000R0001	
DeviceNet communication interface; terminal block for fieldbus connection included	DNP31.0	1SAJ231000R0001	Upon request
Profibus DP active bus termination	PDR31.0	1SAJ243000R0001	

# Ethernet interfaces

## Ordering details



MTQ22-FBP.0

ZCDC34100350002

### Description

Ethernet communication interfaces enable the UMC100.3 to communicate via an Ethernet network. There are two types of interfaces:

Interfaces for the connection of one to four Universal Motor Controllers UMC100.3:

- MTQ22-FBP.0 for Modbus TCP
- PNQ22-FBP.0 for Profinet IO

Interface for a single universal motor controller UMC100.3:

- EIU32.0 for EtherNet/IP™



PNQ22-FBP.0

ZCDC34100150004

### MTQ22-FBP.0

- Protocol Modbus TCP
- For one to four UMC100.3
- Master supervision with timeout control for up to four masters
- Micro USB-port for configuration via PC (configuration software downloaded from UMC100.3 webpage)
- Integrated Ethernet switch
- Supports all network topologies
- Ring topology with redundancy (MRP protocol)
- Easy to use in withdrawable applications
- No special Ethernet connectors required in MCCs
- 24 V DC supply voltage
- DIN-rail mounting



EIU32.0

ZCDC34100900018

### PNQ22-FBP.0

- Protocol Profinet IO
- PNO-certified
- For one to four UMC100.3 devices
- Integrated Ethernet switch
- Supports all network topologies
- Ring topology with redundancy (MRP protocol)
- Easy to use in withdrawable applications
- No special Ethernet connectors required in MCCs
- Fully integrated into ABB 800xA
- Time-stamped events with ABB 800xA
- 24 V DC supply voltage
- DIN-rail mounting
- GSDML downloaded from UMC100.3 webpage

### EIU32.0

- Protocol EtherNet/IP™
- ODVA-certified
- For one motor controller UMC100.3
- Mounting directly on an UMC100.3 (supplied by UMC100.3) or remotely on a SMK3.0 adapter (24 V DC supply required)
- Integrated Ethernet switch
- Supports all network topologies
- DLR (Device Level Ring) function for redundancy
- Easy to use in withdrawable applications
- No special Ethernet connectors required in MCCs
- EDS download from UMC100.3 webpage

### Highlighted features:

- The PNU32.0 Ethernet adapter module provides Ethernet connectivity for the motor controller UMC100.3
- Through the PNU32.0 Ethernet Adapter module it is possible to:
  - give control commands to the device (Start, Stop, Auto, etc.). The commands' meaning depends on the connected device
  - read status information and actual values from the device
  - change parameter values
  - read maintenance counters
  - reset a trip
- The PNU32.0 supports the Profinet S2 redundancy function
- Configuration from within the control system by using start-up parameters (similar to block parameters of PROFIBUS)
- A built-in two-port switch allows the flexible usage in bus, star or ring network topologies
- The Media Redundancy Protocol (MRP) is implemented (client). MRP is standardized in IEC/EN 62439-2 and offers cable redundancy in case of a single failure
- Location supervision for the detection of interchanged drawers in withdrawable systems
- Time stamped diagnosis: ABB proprietary Sequence of Event (SoE) support (800xA)



PNU32

**NEW**



PNU32+SMK3.0

**NEW**

Designation	Type	Ordering code	L.P. (₹)
Ethernet Modbus TCP interface	MTQ22-FBP.0	1SAJ260000R0100	
Ethernet Profinet IO interface	PNQ22-FBP.0	1SAJ261000R0100	Upon request
EtherNet/IPTM interface	EIU32.0	1SAJ262000R0100	
Ethernet Profinet IO interface	PNU32.0	1SAJ263000R0100	

# Adapter and accessories

## Ordering details

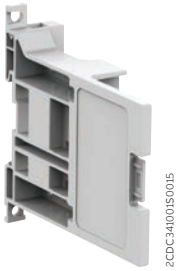

SMK3.0

2CDC34100150015



CDP18.150

2CDC341007F0018



PDP32.0 on SMK3.0

2CDC345008W0014



EIU32.0 on SMK3.0

2CDC341001V0018

### Adapter and ready-made cables

Adapter SMK3.0 for external mounting of a fieldbus or EtherNet/IP™ interface EIU32.0 outside a drawer. SMK3.0 can be mounted on a DIN-rail or fixed by screws. 24 V DC supply is required. Ready-made cables for inside and outside the drawer, including a terminal block on one side and open end on the other. Terminal blocks are also separately available for making own cables.

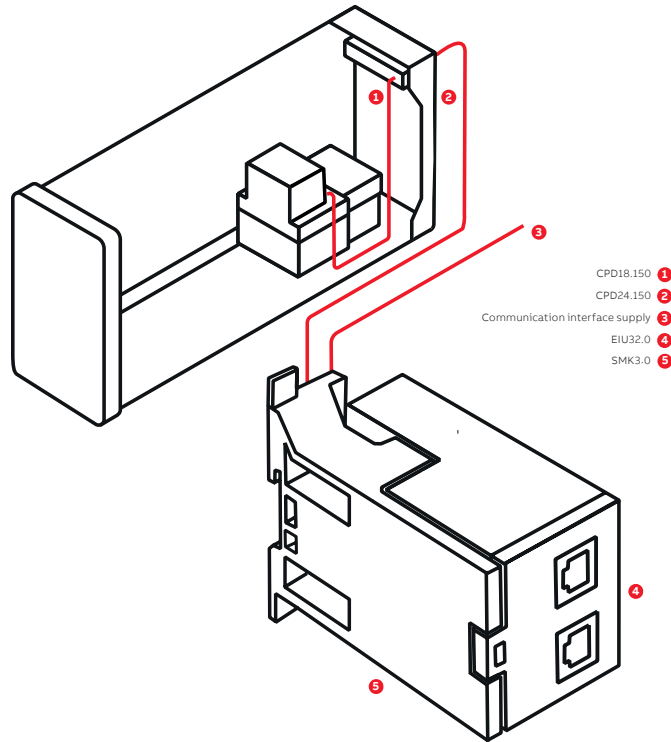

- CPD18.150 1
- CPD24.150 2
- Communication interface supply 3
- EIU32.0 4
- SMK3.0 5

Separate wiring of the EtherNet/IP™ communication interface EIU32.0

Description	Type	Order code	L.P. (₹)
Adapter for separate mounting of a communication interface; terminal block for 24 V DC supply included	SMK3.0	1SAJ929600R0001	
Cable for use inside drawer, length 1.5 m	CDP18.150	1SAJ929180R0015	
Cable from SMK3.0 to drawer's outside, length 1.5 m	CDP24.150	1SAJ929240R0015	
Terminal block 2-pole for SMK3.0 supply (spare parts)	SMK3-X2.10	1SAJ929610R0001	
Terminal block 5-pole for SMK3.0 comm. (spare parts)	SMK3-X1.10	1SAJ929620R0001	
Cable for inside and outside drawer, length 1.5 m	CDP18.150	1SAJ929180R0015	Upon request
Cable Ethernet interface - UMC100.3, length 1.5 m	CDP23.150	1SAJ929230R0015	
Cable Ethernet interface - UMC100.3, length 3 m	CDP23.300	1SAJ929230R0030	
Cable from SMK3.0 to drawer's outside, length 1.5 m	CDP24.150	1SAJ929240R0015	
Terminal blocks for MTQ22/PNQ22 X1...X4	ETHTB-FBP.4	1SAJ929200R0001	
Terminal blocks for MTQ22/PNQ22 X1...X4	ETHTB-FBP.50	1SAJ929200R0002	



# Earth fault monitors, current transformers

## Ordering details



2CDC34501P0008

CEM11-FBP.xxx

### Earth fault monitors CEM11-FBP.xxx for use with the Universal Motor Controller UMC100.3

The CEM11-FBP.xxx device monitors if the sum of the currents flowing through it is zero (factorial addition). If the sum is zero, no residual current is present. If the residual current is above an adjusted threshold value, the output signal of the CEM11-FBP.xxx changes. It can be used in motor feeders to detect leakage currents, as well as ground faults, caused for example by insulation breakdowns.

- CEM11-FBP.xxx is connected to a digital input of the UMC100.3
- Earth fault current threshold can be set in eight steps with a screwdriver
- Test position for easy control of the wiring

CEM11-FBP.xxx is delivered with adapters for DIN-rail or wall mounting.  
CEM-11.FBP.120 is for wall-mounting only.



2CDC34001S0012

CT4L185R/4, CT4L310R/4

Earth fault currents [mA]	Through-hole diameter	Type	Order code	L.P. (₹)
80 <sup>1)</sup> , 300, 550, 750, 1000, 1200, 1500, 1700	20 mm	CEM11-FBP.20	1SAJ929200R0020	Upon request
100 <sup>1)</sup> , 500, 1000, 1400, 2000, 2400, 3000, 3400	35 mm	CEM11-FBP.35	1SAJ929200R0035	
120 <sup>1)</sup> , 1000, 2000, 2800, 4000, 4800, 6000, 6800	60 mm	CEM11-FBP.60	1SAJ929200R0060	
300 <sup>1)</sup> , 2000, 4000, 5600, 8000, 9600, 12000, 13600	120 mm	CEM11-FBP.120	1SAJ929200R0120	

<sup>1)</sup> Lower values have higher inaccuracy



2CDC34002S0012

CT5L500R/4, CT5L850R/4

### Current transformers for use with the Universal Motor Controller UMC100.3

Linear type three-phase transformers, for use with the UMC100.3 and nominal motor currents >63 A. Terminal blocks for conductors Cu 2.5 mm<sup>2</sup> for wiring on the UMC100.3 side.

Description	Recommended current range	Type	Order code	L.P. (₹)
Current transformer	60...185 A AC	CT4L185R/4	1SAJ929500R0185	Upon request
Current transformer	180...310 A AC	CT4L310R/4	1SAJ929500R0310	
Current transformer	300...500 A AC	CT5L500R/4	1SAJ929501R0500	
Current transformer	500...850 A AC	CT5L850R/4	1SAJ929501R0850	

UMC100-FBP.0 and FBP system accessories are being phased out. Please contact your local ABB contact for spare parts or retrofit solutions.

# Arc flash protection and mitigation solutions

## Passive, active and preventive

Most short circuit faults in LV and MV switchgears are accompanied by an electric arc. An arc fault always leads to considerable damage to equipment and personnel unless it is distinguished very fast. The fault should be disconnected as fast as possible and in less than 0.1 s to avoid serious damages and give involved person a fair chance to survive the accident without severe damages. This is a demand found in the electrical safety rules in all CE countries, ref. IEC364-4-42.

The Arc Guard System TVOC-2 is an aid to quickly detect an arc fault and trip the incoming circuit-breaker. The main advantage with the Arc Guard System is that it can trip instantaneously, i.e. override other tripping functions.



### LV distribution

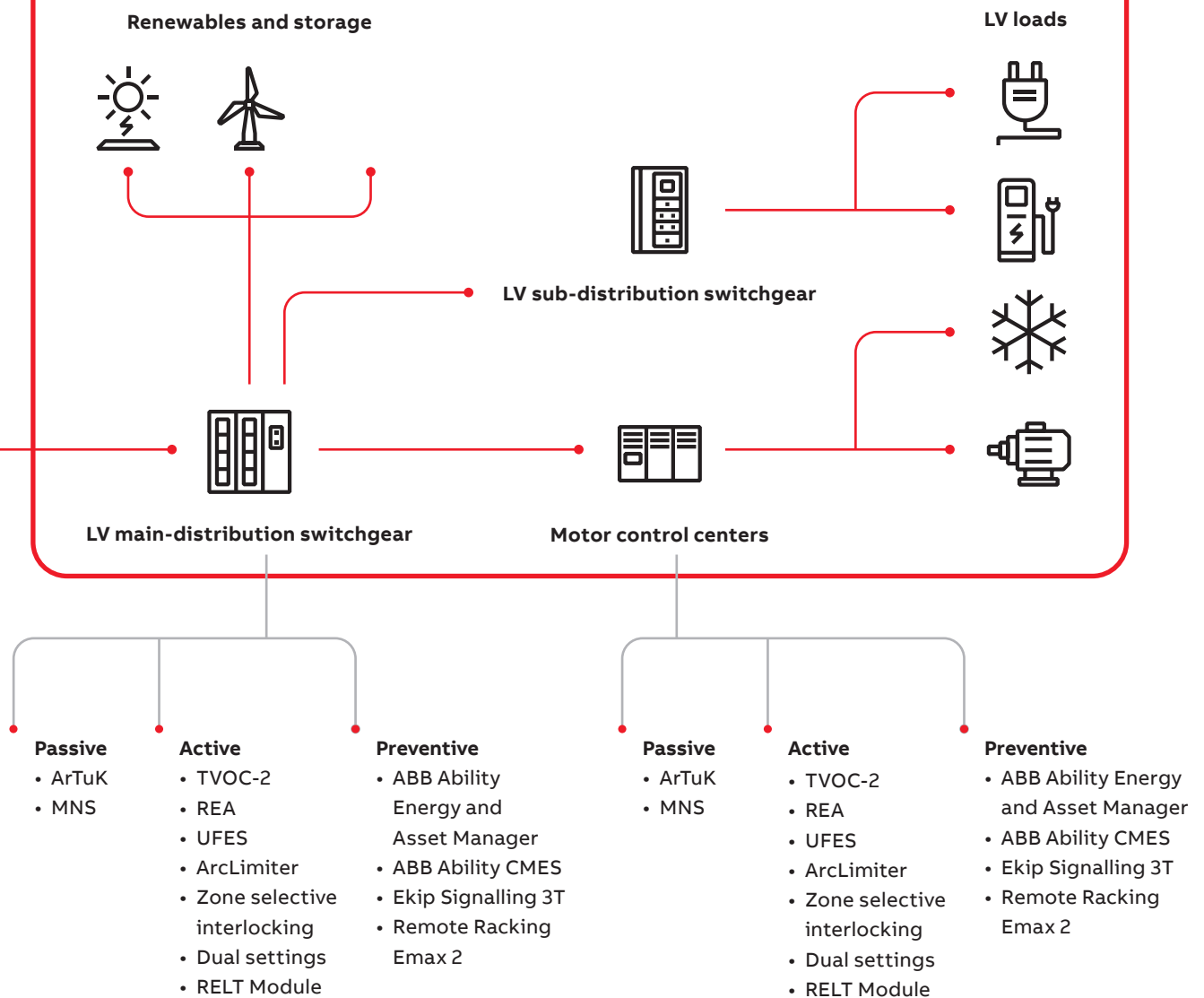

# Arc Guard System TVOC-2



Arc Monitor with COM Module

1SFCT70011V0001



Arc Monitor with HMI

1SFCT70014V0001



Extension unit

1SFCT70012F0001



COM Module

1SFCT70009V0001



HMI

1SFCT70012V0001



Detector cable

1SFCT70011F0001



CSU-2LV

1SFCT70008V0001

Ordering details				
Description	Rated supply voltage	Type	Ordering code	LP.(₹)
Arc Monitor including one HMI and door mounting accessories	24...48V DC	TVOC-2-48	1SFA664001R1002	Upon request
	100...240V AC/ 100...250V DC	TVOC-2-240	1SFA664001R1001	
Arc Monitor including one COM Module and door mounting accessories	24...48V DC	TVOC-2-48-C	1SFA664001R1004	
	100...240V AC/ 100...250V DC	TVOC-2-240-C	1SFA664001R1003	

Accessories				
Extension-10 optical inputs		TVOC-2-E1	1SFA664002R1001	Upon request
Extension-10 optical inputs for cable TVOC-2-DP60 only		TVOC-2-E3	1SFA664002R3001	
HMI (Human machine interface)		TVOC-2-H1	1SFA664002R1005	
COM Module-with communication interface (Modbus RTU) and door mounting		TVOC-2-COM	1SFA664002R4001	

Detector				
Cable length	1 m	TVOC-2-DP1	1SFA664003R1010	Upon request
Cable length	2 m	TVOC-2-DP2	1SFA664003R1020	
Cable length	4 m	TVOC-2-DP4	1SFA664003R1040	
Cable length	6 m	TVOC-2-DP6	1SFA664003R1060	
Cable length	8 m	TVOC-2-DP8	1SFA664003R1080	
Cable length	10 m	TVOC-2-DP10	1SFA664003R1100	
Cable length	15 m	TVOC-2-DP15	1SFA664003R1150	
Cable length	20 m	TVOC-2-DP20	1SFA664003R1200	
Cable length	25 m	TVOC-2-DP25	1SFA664003R1250	
Cable length	30 m	TVOC-2-DP30	1SFA664003R1300	
Cable length (1)	60 m	TVOC-2-DP60	1SFA664003R3600	

## Current sensing unit

**NEW**

Description	Type	Order code	Weight (1 pce) kg
Low voltage current sensing unit	CSU-2LV	1SFA664002R5001	0.420
Medium voltage current sensing unit	CSU-2MV	1SFA664002R8001	0.420

Diameter mm	Cable length	Type	Order code	Weight (1 pce) kg
-------------	--------------	------	------------	-------------------

## Rogowski coil current sensors for low voltage applications

120	5	RC120-05	1SFA664005R1205	0.180
	10	RC120-10	1SFA664005R1210	0.180
	15	RC120-15	1SFA664005R1215	0.570
200	30	RC120-30	1SFA664005R1230	1.030
	5	RC200-05	1SFA664005R2005	0.210
	10	RC200-10	1SFA664005R2010	0.210
	15	RC200-15	1SFA664005R2015	0.600
	30	RC200-30	1SFA664005R2030	1.050

Note: For medium voltage application, use KECA and KEVCD current sensors types.

Please consult <https://new.abb.com/medium-voltage/apparatus/instrument-transformers-and-sensors-id/products/sensors-new>

# Production-friendly safety systems from ABB Safety

**Quick-Guard fencing system**  
to prevent unauthorised access



**Contactors and electronic  
compacts starters**  
to control power and motors



**Inca emergency stop  
button**  
for compact panel  
mounting



**MKey9 key switch**  
for safe locking of hatches and doors

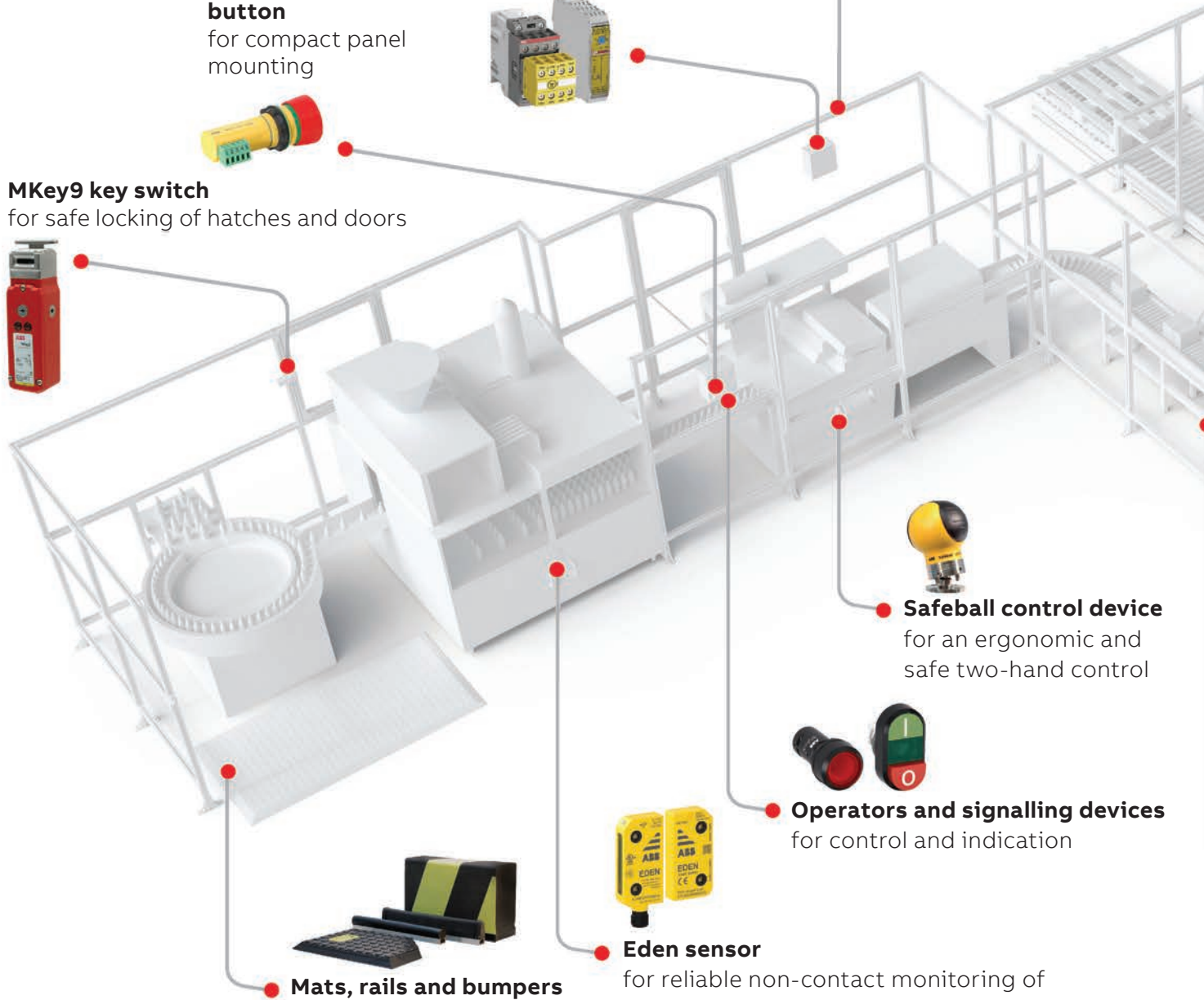

**Safeball control device**  
for an ergonomic and  
safe two-hand control



**Operators and signalling devices**  
for control and indication



**Eden sensor**  
for reliable non-contact monitoring of  
doors and hatches



**Mats, rails and bumpers**  
to detect the presence  
of people

**Magne magnetic lock**  
to keep doors and hatches  
locked during a process



**Pluto programmable safety controller, B&R X20 safety PLC,  
Vital safety controller and Sentry safety relays**  
for flexible monitoring of safety devices



**Smile emergency stop button**  
to safety stop machinery in hazardous  
situations



**Orion light guards**  
for a production friendly  
safety detection



**GKey safety lock**  
for safe locking of doors



**JSDH4 three-position device**  
for safe and ergonomic  
inspection and troubleshooting



**LineStrong pull wire  
emergency stop switch**  
for easy access of emergency stop  
function



# ABB safety

## Sentry safety relays

Expansion	Safety devices	Test/Reset	Safety relay outputs	Timer function	Feature	Power supply
Expansion of safety controller outputs	1 channel 2 channels with equivalent contacts 2 channels with antivalent contacts OSSD outputs / PNP outputs Contact mats, bumpers and safety edges <sup>c)</sup> Two-hand devices	Manual reset (all models have auto reset) Start/Test	3 NO + 1 NC 4 NO 2 NO + 2 delayed/delayable NO 4 NO + 1 NC	Off-delay 0.5 s Off-delay 1.5 s Advanced timer functions 0 – 999 s <sup>d)</sup>	Configurable with display	85-265 VAC / 120-375 VDC +24 VDC



						Type	Ordering code	L.P.(₹)
a)	● b)	●	●			BSR10	2TLA010040R0000	16,730
						BSR10P	2TLA010040R0001	17,510
a)	● b)	●	●			BSR11	2TLA010040R0200	16,730
						BSR11P	2TLA010040R0201	17,510
a)				●		BSR23 e)	2TLA010041R0600	14,570
						BSR23P e)	2TLA010041R0601	15,240
●	● ● ●	●	●			SSR10	2TLA010050R0000	20,550
						SSR10P	2TLA010050R0001	21,490
●	●	●	●			SSR10M	2TLA010050R0100	25,990
						SSR10MP	2TLA010050R0101	27,380
		●	●			SSR20	2TLA010051R0000	22,560
						SSR20P	2TLA010051R0001	23,600
		●	●			SSR20M	2TLA010051R0100	28,820
						SSR20MP	2TLA010051R0101	30,360
	● ● ●	●	●	●		SSR32	2TLA010052R0400	32,820
						SSR32P	2TLA010052R0401	34,550
	● ● ●	●	●	●		SSR42	2TLA010053R0400	32,820
						SSR42P	2TLA010053R0401	34,340
●	● ● ●	●	●	● ● ● ●	●	TSR10	2TLA010060R0000	26,380
						TSR10P	2TLA010060R0001	27,590
●	● ● ●	●	●	● ●		TSR20	2TLA010061R0000	26,380
						TSR20P	2TLA010061R0001	27,830
●	●	●	●	● ●	●	TSR20M	2TLA010061R0100	25,990
						TSR20MP	2TLA010061R0101	27,190
	● ● ● ● ● ●	●	●	● ● ● ●	●	USR10	2TLA010070R0000	31,320
						USR10P	2TLA010070R0001	32,760
	● ● ● ● ● ●	●	●	● ● ● ●	●	USR22	2TLA010070R0400	43,700
						USR22P	2TLA010070R0401	45,690

- a) These models can also be used for expansion of Pluto safe transistor outputs (-24 VDC)
- b) No monitoring of two-channel fault, i.e. max Category 3 without fault exclusion.
- c) The safety relay detects a short-circuit, not a change in resistance.
- d) Off-delay, On-delay, Time bypass or Time reset.
- e) BSR23 must be monitored by another device in order to reach higher than Category 1/PL c according to EN ISO 13849-1, for example a safety relay, a safety PLC or an Orion light guard (EDM function).
- f) push in version also available.
- g) Please contact your local sales of ABB.



### Safety controller

DYNlink circuits	Maximum DYNlink devices	Safe outputs	Type	Order code	L.P.(₹)
1	30	2 NO	Vital 1	2TLA020052R1000	39,790

## Programmable safety controller

Safety bus	Failsafe outputs a)	Failsafe inputs (max) b)	Analog inputs (max) b)	Fast counter inputs (max) b)	StatusBus inputs (max) b)	Non failsafe outputs (max) b)	Width mm	Type	Ordering code	L.P.(₹)
No	4	16	1 c)		4	8	45	Pluto S20	2TLA020070R4700	1,01,030
	6	40	3 c)		4	16	90	Pluto S46	2TLA020070R1800	1,43,540
Yes		22	1 c)		4	8	45	Pluto B22 e)	2TLA020070R4800	96,380
	2	4			2	2	45	Pluto O2 f)	2TLA020070R8500	87,200
	4	16	1 c)		4	8	45	Pluto A20 g)	2TLA020070R4500	1,38,150
								Pluto B20	2TLA020070R4600	1,27,050
			4 d) + 1 c)		4	8	45	Pluto D20	2TLA020070R6400	1,69,210
	6	40	3 c)		4	16	90	Pluto B46	2TLA020070R1700	1,69,210
		39	8 d)	4	4	15	90	Pluto D45	2TLA020070R6600	2,06,420

### a) Failsafe outputs

2 failsafe outputs:

- 2 independent individually safe potential free relay outputs (Q0 and Q1) with 3 contacts each

4 failsafe outputs:

- 2 independent individually safe potential free relay outputs (Q0 and Q1)
- 2 independent individually safe transistor outputs (-24 VDC) (Q2 and Q3)

6 failsafe outputs:

- 2 independent individually safe potential free relay outputs (Q0 and Q1)
- 2 independent individually safe potential free relay outputs with common supply (Q4 and Q5)
- 2 independent individually safe transistor outputs (-24 VDC) (Q2 and Q3)

- b) -The number of failsafe inputs available decreases with the number of used non-failsafe outputs, analog inputs, fast counter inputs and StatusBus inputs.  
 -The number of analogue inputs available decreases with the number of used fast counter inputs.  
 -The number of non-failsafe outputs available decreases with the number of StatusBus inputs used.  
 Check the Pluto hardware manual for more information.

c) 0-27 V analog inputs

d) 0-10 V/4-20 mA (high resolution) analog inputs

e) Expansion model with failsafe inputs and no failsafe outputs.

f) Expansion model with 2 failsafe outputs with 3 contacts each. Also possible to use as stand-alone unit.

g) Model with current monitoring

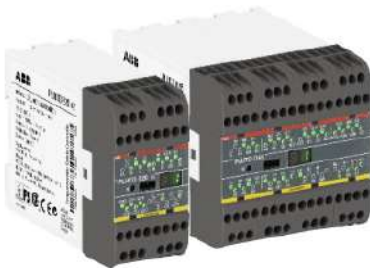

## Gateway for communication

Fieldbus	Ethernet	Type	Ordering code	L.P.(₹)
CANopen		GATE-C2	2TLA020071R8100	41,460
DeviceNet		GATE-D2	2TLA020071R8200	49,200
PROFIBUS-DP		GATE-P2	2TLA020071R8000	49,200
EtherCAT	X	GATE-EC	2TLA020071R9100	62,600
Ethernet/IP	X	GATE-EIP	2TLA020071R9000	61,780
Modbus TCP	X	GATE-MT	2TLA020071R9400	62,600
PROFINET	X	GATE-PN	2TLA020071R9300	62,600



## Safety and process locks

### Switches

Material (body)	Positions for pilot devices	Manual unlock	Type	Ordering code	L.P.(₹)
Die cast	4	Yes	GKey4 RU	2TLA050304R0002	1,09,230



### Mounting plate with front handle

Type of handle	Material (mounting plates and sliding bolt)	Type	Ordering code	L.P.(₹)
Sliding	Die cast	FHS GKey4	2TLA050310R0032	34,790

### Accessories - Rear handle and spring loaded catch

Type of handle	Material	Description	Type	Ordering code	L.P.(₹)
Sliding	Die cast	Rear handle	RHS GKey MKey	2TLA050040R0510	3,590
		Spring catch	SCS GKey MKey	2TLA050040R0511	3,590

### Safety light curtains/Grids

Detection (Resolution mm)	Protected height mm	Type (Transmitter + receiver)	Ordering code	L.P.(₹)
Finger (14)	150	Orion1-4-14-015-B	2TLA022300R0000	1,00,300
	450	Orion1-4-14-045-B	2TLA022300R0200	1,79,080
	750	Orion1-4-14-075-B	2TLA022300R0400	2,52,980
	1050	Orion1-4-14-105-B	2TLA022300R0600	3,25,220
	1200	Orion1-4-14-120-B	2TLA022300R0700	3,62,440
	1050	Orion1-4-14-105-E	2TLA022301R0600	4,02,970
	1200	Orion1-4-14-120-E	2TLA022301R0700	4,42,660
	1500	Orion1-4-14-150-E	2TLA022301R0900	5,30,990
Hand (30)	450	Orion1-4-30-045-B	2TLA022302R0200	1,31,060
	750	Orion1-4-30-075-B	2TLA022302R0400	1,69,050
	1050	Orion1-4-30-105-B	2TLA022302R0600	2,07,870
	1200	Orion1-4-30-120-B	2TLA022302R0700	2,30,220
	1500	Orion1-4-30-150-B	2TLA022302R0900	2,68,350
	1800	Orion1-4-30-180-B	2TLA022302R1100	3,09,150
	1050	Orion1-4-30-105-E	2TLA022303R0600	2,84,890
	1200	Orion1-4-30-120-E	2TLA022303R0700	3,07,700
	1500	Orion1-4-30-150-E	2TLA022303R0900	3,67,250
	1800	Orion1-4-30-180-E	2TLA022303R1100	4,27,780



\*\*Note:- for other variants please contact Local Sales of ABB.





### Orion 2 Base/Extended

Detection	Protected height mm	Type (Transmitter + receiver)	Ordering code	L.P.(₹)
Body	900 (4 beams)	Orion2-4-K2-090-B	2TLA022304R0200	1,42,890
	1200 (4 beams)	Orion2-4-K4-120-B	2TLA022304R0300	1,58,740
Body	500(2 beams)	Orion2-4-K2-050-E	2TLA022305R0000	1,24,550
	800 (3 beams)	Orion2-4-K2-080-E	2TLA022305R0100	1,46,000
	900 (4 beams)	Orion2-4-K2-090-E	2TLA022305R0200	1,64,340
	1200 (4 beams)	Orion2-4-K2-120-E	2TLA022305R0300	1,82,560



### Orion 3 Base/Extended

Detection	Protected height mm	Active or passive Part	Type	Ordering code	L.P.(₹)
Body	500 (2 beams)	Active part	Orion3-4-K1C-050-B	2TLA022306R0000	70,890
		Passive part	Orion3-4-M1C-050	2TLA022306R1000	27,400
	800 (3 beams)	Active part	Orion3-4-K2C-080-B	2TLA022306R0100	93,150
		Passive part	Orion3-4-M2C-080	2TLA022306R1100	37,680
Body	900 (4 beams)	Active part	Orion3-4-K2C-090-B	2TLA022306R0200	1,02,050
		Passive part	Orion3-4-M2C-090	2TLA022306R1300	41,090
	1200 (4 beams)	Active part	Orion3-4-K2C-120-B	2TLA022306R0300	1,08,550
		Passive part	Orion3-4-M2C-120	2TLA022306R1400	52,060
Body	500 (2 beams)	Active part	Orion3-4-K1C-050-E	2TLA022307R0000	91,430
		Passive part	Orion3-4-M1C-050	2TLA022306R1000	27,400
	800 (3 beams)	Active part	Orion3-4-K2C-080-E	2TLA022307R0100	1,11,640
		Passive part	Orion3-4-M2C-080	2TLA022306R1100	37,680
	900 (4 beams)	Active part	Orion3-4-K2C-090-E	2TLA022307R0200	1,20,880
		Passive part	Orion3-4-M2C-090	2TLA022306R1300	41,090
	1200 (4 beams)	Active part	Orion3-4-K2C-120-E	2TLA022307R0300	1,32,520
		Passive part	Orion3-4-M2C-120	2TLA022306R1400	52,060

\*\*Note:- for other variants please contact Local Sales of ABB.

### Safeball JSTD1

Types of switches	Cable length	Type	Ordering code	L.P.(₹)
1 NO + 1 NC	2 m	JSTD1-A	2TLA020007R3000	17,780
	0.2 m	JSTD1-B	2TLA020007R3100	14,430
	10 m	JSTD1-C	2TLA020007R3200	21,650
2 NO	0.2 m	JSTD1-E	2TLA020007R3400	14,110

### Two-hand control devices JSTD25

Extra feature	Connector male	Type	Ordering code	L.P.(₹)
None	M12-5	JSTD25F	2TLA020007R6000	50,760
	M12-8	JSTD25H	2TLA020007R6300	60,110
Pre-mounted Smile 10 EK emergency stop button	M12-8	JSTD25K	2TLA020007R6900	68,660

### Accessories

Description	Type	Ordering code	L.P.(₹)
Mounting bracket for JSTD1 with orientation possibility (ball joint)	JSM C5	2TLA020007R0900	7,170
Suspension shelf for JSTD25F/H/K	JSM C7	2TLA020007R1200	7,630
coat for Safeball	Safeball coat	2TLA020007R1900	3,810

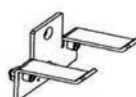

## Three positional safety device Complete list of JSHD4 models



Top Part Buttons and LEDs	Bottom part Feature	ID	Connection	Anti-tamper	Type	Ordering code	L.P.(₹)
JSHD4-1	Use your own cable	AA	Cable gland and 5 screw connections		JSHD4-1-AA	2TLA019995R0000	35,510
No LEDs No buttons	Cost effective and quick connection	AC	M12-5 male		JSHD4-1-AC	2TLA019995R0100	39,920
JSHD4-2	Cost effective and robust	AB	Cannon 12 male pins		JSHD4-2-AB	2TLA019995R0200	50,690
	Use your own cable, full pin connection	AJ	Cable gland and 16 screw connections	●	JSHD4-2-AJ-A	2TLA019995R1100	68,570
	Replacement of old units*	AK	Cannon 12 male pins		JSHD4-2-AK	2TLA019995R4800	48,490

## HD5 ordering information



Emergency stop with LED	Home position sensor	Motion sensor	LED flashlight	Connector	Two top	Type	Ordering code	L.P.(₹)
No	No	No	No	M23-12	No	HD5-S-102	2TLA023001R0000	83,260
					Yes	HD5-S-104	2TLA023001R0200	97,950
Yes	Yes	Yes	Yes	M23-19	Yes	HD5-S-111	2TLA023001R0100	1,46,920

## HD5 accessories



Description	Suitable for	Type	Ordering code	L.P.(₹)
Active holder (for home position sensor)	All models	HD5-M-001	2TLA920509R0001	5,900
Passive holder	All models	HD5-M-002	2TLA920509R0002	4,890
10 m cable with M23-12 female connector	HD5-S-102/104	JSD-TK10-12	2TLA930051R0000	45,900
5 m cable with M23-12 female connector	HD5-S-102/104	JSD-TK5-12	2TLA930050R0000	35,080
10 m spiral cable with M23-12 female connector	HD5-S-102/104	JSD-TK100S-12	2TLA930034R0000	84,090

## Emergency Stop Sign

### Panel mounting



IP rating	Depth	Connection type	Type of safety signal	Feature	Type	Ordering code	L.P.(₹)
IP65	26 mm	1 x M12-5 male	DYNlink	Status LED	Smile 11 EAR Tina	2TLA030050R0100	13,710
			2 NC	Status LED	Smile 11 EAR	2TLA030051R0100	11,920
			DYNlink	Status LED	INCA 1 Tina	2TLA030054R0000	14,350
Button IP65, connector IP20	53 mm	Removable terminal block		Status LED, StatusBus	INCA 1 EC Tina	2TLA030054R1400	16,010
			2 NC	Status LED	INCA 1	2TLA030054R0100	12,810

# ABB safety

## Emergency Stop Button External mounting



Description	Type of safety signal	Connection type	Feature	Type	Ordering code	L.P.(₹)
Compact size Plastic housing IP65	DYNlink	1 m cable from bottom 1 x M12-5 male 1 x M12-5 male 2 x M12-5 male	Status LED	Smile 10 EA Tina	2TLA030050R0400	13,840
			Status LED	Smile 11 EA Tina	2TLA030050R0000	13,320
			Status LED, StatusBus	Smile 11 EC Tina	2TLA030050R0900	14,600
			Status LED	Smile 12 EA Tina	2TLA030050R0200	14,480
Plastic housing IP66, IP67 and IP69K	2 NC	1 m cable from bottom 1 m leads from bottom 1 x M12-5 male 2 x M12-5 male	Status LED	Smile 10 EA	2TLA030051R0400	12,050
			-	Smile 10 EK	2TLA030051R0600	8,970
			Status LED	Smile 11 EA	2TLA030051R0000	11,530
			Status LED	Smile 12 EA	2TLA030051R0200	12,680
Plastic housing IP66, IP67 and IP69K	2 NC*	2 x M20 conduits	-	CEPY1-1002 (Compact)	1SFA619821R1002	4,540
			With shroud	CEPY1-2002 (Compact)	1SFA619821R2002	4,870
Metal housing IP67 and IP69K	2 NO + 2 NC	3 x M20 conduits	Status LED	EStrongZ LED	2TLA050220R0222	34,570
			-	EStrongZ	2TLA050220R0020	31,240

\* Can be adapted to DYNlink with Tina

## Emergency stop grab wire safety switch



IP rating	Material	E-stop button	Contacts	Max. wire length (m)		Feature	Type	Ordering code	L.P.(₹)
				1 unit	2 units				
IP67	Yellow die cast aluminum alloy	No	2 NO + 2 NC	30	50	-	LineStrong1	2TLA050200R0030	22,880
				60	80	-	LineStrong2	2TLA050202R0332	32,650
		Yes	2 NO + 4 NC	100	125	Left hand	LineStrong3L	2TLA050206R0332	41,450
						Right hand	LineStrong3R	2TLA050208R0332	41,450
						Both sides	LineStrong3D	2TLA050204R0332	62,800
2 NO + 2 NC	80	100	-	LineStrong2Z	2TLA050202R0322	67,820			
IP67, IP69K	Stainless steel 316	Yes	2 NO + 4 NC	100	125	Left hand	LineStrong3LZ	2TLA050206R0322	79,130
						Right hand	LineStrong3RZ	2TLA050208R0322	79,130
						Both sides	LineStrong3DZ	2TLA050204R0322	1,00,470

## Safety bumper -ASB



Overtravel <sup>a)</sup> mm	Description	Material	Type	Ordering code	L.P.(₹)
60	60x100 mm bumper. Length in m needs to be specified on order.	Imitation leather	Bumper ASB 60-100 black/ yellow	2TLA076200R0500	Upon request
120	100x200 mm bumper. Length in m needs to be specified on order.	Imitation leather	Bumper ASB 100-200 black/yellow	2TLA076200R0600	
180	150x300 mm bumper. Length in m needs to be specified on order.	Imitation leather	Bumper ASB 150-300 black/yellow	2TLA076200R0700	
240	200x400 mm bumper. Length in m needs to be specified on order.	Imitation leather	Bumper ASB 200-400 black/yellow	2TLA076200R0800	

<sup>a)</sup> 60% of bumper height at 10 mm/s

## Production cost and cables

Description	Type	Ordering code	L.P.(₹)
Bumpers production cost, including aluminum rail and cables	Bumper production cost	2TLA076200R0000	Upon request



## Safety mat ASK – standard sizes

Size mm	Description	Connectors	Type	Ordering code	L.P.(₹)
750x1000	750x1000 safety mat with molded ramp rail and two 5 m cables	1x M8 male 1x M8 female	Safety mat ASK T4 750x1000mm	2TLA076310R1000	Upon request
1000x1000	1000x1000 safety mat with molded ramp rail and two 5 m cables	1x M8 male 1x M8 female	Safety mat ASK T4 1000x1000mm	2TLA076310R1100	
1000x1500	1000x1500 safety mat with molded ramp rail and two 5 m cables	1x M8 male 1x M8 female	Safety mat ASK T4 1000x1500mm	2TLA076310R1200	

## Safety mat ASK – custom sizes

Description	Connectors	Type	Ordering code	L.P.(₹)
Base price for custom made safety mat with molded ramp rail	–	Safety mat ASK CM T4, base price	2TLA076301R0200	Upon request
Order code for size (m2) and two 5 m cables. Specify dimensions (width x length in mm) in text.	1x M8 male 1x M8 female	Safety mat ASK CM T4	2TLA076301R0600	

## Safety edge TT

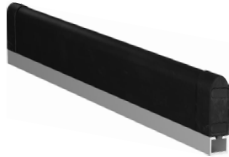

Overtravel <sup>a)</sup> mm	Description	Material	Type	Ordering code	L.P.(₹)
15	30 mm high safety edge with 25-14 aluminum rail. Length in m needs to be specified on order.	TPE	Safety edge TT 25-30 TPE	2TLA076025R3010	Upon request
22.7	45 mm high safety edge with 25-14 aluminum rail. Length in m needs to be specified on order.	TPE	Safety edge TT 25-45 TPE	2TLA076025R4510	

## Production cost and cables

Length of cables m	Description	Type	Ordering code	L.P.(₹)
2.5	Production cost with a 2,5 m cable in each end.	Safety edge production cost 2,5m cable	2TLA076010R0100	Upon request
5	Production cost with a 5 m cable in each end.	Safety edge production cost 5,0m cable	2TLA076010R0500	
10	Production cost with a 10 m cable in each end.	Safety edge production cost 10,0m cable	2TLA076010R1000	

## Eden sensors

### Eva



Code description	Code level	Type	Ordering code	L.P.(₹)
General code. (Eva is interchangeable)	Low level	Eva General code	2TLA020046R0800	2,910
Unique code. (Prevents defeat/fraud)	High level	Eva Unique code	2TLA020046R0900	4,940

### Adam

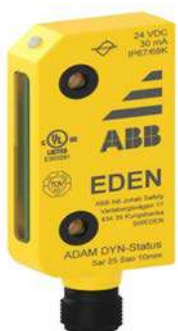

Type of safety controller	Status Bus	Info signal	Local reset	Series connection	Connector male	Type	Ordering code	L.P.(₹)
Pluto	x	x <sup>1)</sup>	x	x	M12-5	Adam DYN-Status M12-5	2TLA020051R5200	10,890
Pluto or Vital		x		x	M12-5	Adam DYN-Info M12-5	2TLA020051R5100	9,590
			x	x	M12-5	Adam DYN-Reset M12-5	2TLA020051R5300	12,680
OSSD compatible (incl. Pluto and Sentry)		x			M12-5	Adam OSSD-Info M12-5	2TLA020051R5400	8,260
			x		M12-5	Adam OSSD-Reset M12-5	2TLA020051R5600	11,200
		x	x	x	M12-8	Adam OSSD-Reset M12-8	2TLA020051R5900	13,710

## MKey ordering information

Locking function	Material housing	Material head	Holding force	Special feature	Type	Ordering code	L.P.(₹)
—	Plastic	Plastic	12 N		MKey5	2TLA050003R0100	6,810
			40 N		MKey5+	2TLA050003R0101	7,520
	Stainless steel	Stainless steel	12 N		MKey5 SSH	2TLA050003R0110	9,630
			40 N		MKey5+ SSH	2TLA050003R0111	10,680
Process lock (power to lock)	Plastic	Stainless steel	12 N	IP69K	MKey5Z	2TLA050003R0120	27,730
			40 N	IP69K	MKey5+Z	2TLA050003R0121	31,500
	Die cast	Die cast	1800 N		MKey9M 24VDC	2TLA050009R0112	37,130
			2000 N		MKey8M 24VDC	2TLA050013R0132	51,720
Safety lock (power to unlock)	Plastic	Stainless steel	1800 N		MKey9 24VDC	2TLA050007R0112	34,590
				No key supplied	MKey9 24VDC, No Key	2TLA050007R0012	33,800
	Die cast	Die cast	2000 N		MKey8 24VDC	2TLA050011R0132	47,890
				With escape release button	MKey8ER 24VDC	2TLA050015R0132	68,100
	Stainless steel	Stainless steel	2000 N	IP69K	MKey8Z 24VDC	2TLA050011R0122	75,530





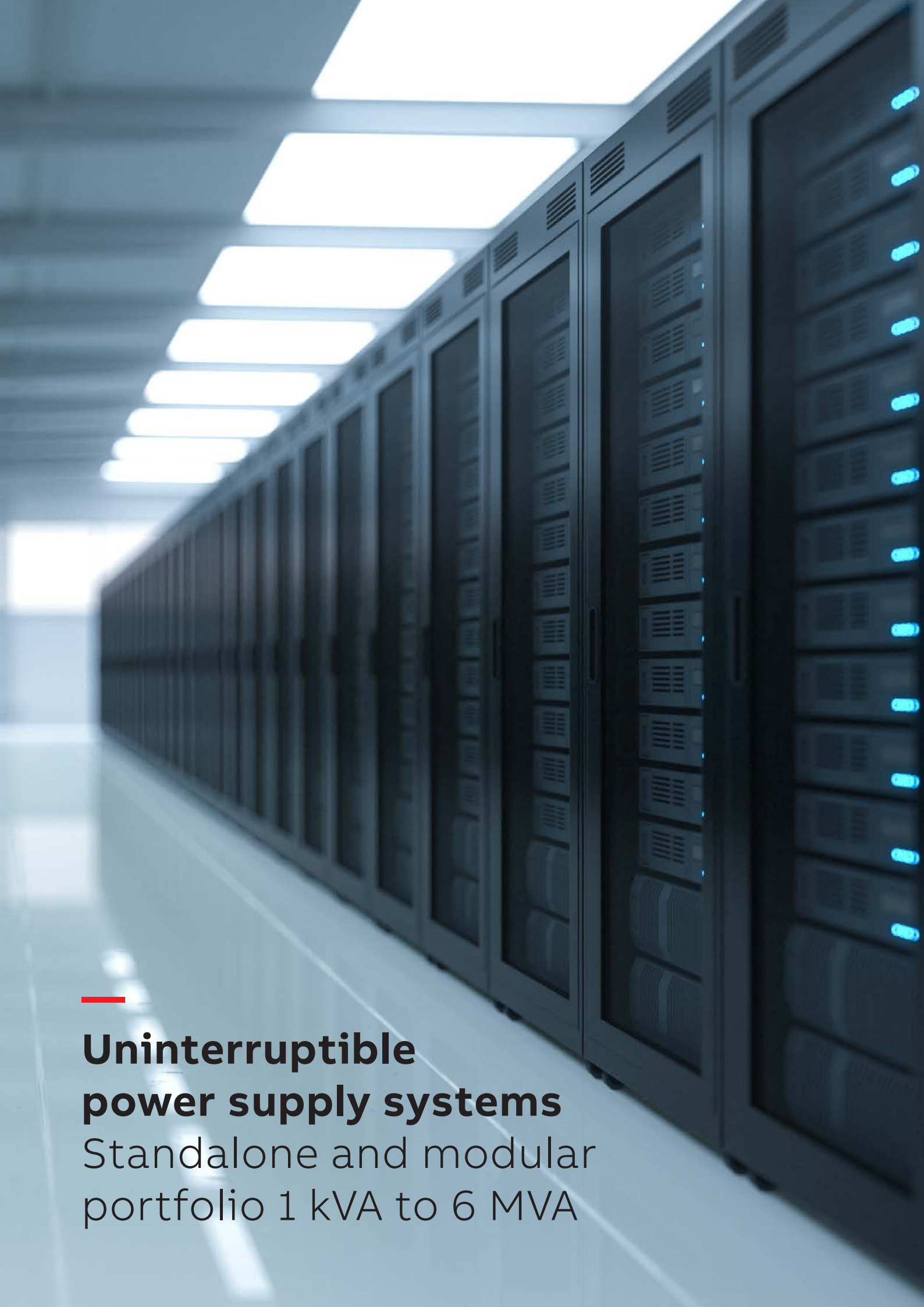

—

## **Uninterruptible power supply systems**

Standalone and modular  
portfolio 1 kVA to 6 MVA

# ABB's UPS manufacturing principles

In ABB, quality is an integral part of our business ethos. Quality guides our actions to ensure we meet our responsibilities and obligations to our customers, our employees, our partners, our suppliers and to our shareholders.

## ABB's commitment to deliver high quality

- Deliver on-time and on-quality products, systems and services that meet or exceed our customers' expectations.
- Identify and understand our customer's expectations, measure customer perceptions and implement improvements to increase customer satisfaction.
- Enable and engage our employees at all levels in a relentless drive to improve operational performance along the value chain from suppliers to customers.
- Increase the motivation and skills of our employees to add value to our customers and our businesses through continual training and development.
- Leverage our partners' and suppliers' strengths to improve our products and our businesses from product design through production, installation and operation.
- Embed social responsibility and company ethics policies in our business practices.
- Continually improve environmental, health and safety performance through all products, operations, systems and services.

## Manufacturing

Quality in manufacturing begins with the order from the customer. We practice made-to-order manufacturing – a lean approach that exploits just-in-time supply and that treats each and every customer order as a single, valuable entity. Each product is individually tested before leaving the factory with a 100 percent pretest on modules individually and a 100 percent final test on modular and standalone UPSs.

**Quality only becomes quality when it is measured and for this reason we employ key performance indicators (KPIs) some of which are:**

- Safety
- Quality from the suppliers (part-per-million defect rates and on-time delivery)
- Quantity of products / items produced for new business and for service departments (after sales)
- Internal first-pass yield
- On-time delivery of the finished product

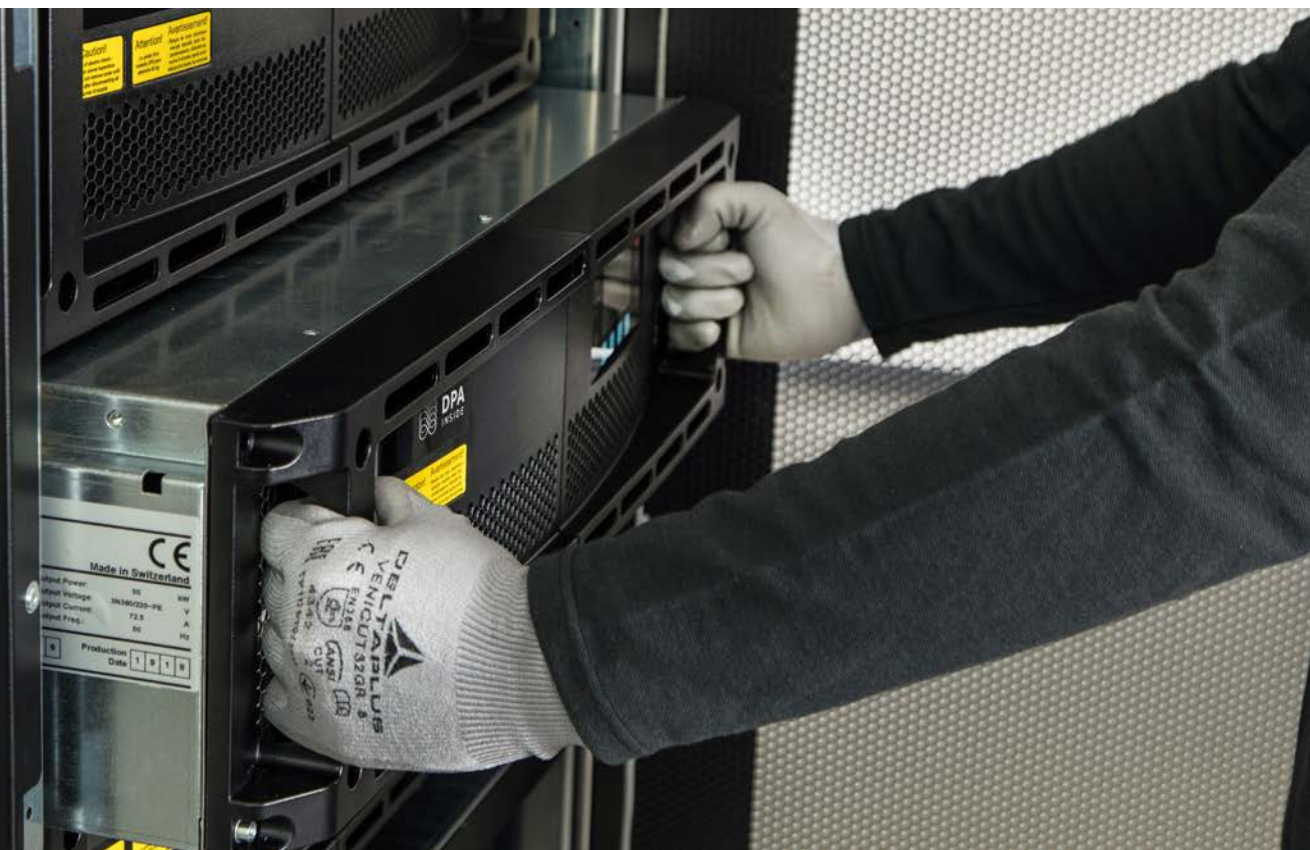



### Product quality assurance

In ABB, we believe in getting it right the first time – and keeping it that way. For that reason, we engage in component homologation as well as the identification of critical components. Suppliers are fully vetted and qualified, on an ongoing basis, and our test verification plan and type testing assures our quality standards even further.

The ABB product development gate model is deployed all the way through to product launch – from initial conception through development to final full release, and after – right up to gate seven. The gate model involves every part of the organization and this ensures that every aspect of the new product is covered, guaranteeing the very best quality.

Should non-conformities arise, ABB has a comprehensive set of monitoring tools with which to examine the issue. This is backed up by a three-level support model:

- **Level 1:** solving problems in the field
- **Level 2:** statistical analysis and mitigation action definition
- **Level 3:** root cause analysis



—  
01

### Environmentally friendly

ABB has stated policies that drive the company to be as environmentally friendly as possible. One example of this is our product test bay used for all UPS final testing, which features an energy recovery system. This so-called GREEN (Generating Recycled Ecological Energy Network) test bay is a facility that recycles the greater part of the energy used during a UPS test. Only nine percent of the energy used is from the mains; 91 percent is recovered energy. This re-use is far more beneficial than having a traditional resistor load that merely turns the energy into heat, thus wasting it.

Further, the modern ABB building has an efficient heating / cooling system (energy management) as well as strict rules for recycling and managing discards.

### Certification

Product certification

- Accredited third-party certification:

	UPS standards	Low-voltage devices standards
Safety	IEC / EN 62040-1	IEC / EN 60950-1
EMC	IEC / EN 62040-2	IEC / EN 61000-6-2
		IEC / EN 61000-6-4
		IEC / EN 61000-4-2
		IEC / EN 61000-4-3
		IEC / EN 61000-4-4
		IEC / EN 61000-4-5
		IEC / EN 61000-4-6
Performance	IEC / EN 62040-3	
Environmental aspects	IEC / EN 62040-4	

### Factory certification

- ISO 9001 and 14001
- OHSAS18001

# ABB's modular UPS design

## Ensuring high availability and best-in-class power technology

01 In DPA, each UPS module has all the hardware and software it needs for autonomous operation.

### ABB's approach to modular power protection

Despite all the precautions taken during the design and operation of data centers and related control processes, situations can arise in which external power is compromised – either in terms of quality or availability. Such events could result in data loss, nonavailability of essential services, risk to hardware and very high financial losses. This makes a highly dependable UPS mission-critical. Therefore, the most critical loads should be protected by the very best UPS design – Decentralized Parallel Architecture (DPA™).

ABB, a pioneer and leader in large, modular UPSs, provides a full range of modular DPA power protection products as well as standalone solutions. In the following four pages, we will focus on our approach to modular power protection and describe how these modular solutions can help ensure a supply of clean, reliable power to the customer's application.

### DPA architecture

Key benefits

- Distributed control and power
- No single point of failure
- Independent online swappable modules

In DPA, each UPS module contains all the hardware and software required for full UPS system operation. Modules share no common components and each module is a fully functional UPS, so a DPA parallel system offers extremely high system reliability and uptime is maximized. UPS modules

can be paralleled to provide redundancy or to increase the system's total capacity.

Some modular UPS systems with a centralized parallel architecture (CPA) have centralized control or hardware. This renders them very vulnerable should a fault occur on one of these centralized components; one fault can bring down the entire UPS system.

With DPA, on the other hand, the UPS is modularized and each module has all the hardware and software needed for autonomous operation – rectifier, inverter, battery converter, static bypass switch, back-feed protection, control logic, display, and mimic diagram for monitoring and control. With all the critical components duplicated and distributed between individual units, potential single points of failure are eliminated. In the unlikely event of one UPS module failing, the failed module will be automatically isolated and the overall system will continue to operate normally.

### Modular UPS with no common components (Decentralized Parallel Architecture)

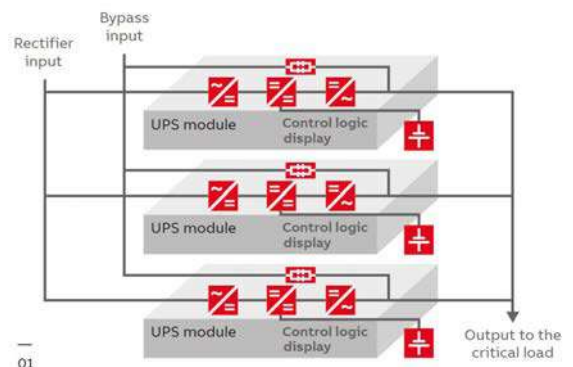

### Online swappable modules (OSM)

#### Key benefits

- Replace or add modules with no downtime
- Simple power upgrade
- No downtime during maintenance

True “online-swap” modularity enables the safe removal and insertion of UPS modules without risk to the critical load and without the need to either transfer it onto raw mains or remove power from it. Modules can therefore be replaced or added without any system downtime. It is simple to upgrade power capability as critical load power requirements grow. Additionally, modules can easily be removed for service or replaced if faulty, without compromising the availability of the system. Only a truly redundant architecture like DPA allows online modules to be swapped out while the system is running.

This unique aspect of modularity directly addresses continuous uptime requirements, significantly reduces mean time to repair (MTTR), reduces inventory levels of spare parts and simplifies system upgrades. This approach pays off too when it comes to serviceability and availability, as there is no downtime and the service personnel do not need special skills.

### Scalability

#### Key benefits

- Vertical and horizontal scalability
- Cost-effective “rightsizing”
- Easy configuration and reconfiguration

The ability to scale the system means the UPS can be sized exactly to fit prevailing needs and modules can simply be added as requirements grow. This means that you only power, cable and cool what you need.

The DPA 500, for example, allows five 100kW modules to be mounted in one cabinet and six cabinets to be configured in parallel to provide a top rating of 3MW. Power consumption is the topic of greatest concern for data center operators and the energy savings made by this modular approach over the service life time of the UPS are substantial. Human error is reduced too: Because things are so simple, wiring errors are eliminated, and configuration and reconfiguration are child’s play.

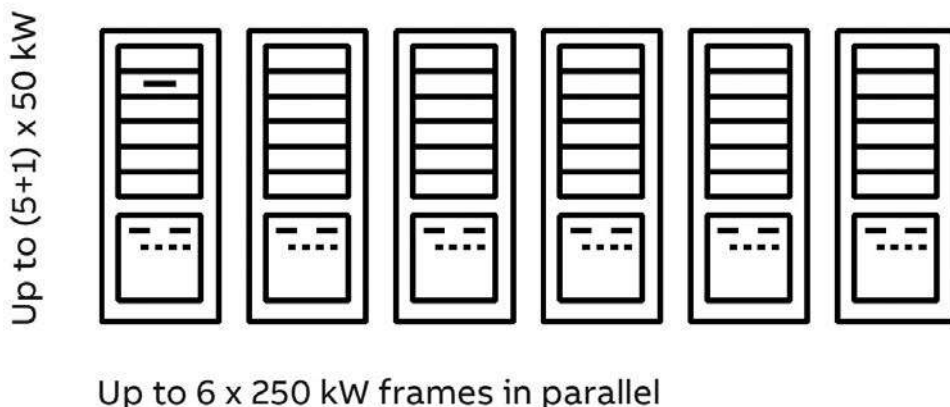

# ABB's modular UPS design

## Ensuring high availability and low total cost of ownership

### Availability

#### Key benefits

- 99.9999% (6 nines) availability

By combining the benefits of Decentralized Parallel Architecture, parallel redundancy and online swap modularity, ABB's UPSs have a high mean time between failure (MTBF) and a low mean time to repair (MTTR). This delivers six nines availability – a highly desirable quality required by data centers in pursuit of zero downtime.

The surest way to increase availability of power is to introduce redundancy to the UPS system and to minimize its maintenance and repair time. MTBF and MTTR are common parameters in the UPS industry and both impact system availability. Availability is formally defined as:  
$$\text{MTBF} / (\text{MTBF} + \text{MTTR}) \times 100\%$$

The modular DPA concept allows the modules to work as one system but without interdependence. Quick and simple repair by swapping modules, which can be held as spares on-site or at a nearby service center, minimizes the system's MTTR.

### Low total cost of ownership

#### Key benefits

- Over 97% true online efficiency
- Eco-mode efficiency  $\geq 99\%$
- Cost-effective scalability to "right size" system
- Low service costs

The modularity and scalability described help minimize the cost of ownership, but costs are held down too by implementing designs that have best-in-class energy efficiency.

ABB's DPA 250 S4, for example, operates with an efficiency of over 97 percent. Its efficiency curve is very flat so there are significant savings in every working regime. Further energy savings can be made by operating the UPS in eco-mode, which increases the efficiency to  $\geq 99$  percent.

### Online double conversion efficiency

#### Efficiency

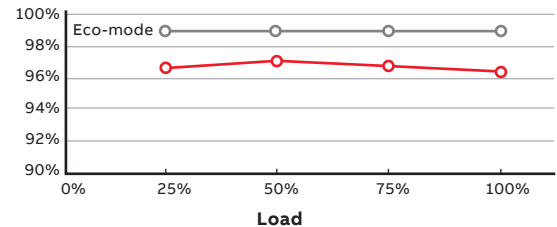

01 Example of a changing (increasing) load up to 120kW in 4 years.

02 Vertical modularity minimizes space requirements and maximizes predictability of future space requirements. In the example shown, 2m<sup>2</sup> is saved.

**The UPS capacity can be changed with changing load, eliminating the need to oversize the UPS upfront.**

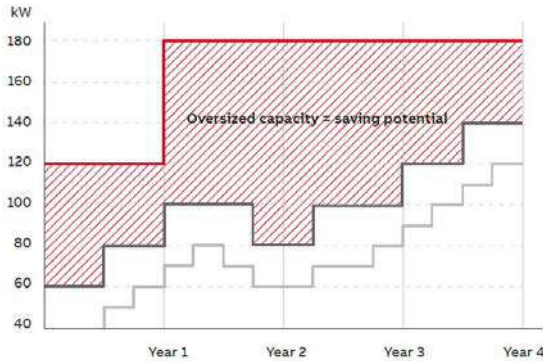

- **Standalone solution**  
2 × 60 kW (N+1) UPS until year 1  
3 × 60 kW (N+1) UPS years 1–4
- Oversized capacity
- **Modular solution**  
20kW UPS modules can be added or removed at any time according to the actual need.

Typical 4-year-load curve of a medium-sized data center

Modularity lends itself well to keeping UPS footprint small, too – ideal for data centers, where real estate can be restricted and expensive. A modular UPS rack has a small footprint and when extra modules are added, no extra floor space is taken up.

But the advantages of DPA modularity go further as installation and servicing costs are also kept low: A straightforward modular concept simplifies and speeds every step of the deployment process – from planning, through installation and commissioning to full use. DPA modularity also reduces costs as service engineers need less training and spend less time on-site, and any risks of data or production loss are minimized. Inventory levels of spare parts are reduced.

Highly dependable UPSs are mission-critical for many parts of industry. DPA delivers unmatched UPS availability and serviceability, scalability, flexibility and low energy usage.

There are no better UPS architectures available to those users whose critical electrical loads represent a valuable commercial asset that must be kept powered at all costs.

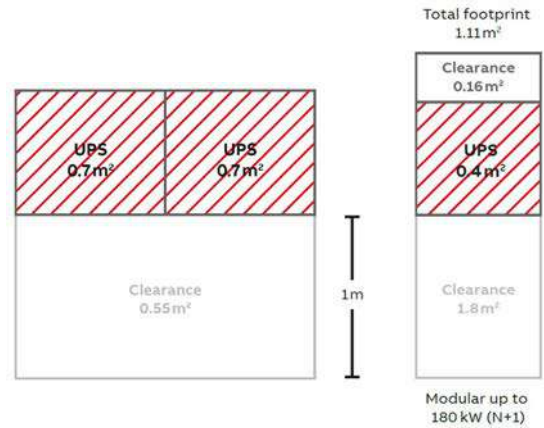

02

# UPS product overview

## 1 kVA to 10 kVA

### Single phase UPS



GENERAL DATA	PowerValue 11T	Powervalue 11 RT G2 IN
UPS frame rated power	1 / 2 / 3 / 6 /10 kVA	1 / 2 / 3 / 6 / 10 kVA
UPS module rated power	–	–
UPS output rated PF	0.9	1.0
Max. no of parallel frames	–	Up to 4 units (6 - 10kVA)
Max no of parallel modules across frames	–	
Max system power	10 kW	40 kW
Wiring	1-ph + N + PE	1-ph +N+PE
UPS type	<b>Standalone tower</b>	<b>Rack or tower convertible</b>
Topology	Online double conversion	Online double conversion
INPUT		
Nominal input voltage	220/230/240 VAC (1–3 kVA) 208/220/230/240 VAC (6–10 kVA)	208, 220, 230, 240 VAC
Voltage range	100–300 VAC (1–3 kVA) 110–300 VAC (6–10 kVA)	120–300 VAC (1–3 kVA) 100–276 VAC (6–10 kVA)
Frequency range	45–55 Hz (1–3kVA) 46–54 Hz (6–10kVA)	45–55 Hz
Current THD at 100% load	12% with full resistive load (1–3 kVA) < 5% with full resistive load (6–10 kVA)	< 5%
Power factor at 100% load	≥0.95 (1–3 kVA) ≥0.99 (6–10 kVA)	≥ 0.99
OUTPUT		
Rated output voltage (load dependent)	220/230/240 VAC (1–3 kVA) 208/220/230/240 VAC (6–10 kVA)	
Voltage THD (with linear load)	< 3% linear load, < 6% non linear load (1–3 kVA) < 3% linear load, < 5% non linear load (6–10 kVA)	< 2% linear load, < 5% non linear load (1–3 kVA) < 2% linear load, < 4% non linear load (6–10 kVA)
Rated frequency	50 Hz	50 Hz
EFFICIENCY		
Line-interactive	–	–
Double conversion	Up to 90%(1-3 kVA) 92% for 6 kVA 93% for 10 kVA	Up to 92% (1–3 kVA); 94% (6–10 kVA)
Eco-mode	Up to 95% (1–3 kVA) Up to 98% (6–10kVA)	Upto 98%
COMMUNICATIONS		
User Interface	LCD	LCD
Communication ports	SNMP; ModBus; AS400; Environmental monitoring sensor probe	USB, RS-232, SNMP slot, potential-free contacts
Software	Monitoring and shutdown software available as option	

# UPS product overview

## 10 kVA to 5 MVA

### 3 Phase Standalone UPS



GENERAL DATA	PowerScale 33 (Transformerless)	PowerWave 33 (Transformerless)	SG Series (Transformer based)
UPS frame rated power	10/15/20/25/30/40/50 kVA	60/80/100/120/160/200/ 250/300/400/500 kW	10–500 kVA
UPS module rated power	–	–	–
UPS output rated PF	0.9	1.0	0.9
Max. no of parallel frames	Up to 20 units	Up to 10 units	Up to 6 units
Max no of parallel modules across frames	–	–	–
Max system power	1000 kVA	5000 kW	3000 kVA
Wiring	3ph + N + PE	3ph + N + PE	3ph + N + PE
UPS type	Standalone tower	Standalone tower	Standalone tower
Topology	Online double conversion	Online double conversion	Online double conversion
<b>INPUT</b>			
Nominal input voltage	220 / 380, 230 / 400, 240 / 415 VAC	220 / 380, 230 / 400, 240 / 415 VAC	380/400/415 VAC 340–460 VAC
Voltage range	161/280 – 264/460 VAC	138/240 – 264/460 VAC	340–460 VAC
Frequency range	35 – 70 Hz	35 – 70 Hz	45–66 Hz
Current THD at 100% load	≤ 3%	≤ 4%	< 2%
Power factor at 100% load	≥ 0.99	≥ 0.99	0.99
<b>OUTPUT</b>			
Rated output voltage (load dependent)	220 / 380, 230 / 400, 240 / 415 VAC	220 / 380, 230 / 400, 240 / 415 VAC	3x 380/400/415 VAC
Voltage THD (with linear load)	< 2%	< 2%	< 1.5%
Rated frequency	50 or 60 Hz (selectable)	50 or 60 Hz (selectable)	50 or 60 Hz (selectable)
<b>EFFICIENCY</b>			
Line-interactive	–	–	–
Double conversion	Up to 95.5%	Up to 96%	up to 94.6%
Eco-mode	98%	99%	up to 98.7% (eBoost)
<b>COMMUNICATIONS</b>			
User Interface	LCD + mimic diagram	Graphical touch screen (optional on 160 – 200 kW), LCD+mimic diagram (on 60– 200 kW only)	System Graphical Display LCD
Communication ports	USB (optional), RS-232, SNMP slot, potential-free contacts (optional)	USB, RS-232, SNMP slot, potential-free contacts	RS232, SNMP (Modbus IP, RS232, RS485 & BacNet IP)
Software	Monitoring and shutdown software available as option		

# UPS product overview

## 10 kVA to 1.5 MVA

### 3 phase Modular UPS



GENERAL DATA	DPA UPScale RI	DPA UPScale ST	ConceptPower DPA S3	DPA 250 S4
<b>UPS frame rated power</b>	10/20/40/80 kW	40/60/80/120/200 kW	200 kW	300 kW
<b>UPS module rated power</b>	10/20 kW	10/20 kW	40 kW	50 kW
<b>UPS output rated PF</b>	1.0	1.0	-	1.0
<b>Max. no of parallel frames</b>	1 subrack	Up to 4 frames	Up to 6 frames	Up to 6 frames
<b>Max no of parallel modules across frames</b>	4 modules	20 modules	30 modules	36 modules
<b>Max system power</b>	80 kW	400 kW	1200 kW	1500 kW
<b>Wiring</b>	3ph + N + PE	3ph + N + PE	3ph + N + PE	3ph + N + PE
<b>UPS type</b>	<b>Modular (DPA)</b>	<b>Modular (DPA)</b>	<b>Modular (DPA)</b>	<b>Modular (DPA)</b>
<b>Topology</b>	Online double conversion	Online double conversion	Online double conversion	Online double conversion
<b>INPUT</b>				
<b>Nominal input voltage</b>	220/380, 230/400, 240/415 VAC	220/380, 230/400, 240/415 VAC	220/380, 230/400, 240/415 VAC	220/380, 230/400, 240/415 VAC
<b>Voltage range</b>	150/260 – 264/460 VAC	150/260 – 264/460 VAC	161/280 – 264/460 VAC	161/280 – 264/460 VAC
<b>Frequency range</b>	35 – 70 Hz	35 – 70 Hz	30 – 70 Hz	35 – 70 Hz
<b>Current THD at 100% load</b>	< 3%	< 3%	< 3%	< 3%
<b>Power factor at 100% load</b>	≥ 0.99	≥ 0.99	≥ 0.99	≥ 0.99
<b>OUTPUT</b>				
<b>Rated output voltage (load dependent)</b>	220/380, 230/400, 240/415 VAC	220/380, 230/400, 240/415 VAC	220/380, 230/400, 240/415 VAC	220/380, 230/400, 240/415 VAC
<b>Voltage THD (with linear load)</b>	< 1.5%	< 1.5%	< 2%	< 2%
<b>Rated frequency</b>	50 or 60 Hz (selectable)	50 or 60 Hz (selectable)	50 or 60 Hz (selectable)	50 or 60 Hz (selectable)
<b>EFFICIENCY</b>				
<b>Line-interactive</b>	-	-	-	-
<b>Double conversion</b>	Up to 96%	Up to 96%	Up to 95.5 %	Up to 97.6% module efficiency, up to 97.4% system efficiency
<b>Eco-mode</b>	98%	98%	98%	99%
<b>COMMUNICATIONS</b>				
<b>User Interface</b>	Module level LCD+mimic diagram, Remote system display optional	Module level LCD+mimic diagram, System graphical display	Module level LCD+mimic diagram, System graphical display	Module level LCD+mimic diagram, System graphical display
<b>Communication ports</b>	USB, RS-232, SNMP slot, potential-free contacts	USB, RS-232, SNMP slot, potential-free contacts	USB, RS-232, SNMP slot, potential-free contacts	USB, RS-232, SNMP slot, potential-free contacts
<b>Software</b>	Monitoring and shutdown software available as option			



# UPS product overview

## 1 kVA to 6 MVA

### 3 phase Modular UPS



GENERAL DATA	Conceptpower DPA 500	MegaFlex DPA
UPS frame rated power	500 kW	1000/1500 kW
UPS module rated power	100 kW	250 kW
UPS output rated PF	1.0	1.0
Max. no of parallel frames	Up to 6 frames	Up to 4 frames
Max no of parallel modules across frames	30 modules	24 modules
Max system power	3000 kW	6000 kW
Wiring	3ph + N + PE	3ph + N + PE
UPS type	<b>Modular (DPA)</b>	<b>Modular (DPA)</b>
Topology	Online double conversion	Online double conversion
<b>INPUT</b>		
Nominal input voltage	220/380, 230/400, 240/415 VAC	220/380, 230/400, 240/415 VAC
Voltage range	161/280 – 264/460 VAC	161/280 – 264/460 VAC
Frequency range	35 – 70 Hz	40 – 70 Hz
Current THD at 100% load	< 3.5%	<4%
Power factor at 100% load	≥ 0.99	≥ 0.99
<b>OUTPUT</b>		
Rated output voltage (load dependent)	220/380, 230/400, 240/415 VAC	220/380, 230/400, 240/415 VAC
Voltage THD (with linear load)	< 2%	< 2%
Rated frequency	50 or 60 Hz (selectable)	50 or 60 Hz (selectable)
<b>EFFICIENCY</b>		
Line-interactive	-	-
Double conversion	Up to 96%	Up to 97.4%
Eco-mode	99%	99%
<b>COMMUNICATIONS</b>		
User Interface	Module level LCD+mimic diagram,	Module level LCD+mimic diagram,
Communication ports	System graphical display USB, RS-232, SNMP slot, potential-free contacts	System graphical display USB, RS-232, potential-free contacts, ABB network card
Software	Monitoring and shutdown software available as option	

# Electrical installation solutions for buildings

## A world of advantages

### Miniature circuit-breakers

**1 S200 Series**  
Circuit breakers up to 63 A  
S200, S200M and S300P:  
For residential, commercial and  
industrial use up to 25 kA.  
SU200M and SU200MR  
with certification acc. to:  
Certification UL489/CSA 22.2  
No. 5 (US and Canada).

**2 SN201 Series**  
SN201 series circuit breakers  
including one pole and neutral  
in one module width up to  
40 A specific for household  
applications and tertiary sector.

**3 S800 Series**  
S800 circuit breakers with high  
breaking capacity up to 63 A  
S800B: 16 kA breaking capacity.  
S800C: 25 kA breaking capacity.  
S800N: 36 kA breaking capacity.  
S800S: 50 kA breaking capacity.

### Residual current protection

**4 F200 Series**  
Residual current devices up to 125 A  
F200: Residential, tertiary and industrial.

**5 DDA200 and DDA800 Series**  
RCD blocks adaptable to the S200  
and S800 circuit-breaker series up  
to 63 A and 100 A respectively.

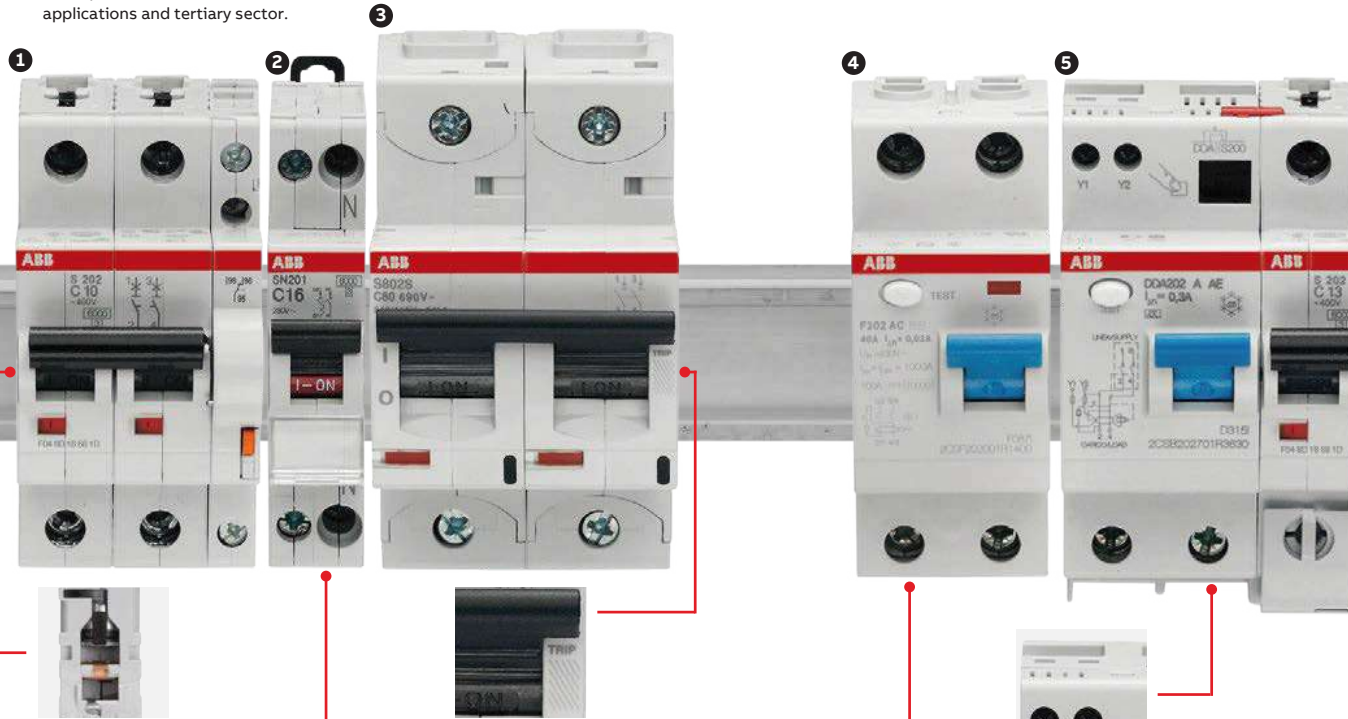

Increased terminal opening for higher wire gauges up to 35 mm<sup>2</sup>. For conductors with or without connector sleeves.  
Fulfills still the requirements for protection degree IP20 (finger safe) acc. to IEC/EN 60529. Integrated plate protecting flexible cables from damage and homogenous pressure in the terminal opening.



Multiple certification marks visible on the upper and lower face of the S200 circuit breakers. Laser marking for reliable readability. Real contact position indication, directly connected to the moving contact, for more comfort and safety. Individual identification code for each MCB on the front.



Switch with intermediate trip position (TRIP). S800 circuit breakers differentiate manual actuation from over-current trip.



Label-holder built into SN200 circuit breakers. Easy identification of protected circuits. One pole plus neutral in a width of just 17.6mm.



The green/red switch colour clearly indicates the connected/disconnected status.



Terminal on the front face for fail-safe function.



Failsafe bi-directional cylinder-lift terminal at top and bottom (available for the entire System pro M compact® range). Ideal for connection of cables and busbars simultaneously.

# Electrical installation solutions for buildings

## A world of advantages

### 6 DS200 Series

Overcurrent and residual current protection in a single device, just two modules width. Suitable for residential, tertiary and industrial applications.

### 7 RD3 residual current relays

Residual current relays with the possibility to set sensitivity and intervention time. Ideal to obtain time and sensitivity combinations and to achieve selectivity with other residual current devices.

### Other protection devices

### 8 OVR series surge protective devices

Protection of electrical equipment against surges caused by lightning or other grid disruptions.

### 9 E90 fuseholders and fuse disconnectors

E90: Disconnector series up to 32 A.  
E90h: Compact series up to 32 A.  
E90 50/125: Series up to 125 A.



Displays the cause of the trip of the DS200 residual current breaker. Blue (residual current) trip or black (over-current trip indications).



Includes RFID label. Prevents forgeries through the inclusion of a serial number in compliance with the ISO/IEC FCD 15693-3 standard.



Contact position indicator visible on the front of the DS200 residual current breaker.



Blown fuse indicator light on the front part of the E90 fuseholder.



Visual indicator of the remaining life of the OVR surge protective device. Option to include remote signaling contacts of the OVR status.

# Electrical installation solutions for buildings

## A world of advantages

### Command and control

**10** **Contactors, latching relays and installation relays**  
 ESB/EN..N series installation contactors.  
 E297 series installation relays.  
 E290 series latching relays.

**11** **Switch disconnectors**  
 E200 series  
 switch disconnectors  
 From 1 to 4 poles.  
 Up to 125 A.  
  
 SD200 switch disconnectors  
 From 1 to 4 poles.  
 Up to 63 A.  
 Fully compatible with  
 MCB accessories.

**12** **E210 series on-off switches, push buttons and indicator lamps**  
 E211 and E218 series on-off switches.  
 E213 series change over switches.  
 E214 series group switches.  
 E215 and E217 series push buttons.  
 E219 series single, double and triple indicator lights.

**13** **DBT digital and AG analogue time switches**  
 DW1 and DW2 weekly digital time switches.  
 DY365 yearly digital time switches.  
 AG analogue time switches.

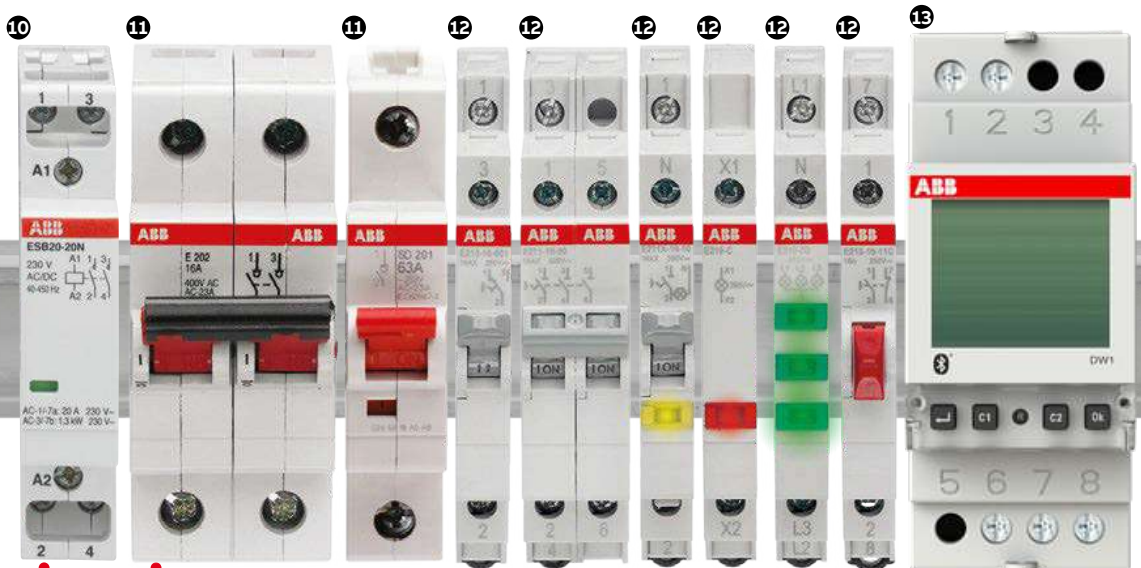

Currents up to 125 A.  
 From 1 to 4 poles.  
 Option to include an add-on of  
 up to 3 auxiliary contacts.

Hum-free operation.  
 Variety of control voltages.  
 Multiple combinations of NO and NC contacts.  
 Function modes selector:  
 Automatic/Connected/Disconnected (EN series).

Multiple command and control  
 functions in the ultra-compact  
 design (9 mm width) of the  
 E210 series.

Up to 3 E219 LED  
 indicator lights in  
 a width of just 9 mm.  
 LED indicators  
 guarantee an optimal  
 illumination with very  
 low consumption.

# Electrical installation solutions for buildings

## A world of advantages

**14 DWA astronomical switches and DW twilight switches**

DWA astronomical switches to activate lighting systems according to the rising and setting of the sun.  
DW twilight switches to control lighting devices according to the level of the ambient light.

**15 E234 series electronic timers and E232 series staircase switches**

Wide range of E234.  
E232 staircase timers for household applications.

**16 CP-D primary switch mode power supplies**

Optimized for world-wide applications with a wide AC and DC supply range and continuously adjustable output voltage. Additional redundancy unit CP-RUD available.

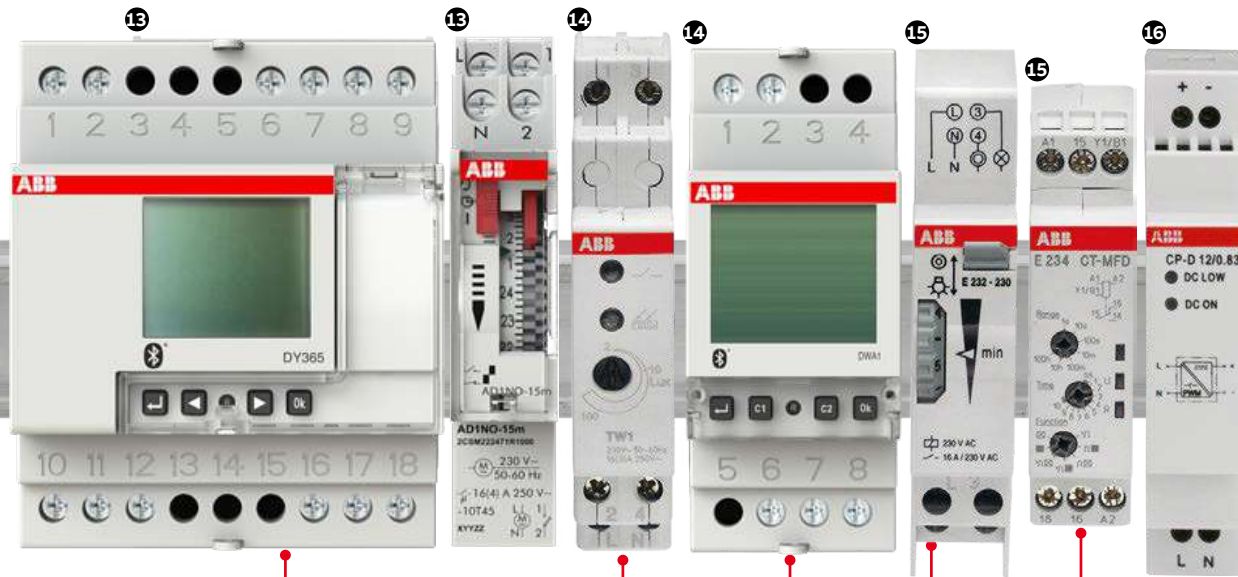

D-Line series weekly and annual digital time switches. Multiple communication options. Wide range of programs: standard, cyclic, casual and holiday. White backlit LCD display.

Connection and disconnection time delays. Continuous and impulse signals among multiple options.

Easy to program. Ideal for public lighting, stores lighting, monuments, etc.

# Miniature Circuit Breaker SB200 M

The details make the difference

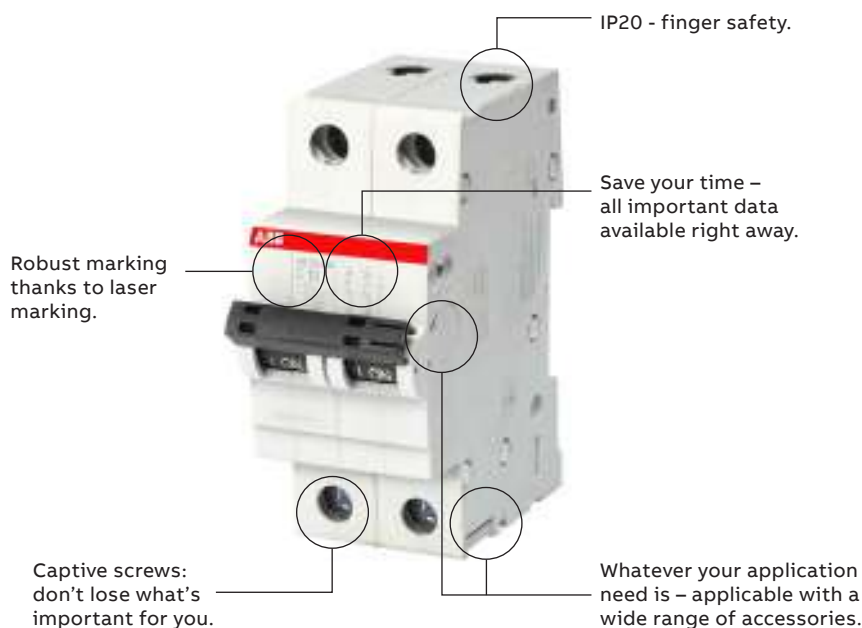

## Technical Features

### General data

Standards	IEC/IS 60898-1, IEC/IS 60947-2
Poles	B: 1P, 1P+N, 2P C: 1P, 2P, 3P, 4P, 1P+N, 3P+N D: 1P, 2P, 3P, 4P
Rated short-circuit capacity (Icn)	10 kA
Rated ultimate short-circuit breaking capacity Icu (acc.to IEC 60947-2)	15 kA
Tripping characteristics	B, C, D
Reference temperature for tripping characteristics	30°C
Energy limiting class (B-,C- Curve)	3
Rated voltage Ue	1P : 240/415 V AC 1P + N : 240 V AC 2...4P : 415 V AC 3P + N : 415 V AC
Rated current In	B: 6, 10, 16, 20, 25, 32, 40 A C&D: 0,5, 1, 1,6, 2, 3, 4, 6, 10, 16, 20, 25, 32, 40, 50, 63 A
Rated frequency	50 Hz
Max. Power frequency recovery voltage (Umax)	1P: 264 V AC; 60V DC; 1P+N:264 V AC; 2...4P : 457 V AC; 2P: 120V DC; 3P+N: 457 V AC
Min. operating voltage	12 V AC
Rated insulation voltage Ui acc. to IEC/EN 60664-1	250 V AC (phase to ground) , 440 V AC (phase to phase)
Rated impulse withstand voltage Uimp. (1.2/50µs)	4 kV (test voltage 6.2kV at sea level, 5kV at 2.000m)
Dielectric test voltage	2 kV (50 / 60Hz, 1 min.)
Overvoltage category	III
Pollution degree	3
Electrical endurance	In < 32A: 20.000 ops.(AC), In ≥ 32A: 10.000 ops.(AC); 1.000 ops. (DC); 1 cycle (2s - ON, 13s - OFF, In ≤ 32A), 1 cycle (2s - ON, 28s - OFF, In >32A)

# MCB SB200 M

## B characteristic



SB201 M B 16

### SB200 M B characteristic

Function: protection and control of the circuits against overloads and short-circuits; protection for resistive and inductive loads with low inrush current.

Applications: residential, commercial and industrial.

Standard: IEC/IS 60898-1, IEC/IS 60947-2

Icn=10 kA

### SB201 M B

Number of poles	Rated current In A	Order details		Standard pack	Unit MRP ₹
		Type code	Order code		
1P	6	SB201 M-B6	1SYS271012R0065 ■	12	370
	10	SB201 M-B10	1SYS271012R0105 ■	12	370
	16	SB201 M-B16	1SYS271012R0165 ■	12	370
	20	SB201 M-B20	1SYS271012R0205 ■	12	370
	25	SB201 M-B25	1SYS271012R0255 ■	12	370
	32	SB201 M-B32	1SYS271012R0325 ■	12	370
	40	SB201 M-B40	1SYS271012R0405 ■	12	740

### SB201 M B NA

Number of poles	Rated current In A	Order details		Standard pack	Unit MRP ₹
		Type code	Order code		
1P+N	6	SB201 M-B6 NA	1SYS271112R0065 ■	6	1,090
	10	SB201 M-B10 NA	1SYS271112R0105 ■	6	1,090
	16	SB201 M-B16 NA	1SYS271112R0165 ■	6	1,090
	20	SB201 M-B20 NA	1SYS271112R0205 ■	6	1,090
	25	SB201 M-B25 NA	1SYS271112R0255 ■	6	1,090
	32	SB201 M-B32 NA	1SYS271112R0325 ■	6	1,090
	40	SB201 M-B40 NA	1SYS271112R0405 ■	6	1,770

### SB202 M B

Number of poles	Rated current In A	Order details		Standard pack	Unit MRP ₹
		Type code	Order code		
2P	6	SB202 M-B6	1SYS272012R0065 ■	6	1,080
	10	SB202 M-B10	1SYS272012R0105 ■	6	1,080
	16	SB202 M-B16	1SYS272012R0165 ■	6	1,080
	20	SB202 M-B20	1SYS272012R0205 ■	6	1,080
	25	SB202 M-B25	1SYS272012R0255 ■	6	1,080
	32	SB202 M-B32	1SYS272012R0325 ■	6	1,080
	40	SB202 M-B40	1SYS272012R0405 ■	6	1,720

# MCB SB200 M

## C characteristic



SB201 M C 16

### SB200 M C characteristic

Function: protection and control of the circuits against overloads and short-circuits; protection for resistive and inductive loads with low inrush current.

**Applications: residential, commercial and industrial.**

**Standard: IEC/IS 60898-1, IEC/IS 60947-2**

**Icn=10 kA**

### SB201 M C

Number of poles	Rated current In A	Order details		Standard pack	Unit MRP ₹
		Type code	Order code		
1P	0.5	SB201 M-C0.5	1SYS271012R0984	12	620
	1	SB201 M-C1	1SYS271012R0014	12	620
	1.6	SB201 M-C1.6	1SYS271012R0974	12	620
	2	SB201 M-C2	1SYS271012R0024	12	540
	3	SB201 M-C3	1SYS271012R0034	12	540
	4	SB201 M-C4	1SYS271012R0044	12	540
	6	SB201 M-C6	1SYS271012R0064 ■	12	370
	10	SB201 M-C10	1SYS271012R0104 ■	12	370
	16	SB201 M-C16	1SYS271012R0164 ■	12	370
	20	SB201 M-C20	1SYS271012R0204 ■	12	370
	25	SB201 M-C25	1SYS271012R0254 ■	12	370
	32	SB201 M-C32	1SYS271012R0324 ■	12	370
	40	SB201 M-C40	1SYS271012R0404	12	740
	50	SB201 M-C50	1SYS271012R0504	12	740
	63	SB201 M-C63	1SYS271012R0634	12	740

### SB201 M C NA

Number of poles	Rated current In A	Order details		Standard pack	Unit MRP ₹
		Type code	Order code		
1P+N	0.5	SB201 M-C0.5 NA	1SYS271112R0984	6	1,800
	1	SB201 M-C1 NA	1SYS271112R0014	6	1,800
	1.6	SB201 M-C1.6 NA	1SYS271112R0974	6	1,800
	2	SB201 M-C2 NA	1SYS271112R0024	6	1,570
	3	SB201 M-C3 NA	1SYS271112R0034	6	1,570
	4	SB201 M-C4 NA	1SYS271112R0044	6	1,570
	6	SB201 M-C6 NA	1SYS271112R0064 ■	6	1,090
	10	SB201 M-C10 NA	1SYS271112R0104 ■	6	1,090
	16	SB201 M-C16 NA	1SYS271112R0164 ■	6	1,090
	20	SB201 M-C20 NA	1SYS271112R0204 ■	6	1,090
	25	SB201 M-C25 NA	1SYS271112R0254 ■	6	1,090
	32	SB201 M-C32 NA	1SYS271112R0324 ■	6	1,090
	40	SB201 M-C40 NA	1SYS271112R0404 ■	6	1,770
	50	SB201 M-C50 NA	1SYS271112R0504 ■	6	1,770
	63	SB201 M-C63 NA	1SYS271112R0634 ■	6	1,770

■ Stock items



# MCB SB200 M

## C characteristic



SB202 M C 16

### SB202 M C

Number of poles	Rated current In A	Order details		Standard pack	Unit MRP ₹
		Type code	Order code		
2P	0.5	SB202 M-C0.5	1SYS272012R0984	6	1,670
	1	SB202 M-C1	1SYS272012R0014	6	1,670
	1.6	SB202 M-C1.6	1SYS272012R0974	6	1,670
	2	SB202 M-C2	1SYS272012R0024	6	1,520
	3	SB202 M-C3	1SYS272012R0034	6	1,520
	4	SB202 M-C4	1SYS272012R0044	6	1,520
	6	SB202 M-C6	1SYS272012R0064 ■	6	1,080
	10	SB202 M-C10	1SYS272012R0104 ■	6	1,080
	16	SB202 M-C16	1SYS272012R0164 ■	6	1,080
	20	SB202 M-C20	1SYS272012R0204 ■	6	1,080
	25	SB202 M-C25	1SYS272012R0254 ■	6	1,080
	32	SB202 M-C32	1SYS272012R0324 ■	6	1,080
	40	SB202 M-C40	1SYS272012R0404 ■	6	1,720
	50	SB202 M-C50	1SYS272012R0504 ■	6	1,720
	63	SB202 M-C63	1SYS272012R0634 ■	6	1,720

### SB203 M C

Number of poles	Rated current In A	Order details		Standard pack	Unit MRP ₹
		Type code	Order code		
3P	0.5	SB203 M-C0.5	1SYS273012R0984	4	2,580
	1	SB203 M-C1	1SYS273012R0014	4	2,580
	1.6	SB203 M-C1.6	1SYS273012R0974	4	2,580
	2	SB203 M-C2	1SYS273012R0024	4	2,350
	3	SB203 M-C3	1SYS273012R0034	4	2,350
	4	SB203 M-C4	1SYS273012R0044	4	2,350
	6	SB203 M-C6	1SYS273012R0064 ■	4	1,770
	10	SB203 M-C10	1SYS273012R0104 ■	4	1,770
	16	SB203 M-C16	1SYS273012R0164 ■	4	1,770
	20	SB203 M-C20	1SYS273012R0204 ■	4	1,770
	25	SB203 M-C25	1SYS273012R0254 ■	4	1,770
	32	SB203 M-C32	1SYS273012R0324 ■	4	1,770
	40	SB203 M-C40	1SYS273012R0404 ■	4	2,700
	50	SB203 M-C50	1SYS273012R0504 ■	4	2,700
	63	SB203 M-C63	1SYS273012R0634 ■	4	2,700

■ Stock items

# MCB SB200 M

## C characteristic

### SB203M C NA

Number of poles	Rated current In A	Order details		Standard pack	Unit MRP ₹
		Type code	Order code		
3P+N	0.5	SB203 M-C0.5 NA	1SYS273112R0984	3	3,810
	1	SB203 M-C1 NA	1SYS273112R0014	3	3,810
	1.6	SB203 M-C1.6 NA	1SYS273112R0974	3	3,810
	2	SB203 M-C2 NA	1SYS273112R0024	3	3,340
	3	SB203 M-C3 NA	1SYS273112R0034	3	3,340
	4	SB203 M-C4 NA	1SYS273112R0044	3	3,340
	6	SB203 M-C6 NA	1SYS273112R0064 ■	3	2,410
	10	SB203 M-C10 NA	1SYS273112R0104 ■	3	2,410
	16	SB203 M-C16 NA	1SYS273112R0164 ■	3	2,410
	20	SB203 M-C20 NA	1SYS273112R0204 ■	3	2,410
	25	SB203 M-C25 NA	1SYS273112R0254 ■	3	2,410
	32	SB203 M-C32 NA	1SYS273112R0324 ■	3	2,410
	40	SB203 M-C40 NA	1SYS273112R0404 ■	3	3,400
	50	SB203 M-C50 NA	1SYS273112R0504 ■	3	3,400
63	SB203 M-C63 NA	1SYS273112R0634 ■	3	3,400	



SB204 M C 16

### SB204 M C

Number of poles	Rated current In A	Order details		Standard pack	Unit MRP ₹
		Type code	Order code		
4P	0.5	SB204 M-C0.5	1SYS274012R0984	3	3,610
	1	SB204 M-C1	1SYS274012R0014	3	3,610
	1.6	SB204 M-C1.6	1SYS274012R0974	3	3,610
	2	SB204 M-C2	1SYS274012R0024	3	3,160
	3	SB204 M-C3	1SYS274012R0034	3	3,160
	4	SB204 M-C4	1SYS274012R0044	3	3,160
	6	SB204 M-C6	1SYS274012R0064 ■	3	2,280
	10	SB204 M-C10	1SYS274012R0104 ■	3	2,280
	16	SB204 M-C16	1SYS274012R0164 ■	3	2,280
	20	SB204 M-C20	1SYS274012R0204 ■	3	2,280
	25	SB204 M-C25	1SYS274012R0254 ■	3	2,280
	32	SB204 M-C32	1SYS274012R0324 ■	3	2,280
	40	SB204 M-C40	1SYS274012R0404 ■	3	3,490
	50	SB204 M-C50	1SYS274012R0504 ■	3	3,490
63	SB204 M-C63	1SYS274012R0634 ■	3	3,490	

■ Stock items

# MCB SB200 M

## D characteristic

### SB200 M D characteristic

Function: protection and control of the circuits against overloads and short-circuits; protection for resistive and inductive loads with low inrush current.

**Applications: residential, commercial and industrial.**

**Standard: IEC/IS 60898-1, IEC/IS 60947-2**

**Icn=10 kA**



SB202 M D 16

### SB201 M D

Number of poles	Rated current In A	Order details		Standard pack	Unit MRP ₹
		Type code	Order code		
1P	0.5	SB201 M-D0,5	1SYS271012R0981	12	720
	1	SB201 M-D1	1SYS271012R0011	12	720
	1.6	SB201 M-D1,6	1SYS271012R0971	12	720
	2	SB201 M-D2	1SYS271012R0021	12	630
	3	SB201 M-D3	1SYS271012R0031	12	630
	4	SB201 M-D4	1SYS271012R0041	12	630
	6	SB201 M-D6	1SYS271012R0061	12	510
	10	SB201 M-D10	1SYS271012R0101	12	510
	16	SB201 M-D16	1SYS271012R0161	12	510
	20	SB201 M-D20	1SYS271012R0201	12	510
	25	SB201 M-D25	1SYS271012R0251	12	510
	32	SB201 M-D32	1SYS271012R0321	12	510
	40	SB201 M-D40	1SYS271012R0401	12	860
	50	SB201 M-D50	1SYS271012R0501	12	860
	63	SB201 M-D63	1SYS271012R0631	12	860

### SB202 M D

Number of poles	Rated current In A	Order details		Standard pack	Unit MRP ₹
		Type code	Order code		
2P	0.5	SB202 M-D0.5	1SYS272012R0981	6	1,980
	1	SB202 M-D1	1SYS272012R0011	6	1,980
	1.6	SB202 M-D1.6	1SYS272012R0971	6	1,980
	2	SB202 M-D2	1SYS272012R0021	6	1,730
	3	SB202 M-D3	1SYS272012R0031	6	1,730
	4	SB202 M-D4	1SYS272012R0041	6	1,730
	6	SB202 M-D6	1SYS272012R0061	6	1,240
	10	SB202 M-D10	1SYS272012R0101	6	1,240
	16	SB202 M-D16	1SYS272012R0161	6	1,240
	20	SB202 M-D20	1SYS272012R0201	6	1,240
	25	SB202 M-D25	1SYS272012R0251	6	1,240
	32	SB202 M-D32	1SYS272012R0321	6	1,240
	40	SB202 M-D40	1SYS272012R0401	6	2,040
	50	SB202 M-D50	1SYS272012R0501	6	2,040
	63	SB202 M-D63	1SYS272012R0631	6	2,040

# MCB SB200 M

## D characteristic



SB203 M D 16

### SB203 M D

Number of poles	Rated current In A	Order details		Standard pack	Unit MRP ₹
		Type code	Order code		
3P	0.5	SB203 M-D0.5	1SYS273012R0981	4	3,060
	1	SB203 M-D1	1SYS273012R0011	4	3,060
	1.6	SB203 M-D1.6	1SYS273012R0971	4	3,060
	2	SB203 M-D2	1SYS273012R0021	4	2,680
	3	SB203 M-D3	1SYS273012R0031	4	2,680
	4	SB203 M-D4	1SYS273012R0041	4	2,680
	6	SB203 M-D6	1SYS273012R0061	4	2,020
	10	SB203 M-D10	1SYS273012R0101	4	2,020
	16	SB203 M-D16	1SYS273012R0161	4	2,020
	20	SB203 M-D20	1SYS273012R0201	4	2,020
	25	SB203 M-D25	1SYS273012R0251	4	2,020
	32	SB203 M-D32	1SYS273012R0321	4	2,020
	40	SB203 M-D40	1SYS273012R0401	4	3,190
	50	SB203 M-D50	1SYS273012R0501	4	3,190
63	SB203 M-D63	1SYS273012R0631	4	3,190	

### SB204 M D

Number of poles	Rated current In A	Order details		Standard pack	Unit MRP ₹
		Type code	Order code		
4P	0.5	SB204 M-D0.5	1SYS274012R0981	3	3,350
	1	SB204 M-D1	1SYS274012R0011	3	3,350
	1.6	SB204 M-D1.6	1SYS274012R0971	3	3,350
	2	SB204 M-D2	1SYS274012R0021	3	3,520
	3	SB204 M-D3	1SYS274012R0031	3	3,520
	4	SB204 M-D4	1SYS274012R0041	3	3,520
	6	SB204 M-D6	1SYS274012R0061	3	2,800
	10	SB204 M-D10	1SYS274012R0101	3	2,800
	16	SB204 M-D16	1SYS274012R0161	3	2,800
	20	SB204 M-D20	1SYS274012R0201	3	2,800
	25	SB204 M-D25	1SYS274012R0251	3	2,800
	32	SB204 M-D32	1SYS274012R0321	3	2,800
	40	SB204 M-D40	1SYS274012R0401	3	3,690
	50	SB204 M-D50	1SYS274012R0501	3	3,690
63	SB204 M-D63	1SYS274012R0631	3	3,690	

# Miniature Circuit Breaker SB200 DC

Right product for right application

The range impresses with its performance, approvals and high in-built short-circuit breaking capacity for

DC application. Can be used in SP version at 250V DC and DP version upto 500V DC.

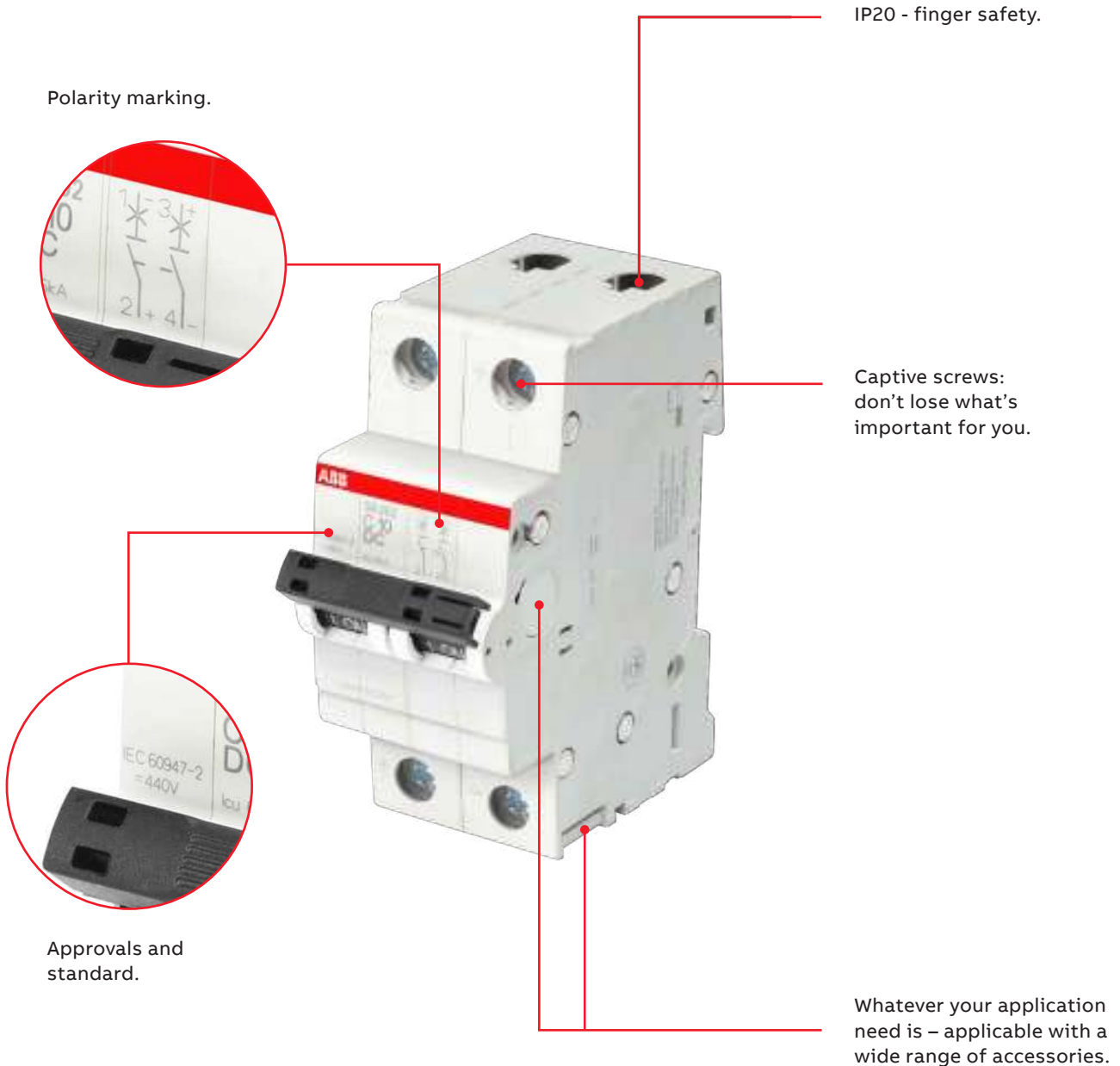

Polarity marking.

IP20 - finger safety.

Captive screws:  
don't lose what's  
important for you.

Approvals and  
standard.

Whatever your application  
need is - applicable with a  
wide range of accessories.



**State-of-the-art design  
(Aesthetics & Ergonomics)**

Elegant in appearance and the knob is designed for easy operation.



**Laser marking**

All printing of the SB200 MCBs, like the approvals on the product identification, are printed by a laser. The laser printing ensures a friction, scratch and solvent resistant marking on the MCBs. Easy identification of the products in case of maintenance or replacement, due to safe laser printing.



**Housing cover with fire retardant material**

High performance 100% recyclable plastic material with fire retardant, high melting point, low water absorption & high dielectric strength properties. ABB is taking care of the environment... with the latest generation of thermoplastics, it is possible to recycle the MCBs – especially the thermoplastic housing material can be re-used. SB200 is 100% free of halogens.



**IP20 protection**

IP20 - finger safe terminals. The System pro M compact® MCBs are equipped with 25 mm<sup>2</sup> cylinder lift twin terminals, a well-proven and reliable technology - designed for sophisticated industrial use. The cross wiring can easily be done by inserting the System pro M compact® busbars into the rear terminal part and then the incoming wires into the front part of the terminal.



**Labelling area**

Provision for providing label enables easy identification and polarity marking of circuit during installation, operation & maintenance.



**Accessories mountable**

Wide range of add-on accessories having 30 different types of accessories. Max. possibility of mounting: 4 different accessories on the right side and 1 on the left side ensures highest flexibility of functions. Universal contact, motorised unique accessory like mechanical tripping devices available only with ABB.

# MCB SB200 DC

## C characteristic

### SB200 DC characteristic

Function: protection and control of the circuits against overloads and short-circuits; protection for resistive and inductive loads with low inrush current.

**Applications: residential, commercial and industrial.**

**Standard: IS/IEC 60947-2**

**I<sub>cn</sub>=6 kA**



SB201 C 6 DC

### SB201 DC C

Number of poles	Rated current In A	Order details		Standard pack	L.P.(₹)
		Type code	Order code		
1P	1.6	SB201-C1.6DC	1SYS251067R0974	12	1,130
	2	SB201-C2DC	1SYS251067R0024	12	1,130
	3	SB201-C3DC	1SYS251067R0034	12	1,130
	4	SB201-C4DC	1SYS251067R0044	12	1,130
	6	SB201-C6DC	1SYS251067R0064	12	920
	10	SB201-C10DC	1SYS251067R0104	12	920
	16	SB201-C16DC	1SYS251067R0164	12	920
	20	SB201-C20DC	1SYS251067R0204	12	920
	25	SB201-C25DC	1SYS251067R0254	12	920
	32	SB201-C32DC	1SYS251067R0324	12	920
	40	SB201-C40DC	1SYS251067R0404	12	1,180
	50	SB201-C50DC	1SYS251067R0504	12	1,180
	63	SB201-C63DC	1SYS251067R0634	12	1,180

### SB202 DC



SB202 C 10 DC

Number of poles	Rated current In A	Order details		Standard pack	L.P.(₹)
		Type code	Order code		
2P	1.6	SB202-C1.6DC	1SYS252067R0974	6	2,400
	2	SB202-C2DC	1SYS252067R0024	6	2,400
	3	SB202-C3DC	1SYS252067R0034	6	2,400
	4	SB202-C4DC	1SYS252067R0044	6	2,400
	6	SB202-C6DC	1SYS252067R0064	6	1,940
	10	SB202-C10DC	1SYS252067R0104	6	1,940
	16	SB202-C16DC	1SYS252067R0164	6	1,940
	20	SB202-C20DC	1SYS252067R0204	6	1,940
	25	SB202-C25DC	1SYS252067R0254	6	1,940
	32	SB202-C32DC	1SYS252067R0324	6	1,940
	40	SB202-C40DC	1SYS252067R0404	6	2,620
	50	SB202-C50DC	1SYS252067R0504	6	2,620
	63	SB202-C63DC	1SYS252067R0634	6	2,620

# Miniature Circuit Breaker (MCB)

## S200 series - 80, 100A



S201C

### Features

- Breaking capacity - 6kA
- Tripping characteristics - C curve
- Suitable for -25..... +55 °C ambient temperatures
- Standards : Conforms to IEC60898, IEC60947-2

Description	Current rating (A)	Pack unit (Pc)	Ordering code	L.P.(₹)
<b>Single pole</b>				
S201-C80	80	1	2CDS251001R0804	3,540
S201-C100	100	1	2CDS251001R0824	4,140
<b>Single pole &amp; neutral</b>				
S201-C80NA	80	1	2CDS251103R0804	7,410
S201-C100NA	100	1	2CDS251103R0824	8,840
<b>Double pole</b>				
S202-C80	80	1	2CDS252001R0804	6,940
S202-C100	100	1	2CDS252001R0824	8,020
<b>Triple pole</b>				
S203-C80	80	1	2CDS253001R0804	10,110
S203-C100	100	1	2CDS253001R0824	12,220
<b>Triple pole &amp; neutral</b>				
S203-C80NA	80	1	2CDS253103R0804	15,190
S203-C100NA	100	1	2CDS253103R0824	18,120
<b>Four pole</b>				
S204-C80	80	1	2CDS254001R0804	14,190
S204-C100	100	1	2CDS254001R0824	15,350



# Miniature Circuit Breaker SH800 (80-125A) **NEW**

## Features

- Up to 125 A (80 A, 100 A, 125 A)
- Clear contact position indication in red/green
- High performance up to 10 kA at  $U_e=415V$  AC acc. To IEC/EN 60947-2
- Can be used in harsh industry environment (-25 to +60 °C)

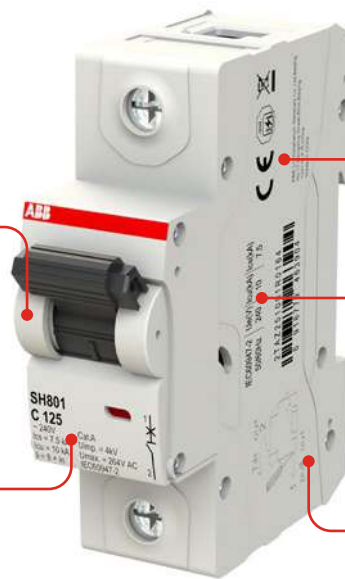

Modern design and easier to operate

World-wide usability with global certifications

Technical parameters available

Key features:

- High breaking capacity  $I_{cu}=10$  kA conform to IEC 60947-2
- Higher rated voltage (240 V/415 V), More adaptable applications and regions

Illustration for easy disassembly

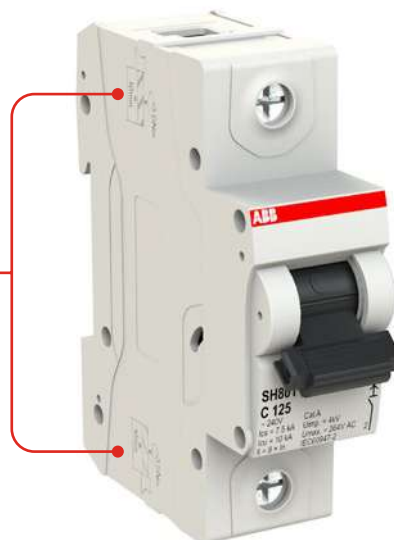

Quick guide for the length of cable wiring

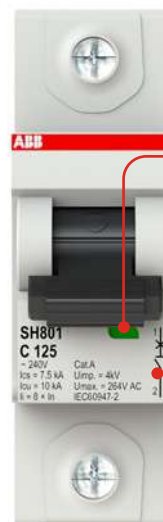

Contact indication window: customer could easily find the on/off status of the MCB

Electrical diagrams

# Miniature Circuit Breaker SH800 (80-125A) NEW



## SH800 - 'C' Curve 10 kA as per IEC 60947-2 Single pole

Description	Current rating (A)	Pack unit (Pc)	Ordering code	L.P.(₹)
SH801-C80	80	1	2TAZ190100R0804	5,230
SH801-C100	100	1	2TAZ190100R0824	5,570
SH801-C125	125	1	2TAZ190100R0844	5,820

## Double pole

Description	Current rating (A)	Pack unit (Pc)	Ordering code	L.P.(₹)
SH802-C80	80	1	2TAZ190200R0804	11,180
SH802-C100	100	1	2TAZ190200R0824	11,950
SH802-C125	125	1	2TAZ190200R0844	13,650



## Triple pole

Description	Current rating (A)	Pack unit (Pc)	Ordering code	L.P.(₹)
SH803-C80	80	1	2TAZ190300R0804	17,650
SH803-C100	100	1	2TAZ190300R0824	18,800
SH803-C125	125	1	2TAZ190300R0844	20,660

## Four pole

Description	Current rating (A)	Pack unit (Pc)	Ordering code	L.P.(₹)
SH804-C80	80	1	2TAZ190400R0804	22,980
SH804-C100	100	1	2TAZ190400R0824	23,910
SH804-C125	125	1	2TAZ190400R0844	26,840



## SH800 - 'D' Curve 10 kA as per IEC 60947-2 Single pole

Description	Current rating (A)	Pack unit (Pc)	Ordering code	L.P.(₹)
SH801-D80	80	1	2TAZ190100R0801	5,550
SH801-D100	100	1	2TAZ190100R0821	6,130
SH801-D125	125	1	2TAZ190100R0841	6,540

## Double pole

Description	Current rating (A)	Pack unit (Pc)	Ordering code	L.P.(₹)
SH802-D80	80	1	2TAZ190200R0801	12,300
SH802-D100	100	1	2TAZ190200R0821	13,140
SH802-D125	125	1	2TAZ190200R0841	14,290

## Triple pole

Description	Current rating (A)	Pack unit (Pc)	Ordering code	L.P.(₹)
SH803-D80	80	1	2TAZ190300R0801	19,420
SH803-D100	100	1	2TAZ190300R0821	20,680
SH803-D125	125	1	2TAZ190300R0841	22,730

## Four pole

Description	Current rating (A)	Pack unit (Pc)	Ordering code	L.P.(₹)
SH804-D80	80	1	2TAZ190400R0801	25,290
SH804-D100	100	1	2TAZ190400R0821	26,330
SH804-D125	125	1	2TAZ190400R0841	29,520



# Switch Disconnecter SDB200

The details make the difference

**Easy product coding – easy identification:**  
basic technical information already integrated into the name.

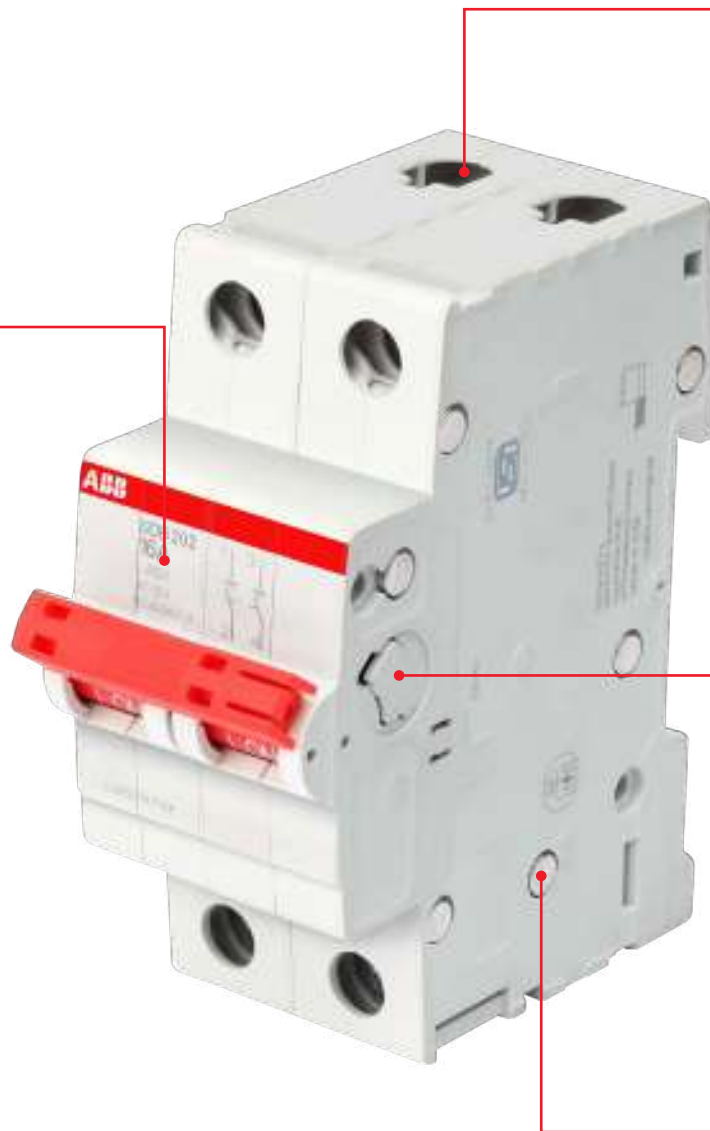

IP20 - finger safety.

Fully compatible with all System pro M devices and accessories.

**Patented housing design:**  
Environment-friendly and performance-optimized.



#### Patented housing design

By using state-of-the-art housing material, ABB is taking care of the environment. With the latest generation of halogen-free thermoplastics for SDB200, it is possible to recycle the switch disconnectors completely without environmental pollution. The material works for the stability.



#### Highest performance

With a rated voltage of 253/440 V AC, a rated conditional short-circuit current of 25 kA, terminals with protection from misconnection, a "Real CPI" switching position display, as well as full compatibility with all MCB accessories, the SDB200 is unique in its field of application. SDB200 complies with IEC/EN 60947-3.



#### IP20 protection

IP20 - finger safe terminals. The System pro M compact® MCBs are equipped with 25 mm<sup>2</sup> cylinder lift twin terminals, a well-proven and reliable technology - designed for sophisticated industrial use. The cross wiring can be easily done by inserting the System pro M compact® busbars into the rear terminal part and then the incoming wires into the front part of the terminal.



#### Laser printing

All labels on the SDB200, as the approvals on the dome, technical details and the product identification, are printed by a laser. The laser printing ensures a friction, scratch and solvent resistant marking on the switch disconnectors for easy identification in case of maintenance or replacement. For control and acceptance procedure, it is important to see all markings also in the mounted position.



#### ISI and CE marking

In addition to the International standards and markings IEC, the product is certified as per latest Indian Standards (ISI)



#### Wide range of accessories

SDB200 is fully compatible to the complete range of System pro M compact accessories like:

- Auxiliary contacts, to be mounted on the left side, the right side or bottom fitting
- Shunt trips
- Undervoltage release
- Motor operating devices

# Switch Disconnecter

## SDB200



SDB203 16 A

### SDB202

Number of poles	Rated current In A	Order details		Standard pack	Unit MRP ₹
		Type code	Order code		
2P	40	SDB202/40	1SYD272115R0040 ■	6	850
	63	SDB202/63	1SYD272115R0063 ■	6	1,110

### SDB203

Number of poles	Rated current In A	Order details		Standard pack	Unit MRP ₹
		Type code	Order code		
3P	40	SDB203/40	1SYD273115R0040 ■	4	1,450
	63	SDB203/63	1SYD273115R0063 ■	4	1,700

### SDB204

Number of poles	Rated current In A	Order details		Standard pack	Unit MRP ₹
		Type code	Order code		
4P	40	SDB204/40	1SYD274115R0040 ■	3	1,810
	63	SDB204/63	1SYD274115R0063 ■	3	1,990

Note: Standard packing quantity for SDB switch Disconnecter: DP-6 Nos, TP-4 Nos, FP-3 Nos.

## E200



E201

### E200

Number of poles	Rated current In A	Order details		Standard pack	Unit L.P. ₹
		Type code	Order code		

#### Double pole

2P	80	E202/80r	2CDE282001R0080	1	1,390
	100	E202/100r	2CDE282001R0100	1	2,180
	125	E202/125r	2CDE282001R0125	1	2,260

#### Triple pole

3P	80	E203/80r	2CDE283001R0080	1	2,330
	100	E203/100r	2CDE283001R0100	1	2,550
	125	E203/125r	2CDE283001R0125	1	2,850

#### Four pole

4P	80	E204/80r	2CDE284001R0080	1	2,620
	100	E204/100r	2CDE284001R0100	1	2,780
	125	E204/125r	2CDE284001R0125	1	3,110

## Change over switch



E213

Description	Ordering code	L.P. (₹)
E213-16-002, double pole change over switch, 16 A (I-II)	2CCA703045R0001	3,170
E213-25-002, double pole change over switch, 25 A (I-II)	2CCA703046R0001	3,940
E214-16-202, group switch, 16 A (I-O-II)	2CCA703030R0001	3,560
E214-25-202, group switch, 25 A (I-O-II)	2CCA703031R0001	3,990

■ Stock items

# Residual Current Circuit Breaker FB200

A range designed to ensure efficiency and protection



Bi-directional cylindrical terminal ensures higher safety of connecting operations, making them easier.

Test push-button to verify the correct functioning of the device.

Information on the device is laser printed to make it clearly visible and long lasting.

Laser-marked order code on the front to make easier future orders.



### ISI and CE marking

In addition to the international standards and markings IEC, the product is certified as per latest Indian Standards (ISI).



### High performance

- Rated breaking capacity and rated residual breaking capacity laser printed on the device:  
 $I_m = I_{\Delta m} = 1000 \text{ mA}$
- Co-ordination with a 63 A rated current with conditional short-circuit capacity  $I_{nc} = 10000 \text{ A}$ .



### Accessories mountable

Wide range of add-on accessories having 30 different types of accessories. Max. possibility of mounting: 4 different accessories on the right side and 1 on the left side ensures highest flexibility of functions. Universal contact, motorised unique accessory like mechanical tripping devices available only with ABB.



### Termination

The availability of two terminals offers different connection solutions, thanks to the possibility to connect two independent cables in the same device: the second terminal can be used for an auxiliary circuit or for the supply of devices with small section cables without connecting them together with the main circuit.



### Auto reclosing

The FB200 can be coupled with the auto reclosing unit F2C-ARH in order to ensure continuity of service for the whole installation of your home, avoiding lack of supply.



### Dual termination

Two terminals are available, the fore one for cables up to  $25 \text{ mm}^2$ , the back one for cables up to  $10 \text{ mm}^2$  or for busbars.

# RCCB FB200 and F200 higher rating

AC  type

**FB200 AC and F200 type function:** protection against the effects of sinusoidal alternating earth fault currents; protection against indirect contacts and additional protection against direct contacts (with  $I_{\Delta n}=30$  mA).

**Application:** residential, commercial, industrial.

**Standard:** IEC/EN 61008-1; IEC/EN 61008-2-1

**Marking:** according to EN 61008-1; EN 61008-2-1



FB202 AC

## FB202 AC

Number of poles	Rated current In A	Residual rated current (mA)	Order details		Standard pack	Unit MRP ₹
			Type code	Order code		
2P	25	30	FB202 AC-25/0.03	1SYF202015R1250 ■	1	3,960
	25	100	FB202 AC-25/0.1	1SYF202015R2250 ■	1	4,160
	25	300	FB202 AC-25/0.3	1SYF202015R3250	1	4,180
	40	30	FB202 AC-40/0.03	1SYF202015R1400 ■	1	4,550
	40	100	FB202 AC-40/0.1	1SYF202015R2400 ■	1	4,760
	40	300	FB202 AC-40/0.3	1SYF202015R3400	1	4,900
	63	30	FB202 AC-63/0.03	1SYF202015R1630 ■	1	5,370
	63	100	FB202 AC-63/0.1	1SYF202015R2630 ■	1	5,550
	63	300	FB202 AC-63/0.3	1SYF202015R3630	1	5,660

## F202 AC

Number of poles	Rated current In A	Residual rated current (mA)	Order details		Standard pack	Unit L.P. ₹
			Type code	Order code		
2P	80	30	F202 AC-80/0.03	2CSF202005R1800	1	13,980
	80	100	F202 AC-80/0.1	2CSF202005R2800	1	13,850
	80	300	F202 AC-80/0.3	2CSF202005R3800	1	13,850
	100	30	F202 AC-100/0.03	2CSF202005R1900	1	12,520
	100	100	F202 AC-100/0.1	2CSF202005R2900	1	13,100
	100	300	F202 AC-100/0.3	2CSF202005R3900	1	14,200

## FB204 and F204 AC

Number of poles	Rated current In A	Residual rated current (mA)	Order details		Standard pack	Unit MRP ₹
			Type code	Order code		
4P	25	30	FB204 AC-25/0.03	1SYF204015R1250	1	5,270
	25	100	FB204 AC-25/0.1	1SYF204015R2250	1	5,510
	25	300	FB204 AC-25/0.3	1SYF204015R3250	1	5,720
	40	30	FB204 AC-40/0.03	1SYF204015R1400 ■	1	5,370
	40	100	FB204 AC-40/0.1	1SYF204015R2400 ■	1	5,410
	40	300	FB204 AC-40/0.3	1SYF204015R3400 ■	1	5,770
	63	30	FB204 AC-63/0.03	1SYF204015R1630 ■	1	6,100
	63	100	FB204 AC-63/0.1	1SYF204015R2630 ■	1	6,530
	63	300	FB204 AC-63/0.3	1SYF204015R3630 ■	1	6,590

## F204 AC

Number of poles	Rated current In A	Residual rated current (mA)	Order details		Standard pack	Unit L.P. ₹
			Type code	Order code		
4P	80	30	F204 AC-80/0.03	2CSF204005R1800	1	14,820
	80	100	F204 AC-80/0.1	2CSF204005R2800	1	15,490
	80	300	F204 AC-80/0.3	2CSF204005R3800	1	15,650
	100	30	F204 AC-100/0.03	2CSF204005R1900	1	15,060
	100	100	F204 AC-100/0.1	2CSF204005R2900	1	16,760
	100	300	F204 AC-100/0.3	2CSF204005R3900	1	16,350
	125	30	F204 AC-125/0.03	2CSF204001R1950	1	Upon request
	125	100	F204 AC-125/0.1	2CSF204001R2950	1	
	125	300	F204 AC-125/0.3	2CSF204001R3950	1	

■ Stock items





# Residual current circuit breaker with overcurrent protection

## RCBO - DS201M series AC Type



DS201M 1P+N

### Features

- Complies to standard to IEC/EN 61009
- DS201 available in 4.5kA, 6kA & 10kA breaking capacity
- Available in AC, A and APR types to meet all protection needs
- B and C characteristics with rated current up to 40 A available on all the versions
- Contact position indicator (CPI) to indicate the exact information of the circuit-breaker status
- Equipped with an RFID tag according to standard ISO/IEC FCD 15693-3 to authenticate the product
- Bi-directional cylinder-lift terminals for easier parallel feed
- Flag indicators - Differential trip indicator - blue
- Contact position indicator - green / red

### RCBO 10kA AC Type - DS200M

Description	Current rating (A)	Residual rated current (mA)	Pack unit (Pc)	Ordering code	L.P. (₹)
DS201 M C6 AC30	6	30	1	2CSR275080R1064	5,760
DS201 M C10 AC30	10	30	1	2CSR275080R1104	5,760
DS201 M C16 AC30	16	30	1	2CSR275080R1164	5,760
DS201 M C20 AC30	20	30	1	2CSR275080R1204	5,760
DS201 M C25 AC30	25	30	1	2CSR275080R1254 ■	5,760
DS201 M C32 AC30	32	30	1	2CSR275080R1324	6,250
DS201 M C40 AC30	40	30	1	2CSR275080R1404 ■	7,420
DS201 M C6 AC100	6	100	1	2CSR275080R2064	6,480
DS201 M C10 AC100	10	100	1	2CSR275080R2104	6,480
DS201 M C16 AC100	16	100	1	2CSR275080R2164	6,480
DS201 M C20 AC100	20	100	1	2CSR275080R2204	6,480
DS201 M C25 AC100	25	100	1	2CSR275080R2254 ■	6,480
DS201 M C32 AC100	32	100	1	2CSR275080R2324	6,700
DS201 M C40 AC100	40	100	1	2CSR275080R2404 ■	7,850
DS201 M C6 AC300	6	300	1	2CSR275080R3064	6,250
DS201 M C10 AC300	10	300	1	2CSR275080R3104	6,250
DS201 M C16 AC300	16	300	1	2CSR275080R3164	6,250
DS201 M C20 AC300	20	300	1	2CSR275080R3204	6,250
DS201 M C25 AC300	25	300	1	2CSR275080R3254	6,250
DS201 M C32 AC300	32	300	1	2CSR275080R3324	6,480
DS201 M C40 AC300	40	300	1	2CSR275080R3404	7,640

# Residual current circuit breaker **NEW** with overcurrent protection

RCBO - DSB201M series AC Type (  marked)



DSB201M 1P+N

## Features

- Product Standard : IS 12640 (Part 2) : 2016, IEC 61009-1
- Type (wave form of the earth leakage sensed) : AC
- Tripping characteristic : C
- Poles : 2 Poles, 2 Modules
- Rated Current In (A) : 6, 10, 16, 20, 25, 32, 40
- Rated sensitivity IΔn (mA): 30, 100, 300
- Rated frequency (Hz) : 50
- Rated voltage Un (V) : 240 V
- Operating voltage of circuit test Ut (V) : 110
- Breaking capacity, Icn (A) acc. to IEC 61009 : 10 kA
- Rated Impulse withstand Voltage : 4 kV
- Electrical life (operations) : 10000
- Mechanical life (operations) : 20000
- Ambient temperature (with daily average  $\leq +35^{\circ}\text{C}$ ) :  $-25\dots+55^{\circ}\text{C}$
- Auxiliary devices : Compatible

## RCBO 10kA AC Type - DSB201M

Description	Current rating (A)	Residual rated current (mA)	Pack unit (Pc)	Ordering code	L.P. (₹)
DSB201 M C6 AC30	6	30	1	2CSR275075R1064	5,760
DSB201 M C10 AC30	10	30	1	2CSR275075R1104	5,760
DSB201 M C16 AC30	16	30	1	2CSR275075R1164	5,760
DSB201 M C20 AC30	20	30	1	2CSR275075R1204	5,760
DSB201 M C25 AC30	25	30	1	2CSR275075R1254 ■	5,760
DSB201 M C32 AC30	32	30	1	2CSR275075R1324	6,250
DSB201 M C40 AC30	40	30	1	2CSR275075R1404 ■	7,420
DSB201 M C6 AC100	6	100	1	2CSR275075R2064	6,480
DSB201 M C10 AC100	10	100	1	2CSR275075R2104	6,480
DSB201 M C16 AC100	16	100	1	2CSR275075R2164	6,480
DSB201 M C20 AC100	20	100	1	2CSR275075R2204	6,480
DSB201 M C25 AC100	25	100	1	2CSR275075R2254 ■	6,480
DSB201 M C32 AC100	32	100	1	2CSR275075R2324	6,700
DSB201 M C40 AC100	40	100	1	2CSR275075R2404 ■	7,850
DSB201 M C6 AC300	6	300	1	2CSR275075R3064	6,250
DSB201 M C10 AC300	10	300	1	2CSR275475R1104	6,250
DSB201 M C16 AC300	16	300	1	2CSR275075R3164	6,250
DSB201 M C20 AC300	20	300	1	2CSR275075R3204	6,250
DSB201 M C25 AC300	25	300	1	2CSR275075R3254	6,250
DSB201 M C32 AC300	32	300	1	2CSR275075R3324	6,480
DSB201 M C40 AC300	40	300	1	2CSR275075R3404	7,640

# Residual current circuit breaker **NEW** with overcurrent protection

## Factory Fitted RCBO DSB202M and DSB204M AC Type



DSB204M 

### Features

- Product Standard : IS 12640 (Part 2) : 2016, IEC 61009-1
- Type (wave form of the earth leakage sensed) : AC
- Tripping characteristic : C
- Poles : 2 Pole 4 Module, 4 Pole 8 Module
- Rated Current In (A) : 25, 40, 63
- Rated sensitivity  $I\Delta n$  (mA): 30, 100, 300
- Rated frequency (Hz) : 50
- Rated voltage Un (V) : 240 V
- Operating voltage of circuit test Ut (V) : 110
- Breaking capacity, Icn (A) acc. to IEC 61009 : 10 kA
- Rated Impulse withstand Voltage : 4 kV
- Electrical life (operations) : 10000
- Mechanical life (operations) : 20000
- Ambient temperature (with daily average  $\leq +35^{\circ}\text{C}$ ) :  $-25...+55^{\circ}\text{C}$
- Auxiliary devices : Compatible

### DSB202M 10kA AC Type Double Pole

Description	Current rating (A)	Residual rated current (mA)	Pack unit (Pc)	Ordering code	L.P. (₹)
DSB202M AC-C25/0.03	25	30	1	2CSR272027R1254	4,790
DSB202M AC-C25/0.1	25	100	1	2CSR272027R2254	5,960
DSB202M AC-C25/0.3	25	300	1	2CSR272027R3254	6,060
DSB202M AC-C40/0.03	40	30	1	2CSR272027R1404	5,970
DSB202M AC-C40/0.1	40	100	1	2CSR272027R2404	6,590
DSB202M AC-C40/0.3	40	300	1	2CSR272027R3404	6,780
DSB202M AC-C63/0.03	63	30	1	2CSR272027R1634	7,130
DSB202M AC-C63/0.1	63	100	1	2CSR272027R2634	7,630
DSB202M AC-C63/0.3	63	300	1	2CSR272027R3634	7,770

### DSB204M 10kA AC Type Four Pole

Description	Current rating (A)	Residual rated current (mA)	Pack unit (Pc)	Ordering code	L.P. (₹)
DSB204M AC-C25/0.03	25	30	1	2CSR274027R1254	6,460
DSB204M AC-C25/0.1	25	100	1	2CSR274027R2254	7,280
DSB204M AC-C25/0.3	25	300	1	2CSR274027R3254	7,500
DSB204M AC-C40/0.03	40	30	1	2CSR274027R1404	6,760
DSB204M AC-C40/0.1	40	100	1	2CSR274027R2404	7,250
DSB204M AC-C40/0.3	40	300	1	2CSR274027R3404	7,400
DSB204M AC-C63/0.03	63	30	1	2CSR274027R1634	8,000
DSB204M AC-C63/0.1	63	100	1	2CSR274027R2634	8,250
DSB204M AC-C63/0.3	63	300	1	2CSR274027R3634	8,370



# Residual current circuit breaker **NEW** with overcurrent protection

RCBO - DSB201M series A Type (  marked)



DSB201M 1P+N

## Features

- Product Standard : IS 12640 (Part 2) : 2016, IEC 61009-1
- Type (wave form of the earth leakage sensed) : A
- Tripping characteristic : C
- Poles : 2 Poles, 2 Modules
- Rated Current In (A) : 6, 10, 16, 20, 25, 32, 40
- Rated sensitivity IΔn (mA): 30, 100, 300
- Rated frequency (Hz) : 50
- Rated voltage Un (V) : 240 V
- Operating voltage of circuit test Ut (V) : 110
- Breaking capacity, Icn (A) acc. to IEC 61009 : 10 kA
- Rated Impulse withstand Voltage : 4 kV
- Electrical life (operations) : 10000
- Mechanical life (operations) : 20000
- Ambient temperature (with daily average  $\leq +35^{\circ}\text{C}$ ) :  $-25\dots+55^{\circ}\text{C}$
- Auxiliary devices : Compatible

## RCBO 10kA A Type - DSB201M

Description	Current rating (A)	Residual rated current (mA)	Pack unit (Pc)	Ordering code	L.P. (₹)
DSB201M A-C6/0.03	6	30	1	2CSR275475R1064	8,440
DSB201M A-C10/0.03	10	30	1	2CSR275475R1104	8,440
DSB201M A-C16/0.03	16	30	1	2CSR275475R1164	8,440
DSB201M A-C20/0.03	20	30	1	2CSR275475R1204	8,440
DSB201M A-C25/0.03	25	30	1	2CSR275475R1254	8,440
DSB201M A-C32/0.03	32	30	1	2CSR275475R1324	8,730
DSB201M A-C40/0.03	40	30	1	2CSR275475R1404	8,910
DSB201M A-C6/0.1	6	100	1	2CSR275475R2064	10,660
DSB201M A-C10/0.1	10	100	1	2CSR275475R2104	10,660
DSB201M A-C16/0.1	16	100	1	2CSR275475R2164	10,660
DSB201M A-C20/0.1	20	100	1	2CSR275475R2204	10,660
DSB201M A-C25/0.1	25	100	1	2CSR275475R2254	10,660
DSB201M A-C32/0.1	32	100	1	2CSR275475R2324	12,030
DSB201M A-C40/0.1	40	100	1	2CSR275475R2404	12,270
DSB201M A-C6/0.3	6	300	1	2CSR275475R3064	10,450
DSB201M A-C10/0.3	10	300	1	2CSR275475R3104	10,450
DSB201M A-C16/0.3	16	300	1	2CSR275475R3164	10,450
DSB201M A-C20/0.3	20	300	1	2CSR275475R3204	10,450
DSB201M A-C25/0.3	25	300	1	2CSR275475R3254	10,450
DSB201M A-C32/0.3	32	300	1	2CSR275475R3324	11,800
DSB201M A-C40/0.3	40	300	1	2CSR275475R3404	12,030

# Solution for unwanted tripping - AP-R type (high immunity) RCCB / RCBO

The ABB range of AP-R anti-disturbance residual current circuit-breakers and blocks was designed to overcome the problem of unwanted tripping due to overvoltages of atmospheric or operation origin.

The electronic circuit in these devices can distinguish between temporary leakage caused by disturbances on the mains and permanent leakage due to actual faults, only breaking the circuit in the latter case.

AP-R residual current circuit-breakers and blocks have a slight delay into the tripping time, but this does not compromise the safety limits set by the Standards in force (release time at  $2 I_{\Delta n} = 150$  ms).

Compared with standard type breakers, AP-R residual current breakers are therefore characterised, for any given sensibility, by:

- Higher residual trip current
- Tripping time delay
- Better resistance to overvoltages, harmonics and impulse disturbances

Guaranteeing conventional residual current protection, their installation in the electrical circuit therefore allows any unwanted tripping to be avoided in domestic and industrial systems in which service continuity is essential.

This delay makes the AP-R residual current devices especially suited for installations involving motor starters/variable speed drives, fluorescent lamps or IT/electronic equipment.

The use of multiple electronic reactors for the supply of fluorescent lamps instead generates permanent leakage currents and inrush currents that can cause nuisance tripping of a standard residual current circuit breaker.

IT system loads and other electronic equipment (e.g. dimmers, computers, inverters) with capacitive input filters connected between the phases and ground can also generate permanent earth leakage currents whose sum may provoke the nuisance tripping of a standard residual current circuit breaker. For these situations, the AP-R breakers allow a greater number of devices to be connected to the installation.

Frequency converters include a rectifier section and an inverter section.

In case of fault within a single-phase frequency converter AP-R type RCDs provide complete protection, because an earth fault occurring downstream the inverter, produces an earth fault current with multi-frequency shape with high amount of harmonics.

While, in case of fault within a three-phase frequency converter, B type RCDs ensure complete protection because in case of insulation fault between the rectifier and the inverter or downstream the inverter we can have a smooth DC earth fault current.

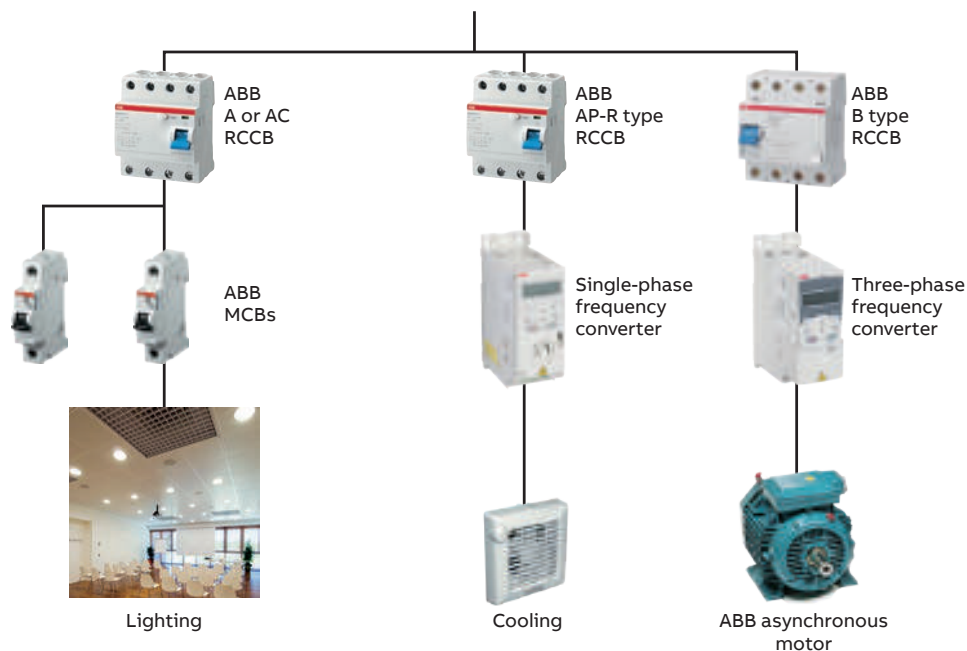

# RCCB - F200 series: AP-R (high immunity)



F202A

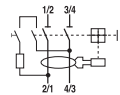

F204A

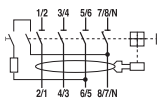

Function: protection against the effects of sinusoidal alternating and direct pulsating earth fault currents, providing the best compromise between safety and continuity in the service, thanks to the resistance to unwanted trippings; protection against indirect contacts and additional protection against direct ( $I_{\Delta n}=30$  mA) contacts.

Application: residential, commercial, industrial Standard: IEC/EN 61008

Surge current resistance (wave 8/20)=3000 A Marking: according to EN 61008

## RCCB - F200 series

Description	Current rating (A)	Residual rated current (mA)	Packing	Ordering code	L.P. (₹)
<b>Two pole</b>					
F202 A-25/0.03 AP-R	25	30	1	2CSF202401R1250	8,700
F202 A-40/0.03 AP-R	40	30	1	2CSF202401R1400	9,160
F202 A-63/0.03 AP-R	63	30	1	2CSF202401R1630	11,060
F202 A-80/0.03 AP-R	80	30	1	2CSF202401R1800	15,330
F202 A-100/0.03 AP-R	100	30	1	2CSF202401R1900	17,160
<b>Four pole</b>					
F204 A-25/0.03 AP-R	25	30	1	2CSF204401R1250	10,700
F204 A-40/0.03 AP-R	40	30	1	2CSF204401R1400	11,000
F204 A-63/0.03 AP-R	63	30	1	2CSF204401R1630	12,490
F204 A-80/0.03 AP-R	80	30	1	2CSF204401R1800	18,740
F204 A-100/0.03 AP-R	100	30	1	2CSF204401R1900	20,650
F204 A-125/0.03 AP-R	125	30	1	2CSF204401R1950	Upon Request

## RCBO - DS200 series APR type (high immunity)

Function: protection against the effects of sinusoidal alternating and direct pulsating earth fault currents, providing an optimal compromise between safety and continuity of service, thanks to the resistance to unwanted tripping; protection against indirect contact and additional protection against direct ( $I_{\Delta n}=30$  mA) contact; protection and isolation of resistive and inductive loads.

Application: residential, commercial, industrial Standard: IEC/EN 61009

$I_{cn}=10$  kA

## RCBO - DS200 series APR type

Description	Current rating (A)	Residual rated current (mA)	Packing	Ordering code	L.P. (₹)
DS201 M C6 APR30	6	30	1	2CSR275480R1064	9,930
DS201 M C10 APR30	10	30	1	2CSR275480R1104	9,930
DS201 M C16 APR30	16	30	1	2CSR275480R1164	9,930
DS201 M C20 APR30	20	30	1	2CSR275480R1204	9,930
DS201 M C25 APR30	25	30	1	2CSR275480R1254	9,930
DS201 M C32 APR30	32	30	1	2CSR275480R1324	10,270
DS201 M C40 APR30	40	30	1	2CSR275480R1404	10,480
DS201 M C6 APR100	6	100	1	2CSR275480R2064	12,540
DS201 M C10 APR100	10	100	1	2CSR275480R2104	12,540
DS201 M C16 APR100	16	100	1	2CSR275480R2164	12,540
DS201 M C20 APR100	20	100	1	2CSR275480R2204	12,540
DS201 M C25 APR100	25	100	1	2CSR275480R2254	12,540
DS201 M C32 APR100	32	100	1	2CSR275480R2324	14,150
DS201 M C40 APR100	40	100	1	2CSR275480R2404	14,440
DS201 M C6 APR300	6	300	1	2CSR275480R3064	12,290
DS201 M C10 APR300	10	300	1	2CSR275480R3104	12,290
DS201 M C16 APR300	16	300	1	2CSR275480R3164	12,290
DS201 M C20 APR300	20	300	1	2CSR275480R3204	12,290
DS201 M C25 APR300	25	300	1	2CSR275480R3254	12,290
DS201 M C32 APR300	32	300	1	2CSR275480R3324	13,880
DS201 M C40 APR300	40	300	1	2CSR275480R3404	14,150



DS201M APR-1P+N

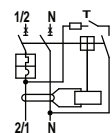



## System pro M

Accessories for MCB's-SB200M/S200M,  
RCCB's- FB200/F200, Switch Disconnecter-  
SDB200/E200, RCBO DS200M, DSB201M,  
DSB202M and DSB204M



Thanks to the variety of control and monitoring accessories which enable you to build different monitoring control logics of the protection devices.



— S2C-H6...  
Auxiliary  
contact



— S2C-S/H6R  
Signal/auxiliary  
contacts



— S2C-A  
Shunt trip



— S2C-UA  
Under voltage  
release



— S2C-OVP  
Over voltage  
release



— S2C-CM4  
Motor operating  
device



— S2C-BP  
Mechanical  
tripping device

# System pro M

## Accessories for MCB's-SB200M/SB200 DC/S200M, Switch Disconnector SDB200/E200

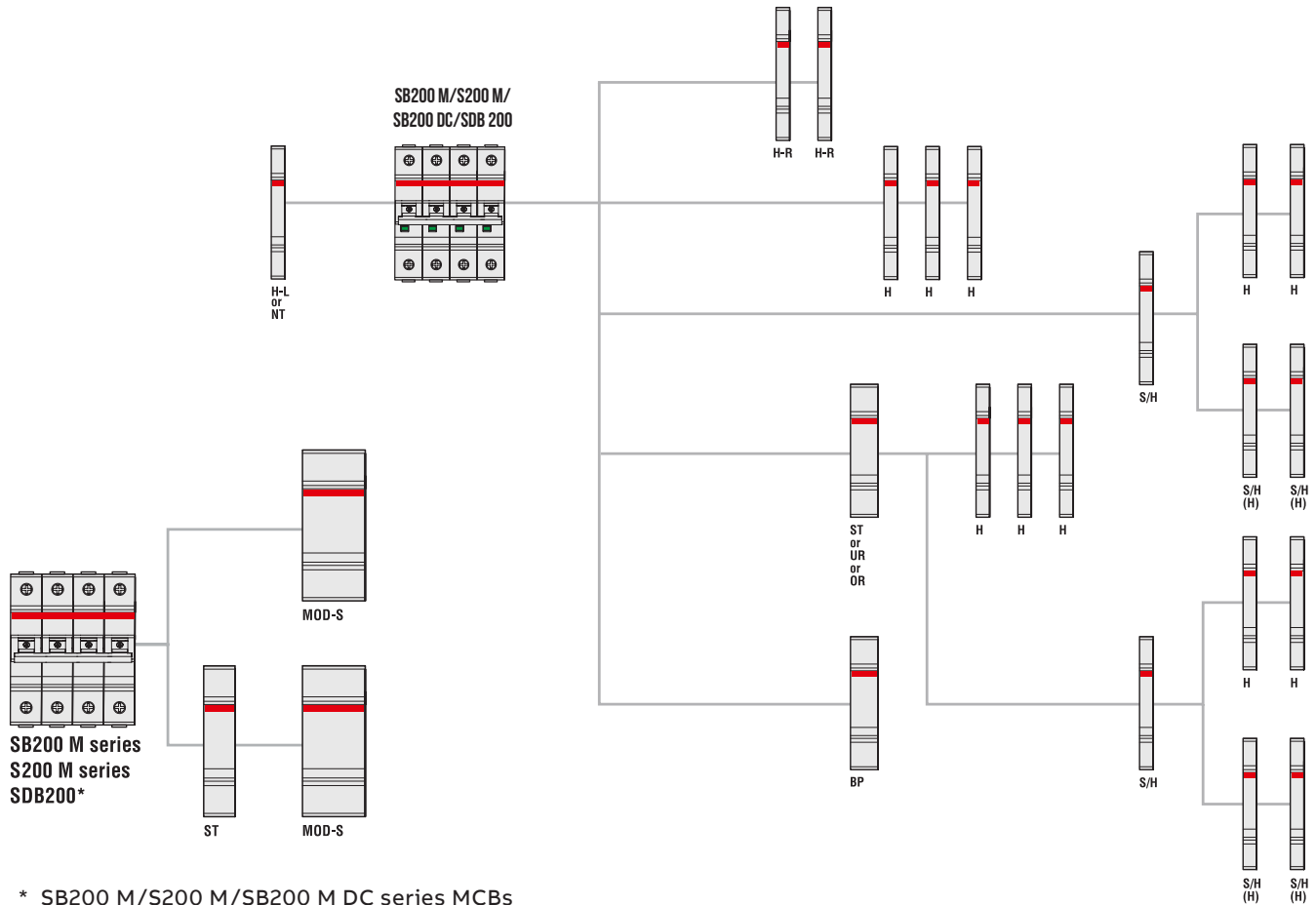

\* SB200 M/S200 M/SB200 M DC series MCBs and SDB200 switch disconnectors up to 3P or 2P+ST can be coupled with MOD-S

H	Auxiliary contact	S2C-H6R
H-R	Auxiliary contact	S2C-H6-...R
S/H	Signal/Auxiliary contact	S2C-S/H6R
S/H (H)	Signal/Auxiliary contact used as auxiliary contact	S2C-S/H6R
ST	Shunt trip for SB200 MCB	S2C-A...
UR	Undervoltage release	S2C-UA
OR	Overvoltage release	S2C-OVP
H-L	Auxiliary contact for SB200 MCBs to be mounted on the left	S2C-H...L
BP	Mechanical tripping device	S2C-BP
NT	Switched neutral	S2C-Nt

# System pro M

## Accessories for RCCB's FB200 and F200

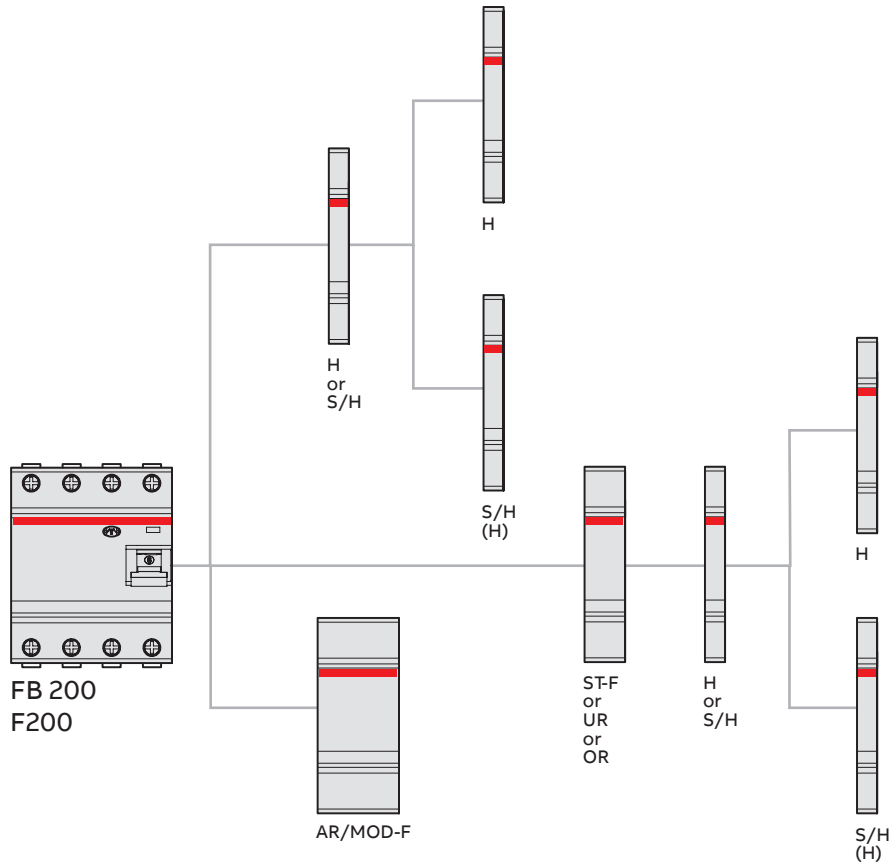

H	Auxiliary contact	S2C-H6R
S/H	Signal/Auxiliary contact	S2C-S/H6R
S/H (H)	Signal/Auxiliary contact used as auxiliary contact	S2C-S/H6R
UR	Undervoltage release	S2C-UA
OR	Overvoltage release	S2C-OVP
AR	Auto reclosing unit	F2C-ARI
MOD-F	Motor operating device	F2C-CM
ST-F	Shunt trip for FB200 RCCB	F2C-A

# Auxiliary elements and accessories for MCBs and RCDs

## Selection tables

Combination of auxiliary elements with DS201M and DSB201M

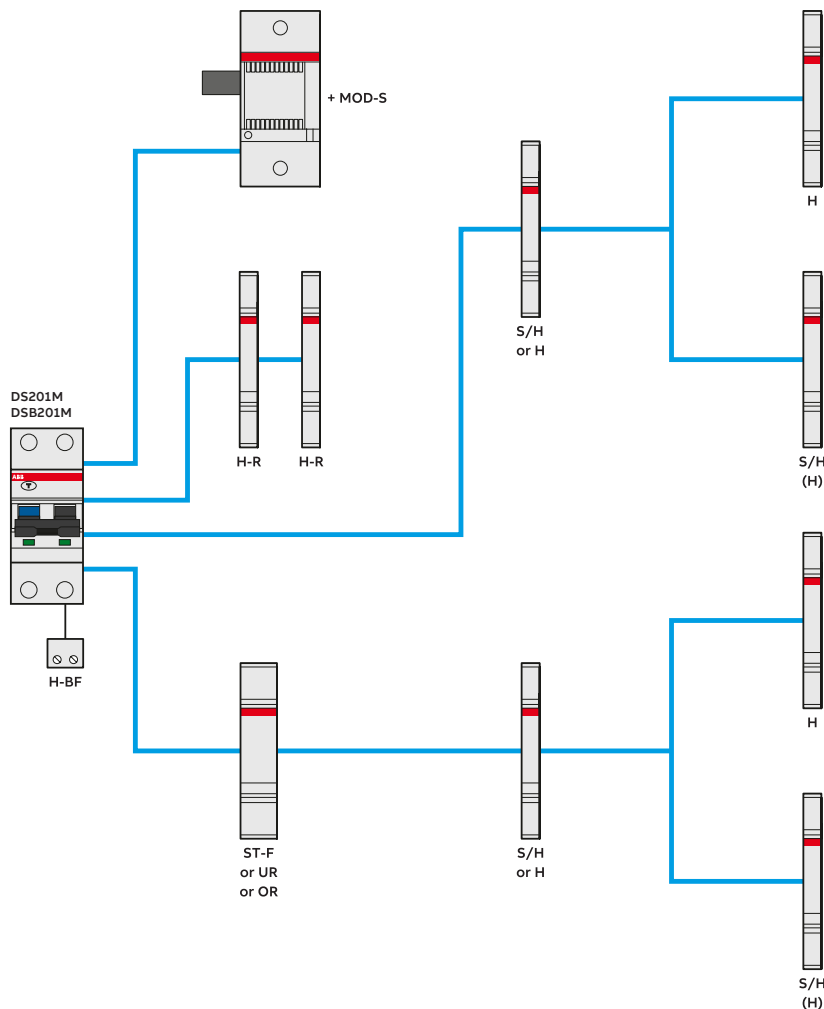

H	Auxiliary contact	S2C-H6R
H-R	Auxiliary contact	S2C-H6-xxR
S/H	Signal / auxiliary contact	S2C-S/H6R
S/H (H)	Signal / auxiliary contact used as auxiliary contact	S2C-S/H6R
ST-F	Shunt Trip	F2C-A
UR	Undervoltage release	S2C-UA
OR	Oversvoltage release	S2C-OVP
H-BF	Auxiliary contact for bottom fitting (only DS201 (2019))	S2C-H01 / S2C-H10
MOD-S	Motor operating device (for DS201 (2019))	S2C-CM2/3
MOD-S	Motor operating device (for DS201 and DS202C)	DS2C-CM

# Accessories

for SB200 M/SB200 DC, switch disconnecter  
SDB200/E200 RCBO DS201M and DSB201M



SA 1

### Locking device for MCBs and switches

Prevents unauthorised or dangerous operation of the operating lever. An adaptor makes it possible to block the operating lever whether switched ON or OFF. The lever is blocked with a padlock having a cross bar section of 3 or, as the case may be, 6 mm max. For multipole devices, one lock may be fitted per pole.

The lock adaptor can be used for all MCBs of the SB200M, SB200 DC, switch disconnecter SDB200, RCBO DS201M, DSB201M and E200.



SA 2

Description	Order details		Standard pack	L.P. ₹
	Type code	Order code		
Locking Device 3mm	SA 1	GJF1101903R0001	10	710
Lock Adaptor 6mm	SA 1E	GJF1101903R0004	10	700
Padlock with 2 keys	SA 2	GJF1101903R0002	10	2,280
Padlock, identical locking with 2 keys	SA 2 i	GJF1109999R0001	10	1,730
Lock adapto incl. padlock with 3 keys in transparent box	SA 3	GJF1101903R0003	10	2,160

# Auxiliary elements for

MCB's SB200M/SB200 DC/S200M, switch disconnector SDB200, RCCB-FB200/F200, RCBO-DS201M and DSB201M



2C5C400468F0201

S2C-S/H6R

### Signal/auxiliary contacts

Signal contacts indicate if a device trips due to a failure (overcurrent/short-circuit for MCBs and RCBOs; earth fault for RCCBs and RCBOs). Auxiliary contacts indicate the position of the contacts, independent if a failure occurred or the device was operated manually.

### S2C-S/H6R:

Choice through a selector between signal and auxiliary contact.

### S2C-H6R and S2C-HxxR:

Auxiliary contacts with contact configuration according to the following table. All right-side mounted contacts are suitable for MCBs, RCDs, switch disconnectors SDB200 according the "Selection tables" which are displayed at the beginning of chapter 4.

### S2C-HxxL:

Auxiliary contacts with contact configuration according to the following table. These contacts are left-side mounted and fit to SB200 MCBs and switch disconnectors SDB200 according to the "Selection tables". Especially when using a motor operating device this is a possibility to add a contact as the right side mounted ones do not fit within this combination.



2C5C400468F0201

S2C-H6...

Description	Bbn 4016779	Order details		Standard pack	L.P. ₹
	EAN	Type code	Order code		
Signal contact/ auxiliary switch 1CO	563819	S2C-S/H6R	2CDS200922R0001 ■	1	2,040
Auxiliary contact 1CO	563826	S2C-H6R	2CDS200912R0001 ■	1	1,130
Auxiliary contact 1NO/1NC	697941	S2C-H6-11R	2CDS200946R0001 ■	1	1,160
Auxiliary contact 2NO	697958	S2C-H6-20R	2CDS200946R0002	1	1,170
Auxiliary contact 2NC	697965	S2C-H6-02R	2CDS200946R0003	1	1,170

### Auxiliary contacts mounting on the left side

Description	Bbn 4016779	Order details		Standard pack	L.P. ₹
	EAN	Type code	Order code		
Auxiliary contact 1 NO/1NC	648820	S2C-H11L	2CDS200936R0001	1	1,310
Auxiliary contact 2 NO	648837	S2C-H20L	2CDS200936R0002	1	1,290
Auxiliary contact 2 NC	648844	S2C-H02L	2CDS200936R0003	1	1,290

## Auxiliary elements for

# MCB's SB200M, SB200M DC, switch disconnecter SDB200/E200



S2C-A

### Shunt trips

Function: remote opening of the device when a voltage is applied. Suitable for MCBs SB200 series, SDB200 switch disconnectors series.

Shunt trips use a coil like MCBs for tripping. To trip a shunt, it is necessary to choose the right voltage and make sure the corresponding  $I_{bmax}$  (as mentioned in the table above) is provided by the power supply used. If the power supply can provide higher currents the shunt trip will reduce the current to  $I_{bmax}$  due to its internal resistance.

As soon as the shunt trips, the contact inside is open – the electrical circuit is disconnected even if the shunt trip is still powered on. The free-tripping mechanism of the shunt trip allows a restart of the MCB only after the shunt trip gets no external release signal anymore.

#### Auxiliary contacts mounting on the left side

Rated voltage	Bbn 4016779	Order details		Standard pack	L.P. ₹
	EAN	Type code	Order code		
AC/DC 12...60 V	570992	S2C-A1	2CDS200909R0001 ■	1	5,080
AC 110...415 V/DC110...250 V	571005	S2C-A2	2CDS200909R0002 ■	1	

## Auxiliary elements for

# RCCBs FB200, F200, RCBOs DS201M and DSB201M



F2C-A

### Shunt trips

Function: remote opening of the device when a voltage is applied.

Suitable for RCCBs FB200, F200 series, RCBOs DS201M and DSB201M

#### Auxiliary contacts mounting on the left side

Rated voltage	Bbn 8012542	Order details		Standard pack	L.P. ₹
	EAN	Type code	Order code		
AC/DC 12...60V	974901	F2C-A1	2CSS200933R0011	1	6,190
AC 110...415V / DC 110...250V	975007	F2C-A2	2CSS200933R0012	1	

# Auxiliary elements for

MCB's SB200M, SB200 DC, switch disconnecter SDB200/E200, RCCB FB200, F200, RCBO DS201M and DSB201M



S2C-UA

2CSS400325F0201

## Undervoltage releases

Function: protection of the load in the event of a voltage drop (between 70% and 35% of its rated value); positive safety (devices tripping when the voltage is disconnected) emergency stop by means of a button. Suitable for MCBs SB200 series, RCCBs FB200 series and RCBOs DS201M, DSB201M, SDB200 switch disconnectors series.

Rated voltage	Bbn 8012542	Order details		Standard pack	L.P. ₹
	EAN	Type code	Order code		
12V DC	839705	S2C-UA 12 DC	2CSS200911R0001	1	6,520
24V AC	839804	S2C-UA 24 AC	2CSS200911R0002	1	
24V DC	896401	S2C-UA 24 DC	2CSS200911R0007	1	
48V AC	839903	S2C-UA 48 AC	2CSS200911R0003	1	
48V DC	896500	S2C-UA 48 DC	2CSS200911R0008	1	
110V AC	840008	S2C-UA 110 AC	2CSS200911R0004 ■	1	
110V DC	896609	S2C-UA 110 DC	2CSS200911R0009	1	
230V AC	840107	S2C-UA 230 AC	2CSS200911R0005 ■	1	
230V DC	896708	S2C-UA 230 DC	2CSS200911R0010	1	
400V AC	840206	S2C-UA 400 AC	2CSS200911R0006	1	

## Overvoltage release

Function: monitoring voltage between the neutral and phase; when an overvoltage reaches the threshold value, the OVP device causes the tripping of the associated MCB or RCCB. Suitable for MCBs of the SB200 series up to 63 A, and RCCBs of the FB200 series up to 100 A and RCBOs DS201M, DSB201M Suitable for SDB200 switch disconnectors series.

Description	Bbn 8012542	Order details		Standard pack	L.P. ₹
	EAN	Type code	Order code		
Overvoltage release (max. tripping voltage AC: 275V)	748137	S2C-OVP1	2CSS200910R0005	1/5	7,770
Overvoltage release (max. tripping voltage AC: 290V)	952039	S2C-OVP2	2CSS200993R0005	1/5	



S2C-Nt

2CSS400055F0201

## Hand operated neutral left side mounted

S2C-Nt		
Rated current	A	max. 40
Terminal	mm <sup>2</sup>	10; cage terminal
Tightening torque	Nm	1.2
Dimensions (H x D x W)	mm	85 x 69 x 8.8

## Hand operated neutral

The hand operated neutral has to be mounted to the left side of the MCB and be snapped onto the DIN rail. It is used for measuring duties where the neutral conductor must be in the open position. Due to the special design of the handle - when switching ON the MCB - the neutral will make before the MCB is closed. Suitable for SDB200 switch disconnecter series. The S2C - Nt is not to switch with a tool (screwdriver).

Description	Bbn 4016779	Order details		Standard pack	L.P. ₹
	EAN	Type code	Order code		
Max 40A	647625	S2C-Nt	2CDS200918R0001	1	1,170

■ Stock items



# Accessories

## Rotary operating mechanism for SB200M



S2C-DH

### Rotary operating mechanism (usable just with SB200/S200 devices)

For the actuation of 2-, 3- or 4pole miniature circuit-breakers in closed distribution boards for driveaxles of 5 or 6 mm<sup>2</sup> (square)

Description	Bbn 4012233	Order details		Standard pack	L.P. ₹
	EAN	Type code	Order code		
Rotary operating mechanism	57960 5	S2C-DH	GHS2001901R0003	1	Upon request

Note: S2C-DH cannot be used on DS200

### Handles

Handle IP 65, 65 x 65 mm, padlockable with max. 3 padlocks (bail diameter 5 - 8 mm), door interlock in ON-position, adjustable\*



OH

Color	Suitable for switches	Bbn 4012233	Order details		Standard pack	L.P. ₹
		EAN	Type code	Order code		
Black	OT16...40F	40978 8	OHBS2AJ	1SCA105213R1001	1	Upon request
Yellow-red	OT16...40F	41226 9	OHYS2AJ	1SCA105296R1001	1	
Silver	OT16...40F	41199 6	OHSS2AJ	1SCA105278R1001	1	
Grey	OT16...40F	41186 6	OHGS2AJ	1SCA105265R1001	1	

Handle IP 65, 65 x 65 mm, padlockable with max. 3 padlocks (bail diameter 5 - 8 mm), door interlock in ON-position

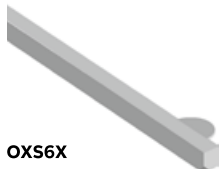

OXS6X

Color	Suitable for switches	Bbn 4012233	Order details		Standard pack	L.P. ₹
		EAN	Type code	Order code		
Black	OT16...40F	41140 8	OHBS2AJ1	1SCA105215R1001	1	Upon request
Yellow-red	OT16...40F	41227 6	OHYS2AJ1	1SCA105297R1001	1	
Silver	OT16...40F	41210 8	OHSS2AJ1	1SCA105279R1001	1	
Grey	OT16...40F	41187 3	OHGS2AJ1	1SCA105266R1001	1	

\* OH\_2\_J enables selection of MCB behavior when opening panel door (remain switched on or switch off).  
OH\_2\_J1 will cause MCB to switch off when opening panel door.

### Axle extension

Type and order numbers are for one piece. For selector type handles. Shaft diameter 6 mm.

Length	Suitable for switches	Bbn 4012233	Order details		Standard pack	L.P. ₹
		EAN	Type code	Order code		
85	OT16...40F	36571 8	OXS6X85	1SCA101647R1001	10	Upon request
105	OT16...40F	42411 8	OXS6X105	1SCA108043R1001	10	
120	OT16...40F	36578 7	OXS6X120	1SCA101654R1001	10	
130	OT16...40F	36577 0	OXS6X130	1SCA101655R1001	10	
160	OT16...40F	36580 0	OXS6X160	1SCA101656R1001	10	
180	OT16...40F	36583 1	OXS6X180	1SCA101659R1001	10	
250	OT16...40F	36584 8	OXS6X250	1SCA101660R1001	10	
330	OT16...40F	36585 5	OXS6X330	1SCA101661R1001	10	

## Auxiliary elements for

MCB's SB200M, SB200 DC, switch disconnecter SDB200, RCCB's FB200, F200, RCBO's DS201M and DSB201M



S2C-CM4

2CSS204997R0013

### Motor operating devices

Function: S2C-CM, F2C-CM and DS2C-CM allow the remote control (opening or closing) of the coupled device. Suitable for SB200 series MCBs and SDB200 switch disconnectors, FB200 RCCBs, RCBOs DS201M and DSB201M

Description	Bbn 8012542 EAN	Order details		Standard pack	L.P. ₹
		Type code	Order code		
Motor operating device for 1P S200 series MCBs and SD200 switch disconnectors	026259	S2C-CM1	2CSS201997R0013	1	Upon request
Motor operating device for 2P and 3P S200 series MCBs and SD200 switch disconnectors	026358	S2C-CM2/3	2CSS203997R0013	1	
Motor operating device for 4P S200P MCBs	026457	S2C-CM4	2CSS204997R0013	1	
Motor operating device for 2P and 4P F200 RCCBs	026556	F2C-CM	2CSF200997R0013	1	
Motor operating device for 1P+N and 2P DS201, DS202C RCBOs	135951	DS2C-CM	2CSR201997R0013	1	
Motor operating device for F200 125A RCCB	020721	F2-125A-24V-CM4	2CSF200997R1214	1	
Motor operating device for F200 125A RCCB	600626	F2-125A-230V-CM4	2CSF200997R1205	1	



F2C-ARI

2CSS4100247F0201

### Auto-reclosing units

Function: F2C-ARI and F2C-ARI30 allow the auto-reclosing of the coupled device in case of unwanted tripping. Suitable for F 200 RCCBs up to 100 A.

Description	Bbn 8012542 EAN	Order details		Standard pack	L.P. ₹
		Type code	Order code		
Auto-reclosing unit for 2P and 4P F200 RCCBs	026655	F2C-ARI	2CSF200996R0013	1	Upon request
Auto-reclosing unit for 2P and 4P F200 RCCBs (30")	064350	F2C-ARI30	2CSF200995R0013	1	

# Auxiliary elements for RCCB's FB200 and F200



F2C-ARH

2CSF400678R0001

## Home automatic resetting unit (for domestic and similar applications)

Function: it recloses the associated residual current device, only after having checked that there are no effective faults in the system protected by the RCCB.

Suitable for 2-pole RCCB series with 30 mA or 100 mA sensitivities, max 63 A

Description	Bbn 8012542	Order details		Standard pack	L.P. ₹
	EAN	Type code	Order code		
Home automatic resetting unit (30 mA)	732433	F2C-ARH	2CSF200992R0005	1	Upon request
Home automatic resetting unit (100 mA)	658535	F2C-ARH100	2CSF200990R0005	1	



F2C-ARH-T

2CSF40004HF0202

## Home automatic resetting unit with autotest (for domestic and similar applications)

Function: it recloses the associated residual current device, only after having checked that there are no effective faults in the system protected by RCCB.

Suitable for 2-pole RCCB series with 30 mA or 100 mA sensitivities, max 63 A.

F2C-ARH-T allows the RCCB automatic test every six months.

Description	Bbn 8012542	Order details		Standard pack	L.P. ₹
	EAN	Type code	Order code		
Home automatic resetting unit (30 mA) with RCCB autotest	733232	F2C-ARH-T	2CSF200991R0005	1	Upon request
Home automatic resetting unit (100 mA) with RCCB autotest	593836	F2C-ARH-T100	2CSF200989R0005	1	

# Auxiliary elements for MCB's S800 series



S800-AUX

## Auxiliary contact

Description	Order details	Packing	Ordering code	L.P. (₹)
Auxiliary contact	S800-AUX	1	2CCS800900R0011 ■	3,980



S800-AUX/ALT

## Combined auxiliary and signal contact

Description	Order details	Packing	Ordering Code	L.P. (₹)
Auxiliary/signal contact	S800-AUX/ALT	1	2CCS800900R0021	4,750

■ Stock items

# Wiring diagram

## System Pro M

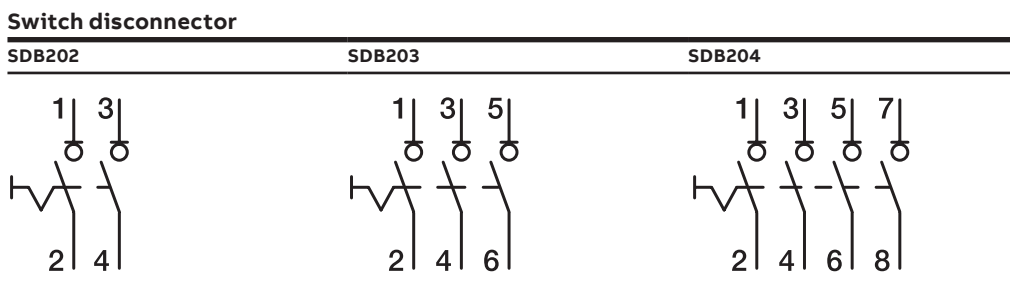
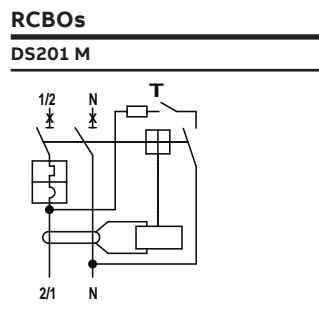
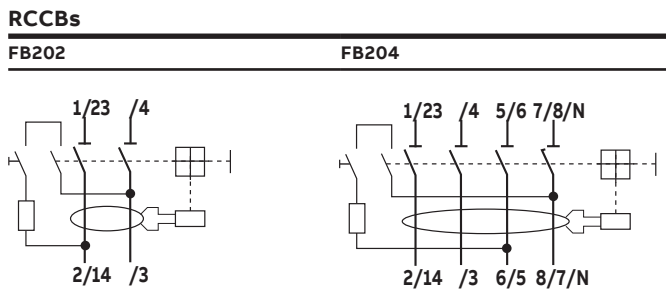
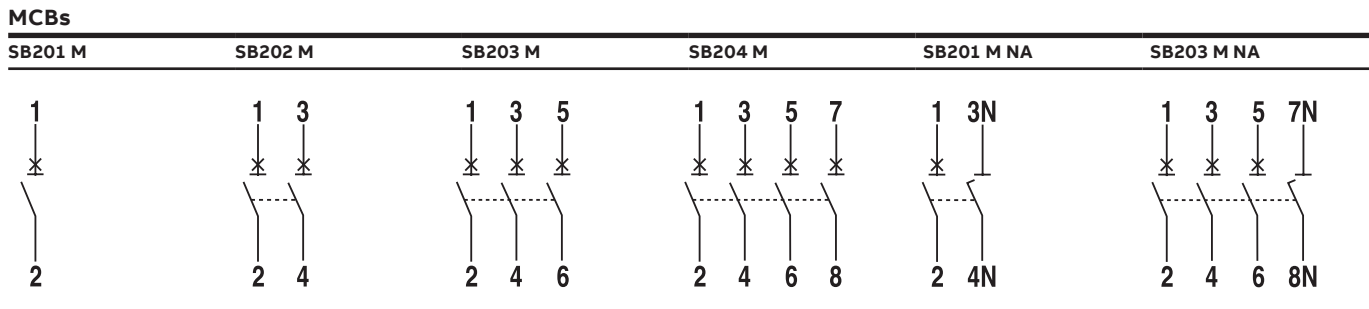

# Wiring diagram

## SB200 DC

### Example for permissible voltages between the conductors depending on the number of poles and circuit layout:

voltage between conductors	$U_n$	250 V-	500 V-	500 V-	500 V-
voltage between conductors and earth	$U_n$	250 V-	250 V-	500 V-	250 V-
MCB		1-pole SB200 DC	2-pole SB200 DC	2-pole SB200 DC	2-pole SB200 DC
supply from below					
supply from above					

### Supply and load connections

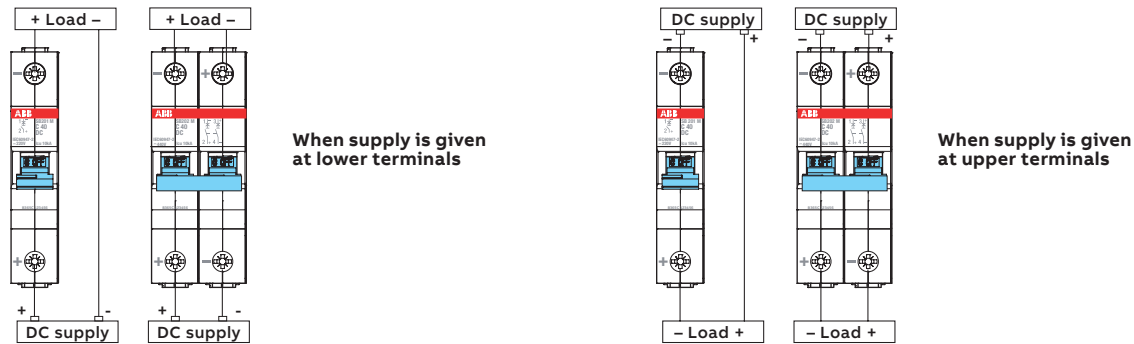

### Auxiliary elements

S2C-S/H6R			S2C-H6R		S2C-H-11R		S2C-H6-20R	
Used as signal contact	Automatic opening	Manual opening	Used as auxiliary contact	Automatic opening	Used as auxiliary contact	Automatic opening	Used as auxiliary contact	Automatic opening

### Auxiliary elements

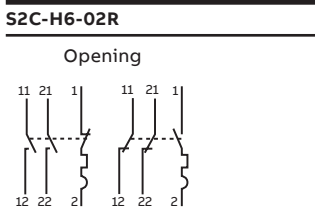

# Overall dimensions

## System Pro M

### MCB SB200 M and Switch disconnecter SDB200

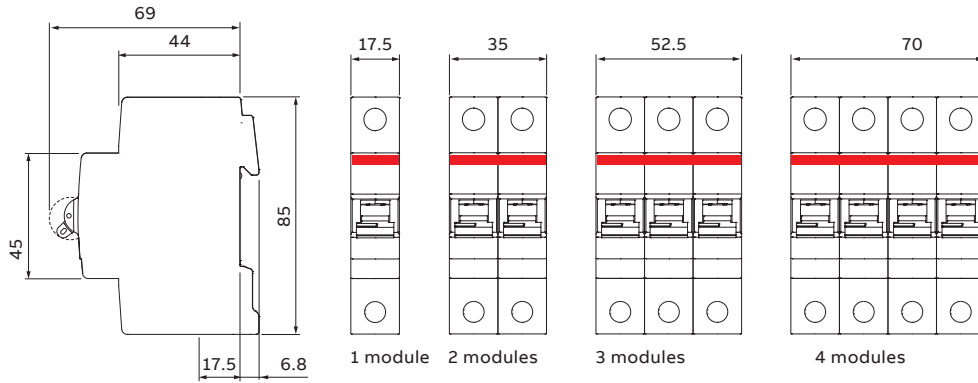

### MCB SB200 DC

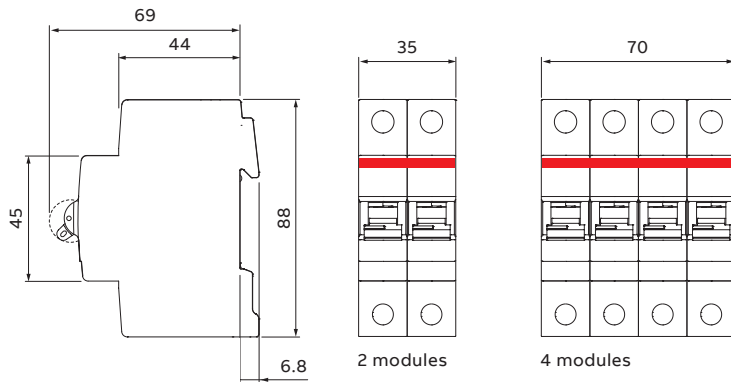

### RCCB FB200

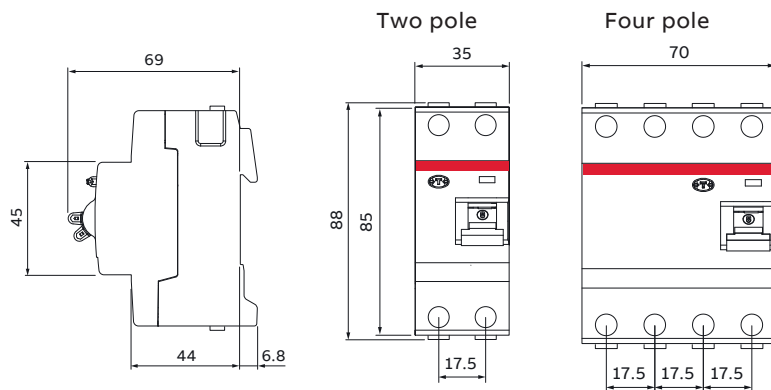

### RCBO DS201 M

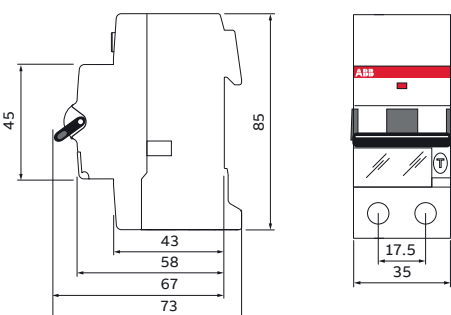

# Overall dimensions

## MCB - (S200 M and S200)

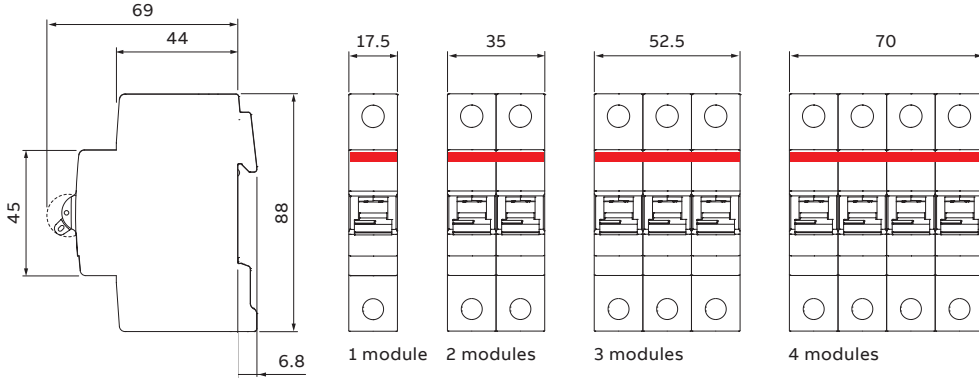

## RCCB - (F200)

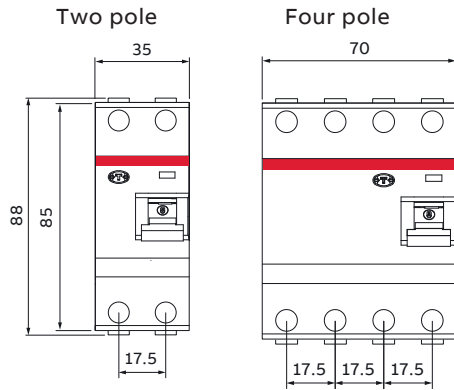
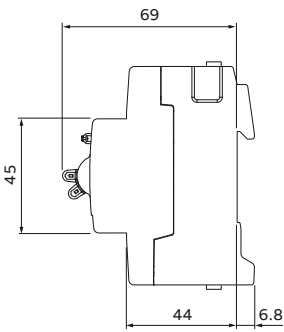

## RCBO (DS200)

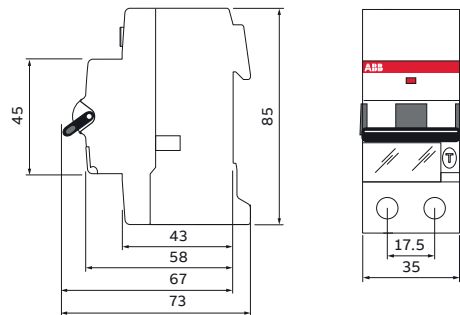

## DDA 200

Two pole  
In=25-63 A

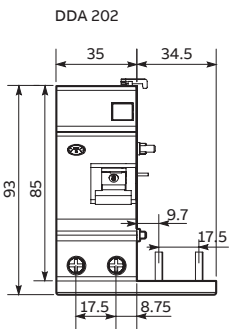

Four pole  
In=25-40 A

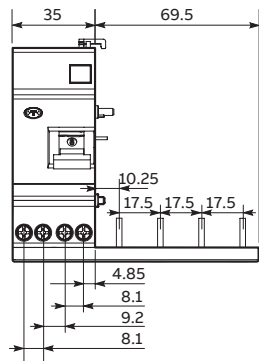

Four pole  
In=63 A

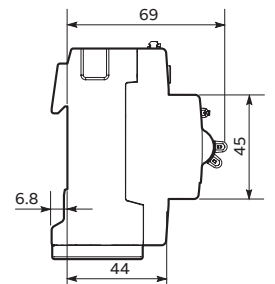
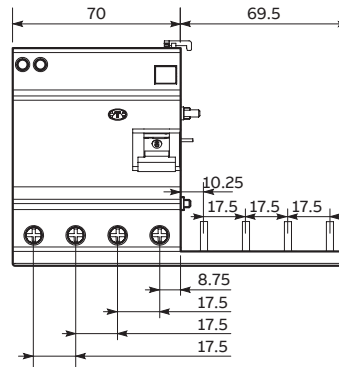

# Surge protection devices - The new OVR QuickSafe®

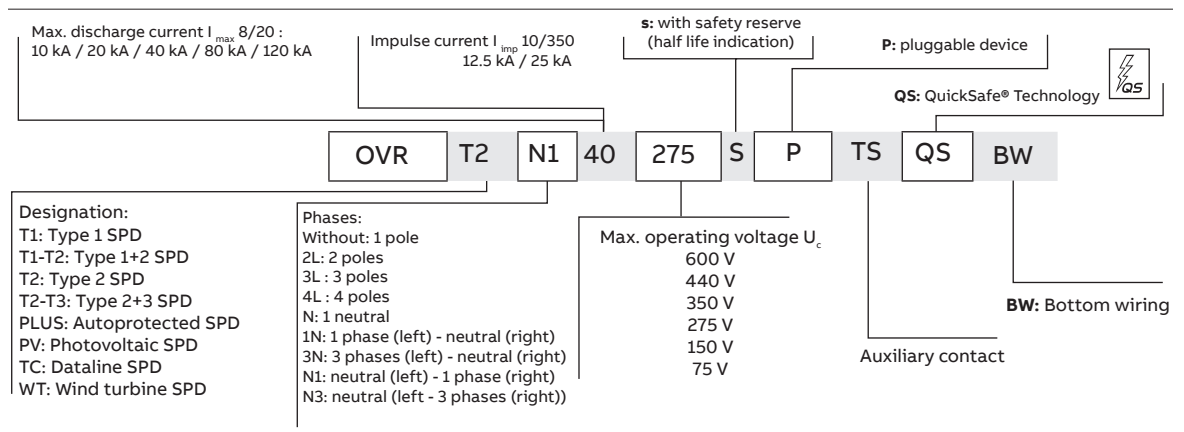

## Type 1+2 - Metal oxide varistor

Type 1+2 surge protective devices are designed to discharge high current surges without any destruction of the installation. These surge protective devices are characterized by their capacity to withstand impulse current with 10/350  $\mu$ s wave form which simulate natural lightning current.

### Three pole + neutral



OVR Type 1

Description	Max. continuous operating voltage $U_c$ (V)	"I imp in kA (10/350us wave)"	"I max in kA (8/20us wave)"	Pole	No. of modules	Ordering code	L.P. (₹)
OVR T1-T2 3N 12.5-275s P QS	275	12.5	80	3+1	4	2CTB815710R1900 ■	30,070
OVR T1-T2 3N 12.5-275s P TS QS	275	12.5	80	3+1	4	2CTB815710R0700	34,590
OVR T1-T2 3N 12.5-440s P QS	440	12.5	80	3+1	4	2CTB815710R4800	36,090
OVR T1-T2 3N 12.5-440s P TS QS	440	12.5	80	3+1	4	2CTB815710R3600	41,490

## Type 2 - Metal oxide varistor

Type 2 SPDs can be installed at the sub-distribution switch board for protection of electrical installation and equipments against indirect lightning and switching surges.

### Single pole



OVR Type 2

Description	Max. continuous operating voltage $U_c$ (V)	I max in kA (8/20us wave)	No. of Modules	Ordering code	L.P. (₹)
OVR T2 40-275 P QS	275	40	1	2CTB803871R2300 ■	5,090
OVR T2 40-275s P QS	275	40	1	2CTB815704R1200	7,540
OVR T2 40-275 P TS QS	275	40	1	2CTB803871R1700	6,490
OVR T2 40-440 P QS	440	40	1	2CTB803871R1200	5,190
OVR T2 40-440s P QS	440	40	1	2CTB815704R4100	7,160
OVR T2 80-275s P QS	275	80	1	2CTB815708R1200	7,780
OVR T2 80-275s P TS QS	275	80	1	2CTB815708R0000	9,590
OVR T2 80-440s P QS	440	80	1	2CTB815708R4100	7,050
OVR T2 80-440s P TS QS	440	80	1	2CTB815708R2900	8,830

■ Stock items



# Surge protection devices (OVR)



OVR Type 2

## Single pole + neutral

Description	Max. continuous operating voltage U <sub>c</sub> (V)	I max in kA (8/20us wave)	No. of Modules	Ordering code	L.P. (₹)
OVR T2 1N 40-275 P QS	275	40	2	2CTB803972R1100 ■	10,830
OVR T2 1N 40-275s P QS	275	40	2	2CTB815704R1400	13,660
OVR T2 1N 40-275 P TS QS	275	40	2	2CTB803972R0500	12,300
OVR T2 1N 40-275s P TS QS	275	40	2	2CTB815704R0200	14,950
OVR T2 1N 40-350 P QS	350	40	2	2CTB803982R1100	11,700
OVR T2 1N 40-350 P TS QS	350	40	2	2CTB803982R0500	13,290
OVR T2 1N 80-275s P QS	275	80	2	2CTB815708R1400	14,390
OVR T2 1N 80-275s P TS QS	275	80	2	2CTB815708R0200	15,880

## Three pole + neutral



OVR Type 2

Description	Max. continuous operating voltage U <sub>c</sub> (V)	I max in kA (8/20us wave)	No. of modules	Ordering code	L.P. (₹)
OVR T2 3N 40-275 P QS	275	40	4	2CTB803973R1100 ■	18,520
OVR T2 3N 40-275s P QS	275	40	4	2CTB815704R2000	26,390
OVR T2 3N 40-275 P TS QS	275	40	4	2CTB803973R0500	23,570
OVR T2 3N 40-275s P TS QS	275	40	4	2CTB815704R0800	30,930
OVR T2 3N 40-350 P QS	350	40	4	2CTB803983R1100	20,010
OVR T2 3N 40-350 P TS QS	350	40	4	2CTB803983R0500	30,020
OVR T2 3N 40-440 P QS	440	40	4	2CTB803973R1400	19,070
OVR T2 3N 40-440 P TS QS	440	40	4	2CTB803973R1500	23,870
OVR T2 3N 40-440s P TS QS	440	40	4	2CTB815704R3700	55,680
OVR T2 3N 80-275s P QS	275	80	4	2CTB815708R2000	27,590
OVR T2 3N 80-275s P TS QS	275	80	4	2CTB815708R0800	32,870
OVR T2 3N 80-440s P QS	440	80	4	2CTB815708R4900	24,070
OVR T2 3N 80-440s P TS QS	440	80	4	2CTB815708R3700	29,070

## Surge arrester for data line protection (Pluggable)



OVR SL

Description	Max. continuous operating voltage U <sub>c</sub> (V)	I max in kA (8/20us wave)	Width	Ordering code	L.P. (₹)
OVR SL06	7.79 V	10 kA	7mm	7TCA085400R0360	Upon request
OVR SL15	16.7 V	10 kA	7mm	7TCA085400R0361	
OVR SL30	36.7 V	10 kA	7mm	7TCA085400R0363	
OVR SL50	56.7 V	10 kA	7mm	7TCA085400R0364	
OVR SLTN	296 V	10 kA	7mm	7TCA085400R0323	

## DBT Timer digital time switches **NEW**

An ideal range for automating the functions of the installation

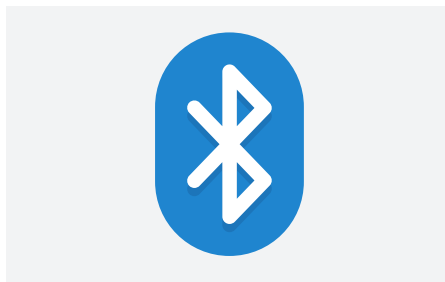
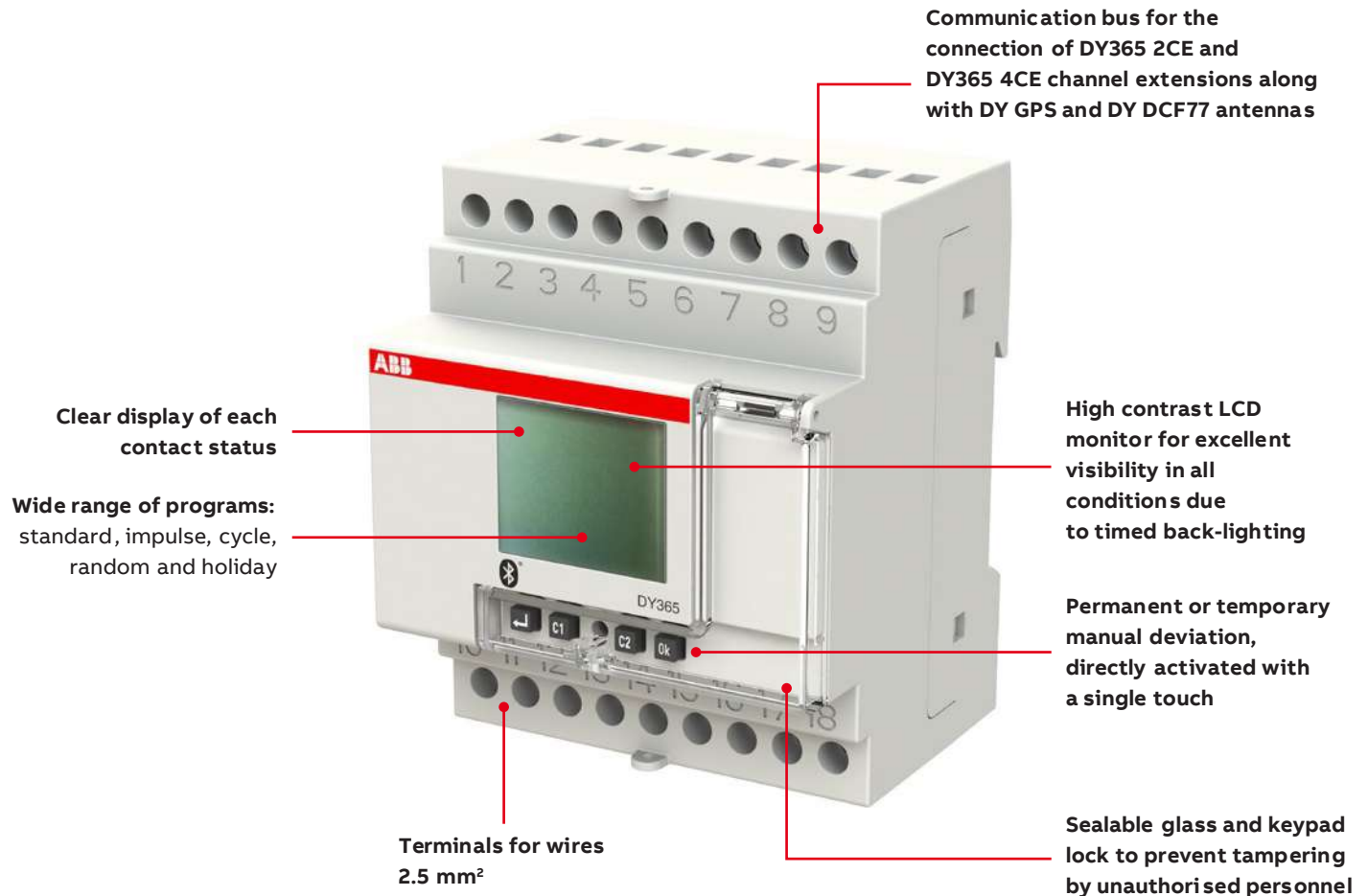

Wide range of programs: standard, impulse, cycle, random and holiday

- Permanent or temporary manual deviation, directly activated with a single touch
- LCD Display with back-lighting
- Up to 900 storable events
- Up to 400 pre-defined cities coordinates
- Accuracy of  $\pm 0.5$  seconds/24h
- Switching solar time/daylight saving time

Bluetooth communication combined with the DBT Timer APP available for Android and iOS ensure smart configuration and quick visualization. This functionality also allows to transfer programs from one device to another simply using the Smartphone.

Time synchronization via DY DCF77 or DY GPS antennas. The DY DCF77 antenna receives scheduled messages transmitted by the atomic clock installed c/o Mainflingen (Germany), near Frankfurt. Thanks to this signal, the time switches are automatically set to: hour, date and proper daylight saving time. The DY GPS antenna receives time from the Global Positioning System, providing an accurate location and time information for an unlimited number of people in all weathers, day or night, anywhere in the world.

# DBT Timer digital time switches

An ideal range for automating the functions of the installation



DW1

## Digital weekly time switch - DW

DW1 and DW2 are weekly digital time switches with 1 and 2 channels, respectively. They allow exclusion of the normal weekly program in every week with the same mode.

Description	Ordering code	L.P. (₹)
DW weekly digital time switches-DW1, 1 channel	2CSM222531R1000	11,850
DW weekly digital time switches-DW2, 2 channel	2CSM222521R1000	18,520



DWA1

## Digital weekly astronomical time switch - DWA

The astronomical switches DWA1 and DWA2, respectively, with 1 and 2 channels, automatically control lighting circuits depending on the time of sunrise and sunset, greatly increasing energy efficiency. The programming is in fact based on a mathematical algorithm able to calculate the time of the rising and setting of the sun in a certain location for each day of the year. Once powered the device, simply insert date, time, geographical coordinates and time zone so that it is ready to work. These settings can also be automatically defined using the DBT Timer APP. The installation of astronomical digital time switches is particularly useful when using a twilight switch with external sensor is not recommended because it may be subject to malfunctions caused by air pollution, excessive brightness or vandalism. DWA1 and DWA2 are also indicated for the control of public lighting, shop windows of shops, neon signs, monuments, facades, illuminated fountains.

Description	Ordering code	L.P. (₹)
DWA twilight astronomical switches DWA-1, 1 channel	2CSM222511R1000	25,670
DWA twilight astronomical switches DWA-2, 2 channel	2CSM222501R1000	32,040



TL1

TL1 Pole

## TL Line modular twilight switches

TL1 twilight switch allows to switch ON and switch OFF lighting devices according to a scheduled level of the ambient light. It is used in combination with an external sensor to detect if the ambient light is higher or lower than the set level. A switching delay prevents them from operating unnecessarily when the light intensity suddenly changes (e.g. lightning, moving vehicles, etc.). The TL1 twilight switch 1 channel is preset with a 10 LUX from factory and it is equipped with 2 signalling LEDs that indicate the setpoint value and display the status of the contact. The operating instructions are printed on the side of the product.

Description	Ordering code	L.P. (₹)
TL1 modular twilight switches 1 channel with external sensor TL1	2CSM229921R1341	10,570
TL1 pole twilight switches, installation on the pole/wall TL1 Pole	2CSM229911R1341	9,840



AD1CO-15m

## AG Timer electro-mechanical time switches

These analog timers are designed for installation on DIN-rail. They control circuit opening and closing according to the scheduled program. Available both on daily and weekly versions and equipped with a 16 A contact. They can be set on the scheduled program or on the permanent ON-OFF function. The AD1NO-R-15m, AD1CO-R-15m, AW1CO-R-120m, AD1CO-R-30m, AW1CO-R-210m versions are equipped with a built-in battery, charged by the network voltage, which allows the devices to maintain the set time also in case of long (up to 150 h) power supply failures. The products fit applications such as control of lighting systems of shops or commercial buildings, heating and ventilation systems as well as control of automatic irrigation systems of private or external gardens.

Description	Ordering code	L.P. (₹)
AD1CO Daily time switch, running reserve 1NO/1NC, AD1CO-R-15m	2CSM208151R1000 ■	5,190

## Control and automation components

Description	Ordering code	L.P. (₹)
E 232-230 staircase lighting time-delay switches, Staircase lighting time-delay switches are usually operated by pushbuttons, often fitted with a glow lamp. Switches are designed for a glow lamp current of up to 150 mA and thus perfectly suitable for installations in multi-storey buildings.	2CDE110000R0501	7,350
The E 232-230 staircase lighting time-delay switch includes an electro-mechanical timer with a synchronous motor drive to ensure high operational safety in whatever mounting position. The time range is adjustable in increments of 15 seconds from 1 to seven minutes. Resettable after 30 seconds	2CDE110003R0511	9,540



E200

■ Stock items

# SMISLINE TP plug-in system

Changes have never been easier

SMISLINE TP ensures that load-free devices and components can be snapped on and off under voltage without the need for additional personal protective equipment to guard against electrical hazards.

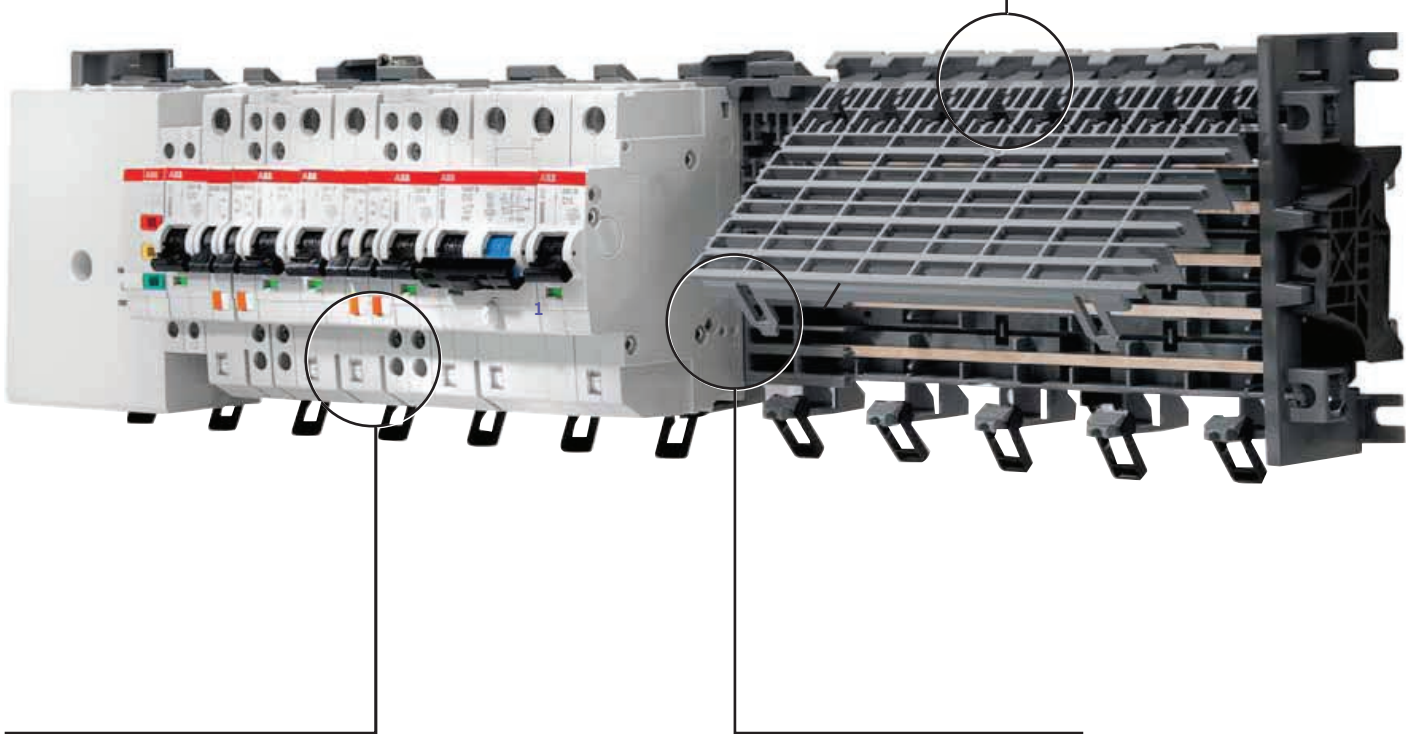

It opens up to completely new prospects for you when it comes to installation, operation and flexibility.

The world's first pluggable socket system.

# SMISLINE TP plug-in system

Changes have never been easier

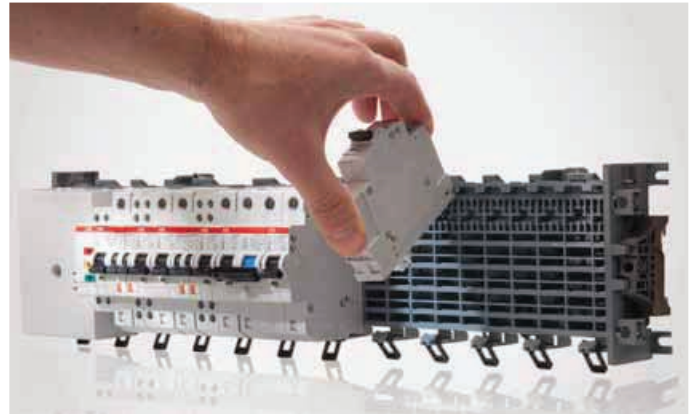
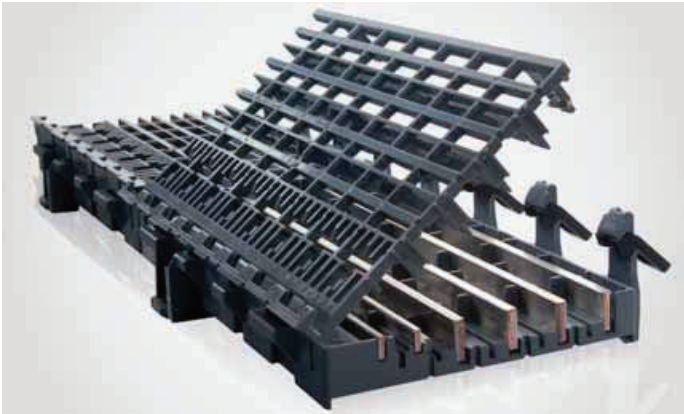

## Even safer: protection against electrical hazards

We have upgraded our unique SMISLINE socket system even further through the addition of a pioneering innovation. With the new SMISLINE TP system, components can now be plugged in or unplugged load-free without any risk from electrical current running through the body.

The SMISLINE TP pluggable socket system is completely fingersafe (IP2XB) – when devices are plugged in and unplugged, the system is always touch-proof. This means that SMISLINE TP prevents any danger to personnel from switching arcs or accidental arcing.

## Even more flexible: make additions and changes during on-going operation

Pluggable devices can be added and changed quickly, safely and simply during on-going operation. And this can be done without any need for personal protective equipment.

This means that you benefit from more flexibility, savings on installation and maintenance – and improved safety. SMISLINE TP provides greater availability and operating safety than conventional systems.

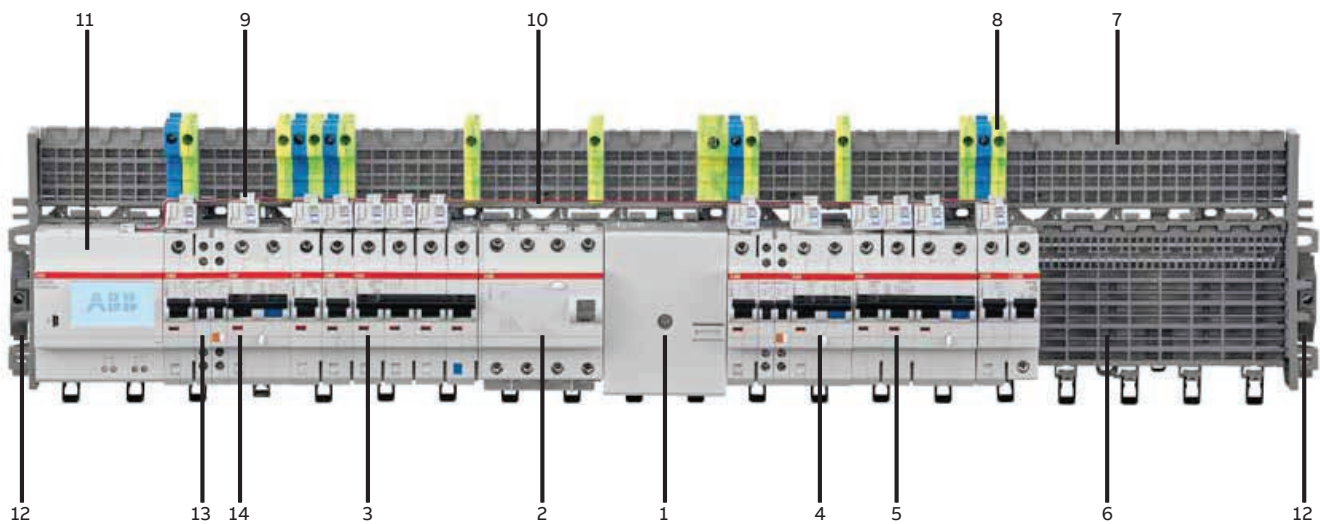

- |                                    |   |                      |
|------------------------------------|---|----------------------|
| 1 Supply terminal                  | 6 Socket IP20                           | 11 Control unit CMS  |
| 2 Surge arrester OVR404            | 7 Additional socket IP20                | 12 Socket end piece  |
| 3 Miniature circuit breaker S403NP | 8 Terminals                             | 13 Auxillary contact |
| 4 RCBO FS401                       | 9 Sensor for current measurement system | 14 Signal contact    |
| 5 RCBO FS403                       | 10 Cabel Bus system CMS                 |                      |

# ELR, Earth leakage relay - (DIN & front panel mountable)



Front panel residual current relays are electronic devices used in combination with an external toroidal transformer. They are according to the protection standard IEC/EN 60947-2 Annex-M. The sensitivity can be set from 0.03 A to 30 A, while the tripping time from 0 to 5 seconds. Residual current relays are available in versions 48x48 mm, 72x72 mm, and 96x96 mm. The Fail Safe function is available for versions ELR48P, ELR72P and ELR96P: the contacts switch when there is no auxiliary power.

The ELR96PF version is equipped with Fail Safe function, fault memory LED, and a frequency filter, that ensure continuity of service in the presence of harmonics.

ELR96PD has (in addition to these functions) a digital display for an instantaneous view of the residual current  $I_{\Delta n}$ .

Description	Operating voltage	Pack	Ordering code	L.P.(₹)
ELR48P	110 V a.c./d.c. - 230 V a.c.	1	2CSG252211R1202	
ELR48V24P	24-48 V a.c./d.c.	1	2CSG452211R1202	
ELR72	110 V a.c./d.c. - 230 V a.c.	1	2CSG252120R1202	
ELR72V24	24-48 V a.c./d.c.	1	2CSG452120R1202	
ELR72P	110-230-400 V a.c.	1	2CSG152424R1202	
ELR72V24P	24-48 V a.c./d.c.	1	2CSG452424R1202	Upon request
ELR96	110-230-400 V a.c.	1	2CSG152130R1202	
ELR96V24	24-48 V a.c./d.c.	1	2CSG452130R1202	
ELR96P	110-230-400 V a.c.	1	2CSG152434R1202	
ELR96V24P	24-48 V a.c./d.c.	1	2CSG452434R1202	
ELR96PF	110-230-400 V a.c.	1	2CSG152435R1202	
ELR96PD	110-230-400 V a.c.	1	2CSG152436R1202	

## RD3, residual current relays - (DIN rail mountable)

The RD3 family of electronic residual current relays provides residual current protection and monitoring functions according to IEC/EN 60947-2:2006 annex M and can be used in conjunction with all S 200 automatic devices and Tmax range moulded case devices up to T5, for industrial installations.

The RD3 residual current relays can provide status indications through two output contacts.

Description	Operating voltage	Pack	Ordering code	L.P.(₹)
RD3-48	12-48 a.c./d.c.	1	2CSJ201001R0001	
RD3	230-400 a.c.	1	2CSJ201001R0002	
RD3M-48	12-48 a.c./d.c.	1	2CSJ202001R0001	Upon request
RD3M	230-400 a.c.	1	2CSJ202001R0002	
RD3P-48	12-48 a.c./d.c.	1	2CSJ203001R0001	
RD3P	230-400 a.c.	1	2CSJ203001R0002	

## Toroidal transformers

Description	Toroid useful diameter (mm)	Min. measureable current (mA)	Max. rated current <sup>1</sup> (A)	Max. capacity <sup>2</sup> (A)	Pack	Ordering code	L.P.(₹)
TRM	29 (modular version)	30	65	160	1	2CSM029000R1211	
TR1	35	30	75	250	1	2CSG035100R1211	
TR2	60	30	85	400	1	2CSG060100R1211	
TR3	80	100	160	800	1	2CSG080100R1211	
TR4	110	100	250	1,250	1	2CSG110100R1211	
TR4/A	110 (openable version)	300	250	1,250	1	2CSG110200R1211	Upon request
TR160	160	300	400	2,000	1	2CSG160100R1211	
TR160A	160 (openable version)	500	400	2,000	1	2CSG160200R1211	
TR5	210	300	630	3,200	1	2CSG210100R1211	
TR5/A	210 (openable version)	500	630	3,200	1	2CSG210200R1211	

<sup>1</sup> Shows toroidal transformers selection for use with ELR according to IEC/EN 60947-2 Annex M in combination with MCBs S200 range and MCCBs Tmax range upto T5

<sup>2</sup> Shows the technical features of the toroidal transformers





# ABB Energy Efficiency Portfolio

## Metering solutions from basic to advanced

### Single function and Multi-function Metering solutions

ABB analog and digital single and multi-function instruments easily allow the monitoring of all the simplest electrical parameters.

### Basic Metering solutions

On top of the simplest measurements, ABB basic Multi-function meters also monitor Energy and Power. They are available with option for Modbus communication.

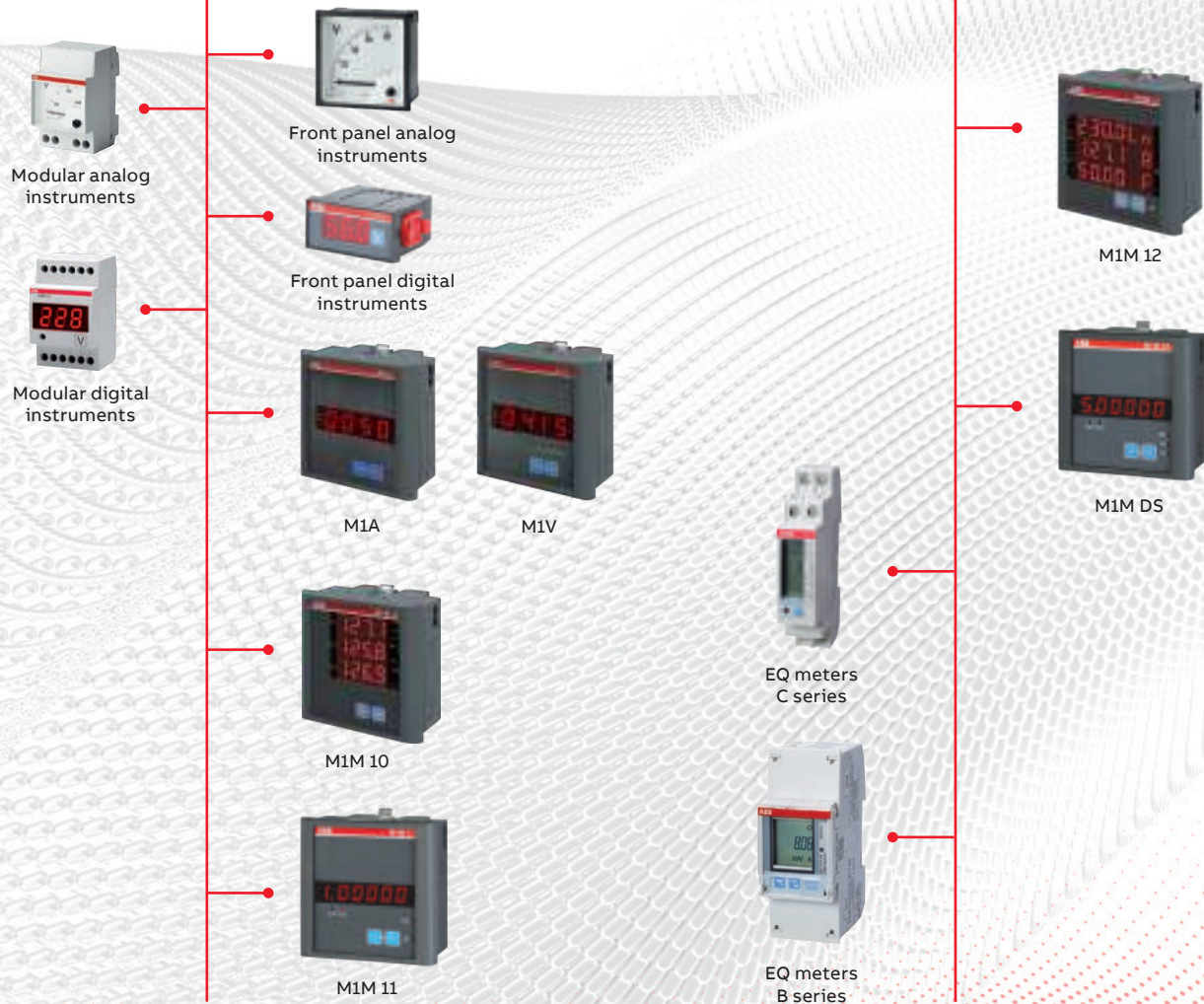



## Intermediate Metering solutions

Intermediate level solutions offer a wider range of measurements - including THD, Individual Harmonics and Unbalances - and functionalities - such as I/O, Timers, RTC and Alarms as optional choice.

## Advanced Metering solutions

M4M suits all power monitoring needs: from high-accuracy energy efficiency monitoring of electrical parameters to complete power quality analysis through advanced KPIs via cloud.



M1M 15



M4M 2X



M1M 20B



M1M 30B



M4M 20



EQ meters B series



M1M 20



M1M 30



M4M 30



EQ meters A series



CMS-700 Circuit Monitoring System



CMS-600/660 Circuit Monitoring System



SCU-100 InSite Pro



Digital I/O modules

# Measurement made simple

Making difference with M1M range of meters in sub-distribution switchboards.

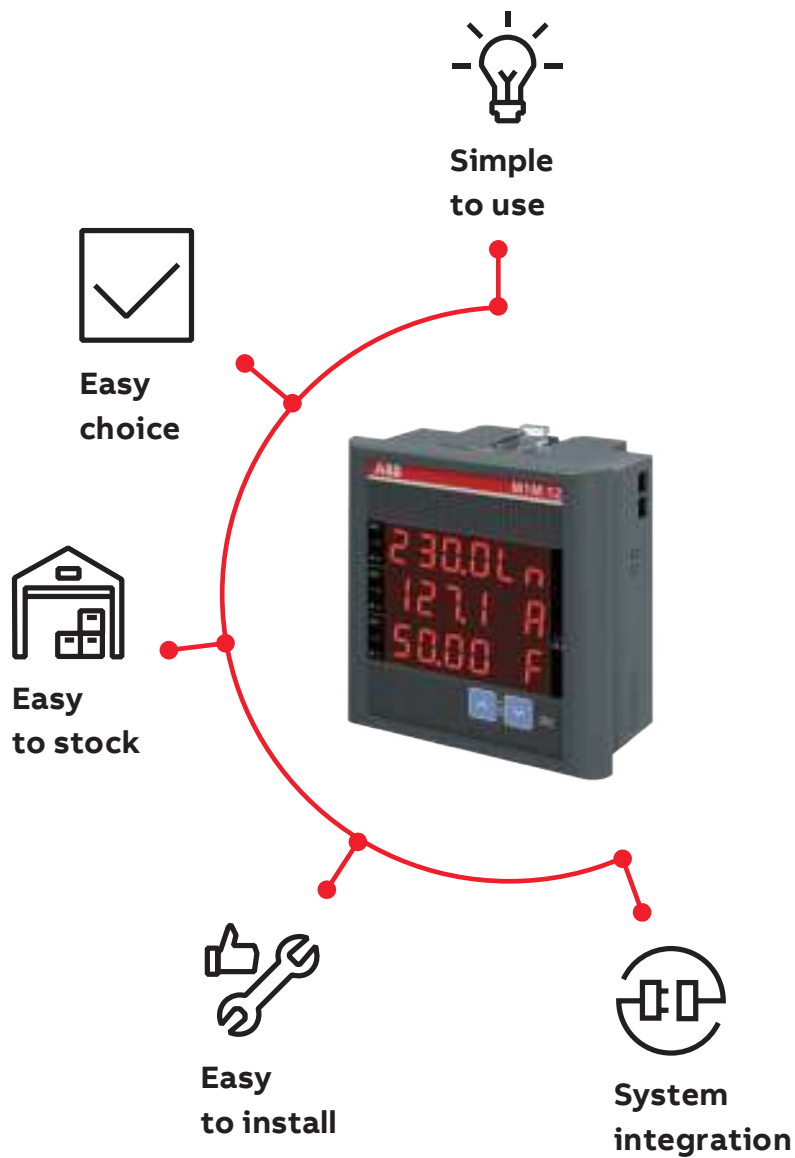

Commercial Buildings



Industrial Plants



Public Buildings

# Measurement made simple

## Value proposition

### Simple to use

- Intuitive visualization of the parameters on the bright LED display
- Enhanced clarity in data reading and device configuration

### Easy choice

- Maximum 2 steps to select the correct product for your application

### Easy to install and stock

- Compact product design and optimized volumetric weight of packaging
- No tools required for product mounting thanks to mounting clips

### System integration

- Remote monitoring in any Modbus RTU supervision system thanks to the optional RS485 port



M1M DS

## Your benefits



### For distributors

- Save space needed for internal stock
- Fast selection of the correct product for your orders
- Handle a minimum set of order codes



### For panel builders

- Reduce the time needed for meter installation on the panel
- Fast selection of the correct product for your application
- Increase the number of projects covered with the same product



# Technical features



Product type		Single Function and Multi-function meters M1M			
Product range		M1A 1-1 Ammeter	M1A 3-1 Ammeter	M1A 3-05 Ammeter	M1V 1-1 Voltmeter
Mounting		Front Panel	Front Panel	Front Panel	Front Panel
Standards	IEC 62053-21/22	#	#	#	#
	IEC 61557-12 PMD	-	-	-	-
	IEC 61000 4-2, 4-3, 4-4, 4-6, 4-8, 4-11	-	-	-	-
	IEC 61010-1	■	■	■	■
HMI	Display	LED	LED	LED	LED
	Accuracy Class	Class 1	Class 1	Class 0.5	Class 1
Measurement	Auxiliary Power Supply (80 - 300V AC/DC, L-N)	■	■	■	■
	Voltage measurement range	-	-	-	300V Max. AC (L-N)
	Current Measurement range	50mA - 6A	50mA - 6A	50mA - 6A	-
	Measurement via CT (.../1A or .../5A)	■	■	■	-
	Measurement via Rogowski coils	-	-	-	-
	Sample per cycle	32	32	32	32
Real-time	Current (I), Voltage (U, V), f	I	I	I	V
	Active Power (P), PF	-	-	-	-
	Reactive (Q), Apparent (S) Power	-	-	-	-
	Timers	-	-	-	-
Energy	Active energy	-	-	-	-
	Reactive, apparent energy	-	-	-	-
	4 quadrants energy (import/export)	-	-	-	-
Power Quality	THD	-	-	-	-
	Harmonics	-	-	-	-
	Unbalances	-	-	-	-
	Neutral current	-	-	-	-
Logging	Alarms	-	-	-	-
	Complex alarms with logics	-	-	-	-
	Min/max/demand	-	-	-	-
	Flash memory	-	-	-	-
	RTC	-	-	-	-
HMI	Graphs visualization	-	-	-	-
	Homepage and favourite page	-	-	-	-
	Password protection	■	■	■	■
	Standard I/O	-	-	-	-
	Additional I/O	-	-	-	-
	M-bus	-	-	-	-
	Modbus RTU	-	-	-	-
	Modbus TCP/IP	-	-	-	-
	Profibus DP-V0	-	-	-	-
	BACnet/IP	-	-	-	-
Communication	Bluetooth	-	-	-	-
	Automatic integration in System pro M compact® InSite	-	-	-	-
	Automatic integration in ABB Ability™ Energy and Asset Manager	-	-	-	-
	InSite-bus flat cable	-	-	-	-

\* Available starting from 2022 Q2. # Calibration document included in the product packaging.



<b>M1V 3-1- Voltmeter</b>	<b>M1V 3-05 Voltmeter</b>	<b>M1M 11-1 kWh</b>	<b>M1M 11-05 kWh</b>	<b>M1M 10</b>	<b>M1M 12</b>	<b>M1M DS Dual source</b>
Front Panel	Front Panel	Front panel	Front panel	Front panel	Front panel	Front panel
#	#	#	#	#	#	#
-	-	-	-	-	-	-
-	-	-	-	-	-	-
■	■	■	■	■	■	■
LED	LED	LED	LED	LED	LED	LED
Class 1	Class 0.5	Class 1	Class 0.5	Class 1	Class 1	Class 0.5
■	■	■	■	■	■	■
300V Max. AC (L-N) 80-515V AC (L-L)	300V Max. AC (L-N) 80-515V AC (L-L)	300V Max. AC (L-N) 80-515V AC (L-L)	300V Max. AC (L-N) 80-515V AC (L-L)	300V Max. AC (L-N) 80-515V AC (L-L)	300V Max. AC (L-N) 80-515V AC (L-L)	300V Max. AC (L-N) 80-515V AC (L-L)
-	-	50mA - 6A	50mA - 6A	50mA - 6A	50mA - 6A	50mA - 6A
-	-	■	■	■	■	■
-	-	-	-	-	-	-
32	32	64	64	64	64	64
V, f	V, f	-	-	■	■	■
-	-	-	-	-	■	■
-	-	Apparent	Apparent	-	-	Apparent
-	-	-	-	-	-	-
-	-	■	■	-	■	■
-	-	Apparent	Apparent	-	-	Apparent
-	-	-	-	-	-	-
-	-	-	-	-	-	-
-	-	-	-	-	-	-
-	-	-	-	-	-	-
-	-	-	-	-	-	-
-	-	-	-	-	-	-
-	-	-	-	-	-	-
-	-	-	-	-	-	-
-	-	-	-	-	-	-
-	-	-	-	-	-	-
■	■	■	■	■	■	■
-	-	-	-	-	-	-
-	-	-	-	-	-	-
-	-	-	-	-	-	-
-	-	■	■	-	■	■
-	-	-	-	-	-	-
-	-	-	-	-	-	-
-	-	-	-	-	-	-
-	-	-	-	-	-	-
-	-	*	*	-	*	*
-	-	*	*	-	*	*
-	-	-	-	-	-	-

# M1 Single Function Measurement Devices

## M1A, M1V and M1M 11

### Ordering codes



M1A

#### M1A

M1A is a digital ammeter for Current measurement, providing the measurement of the single-phase or three-phase Current and allowing easy replacement of different analog meters.

Accuracy Class	Communication protocol and interface	Order details Type code	Order code	Weight 1 piece kg	Pack unit pc.	L.P. (₹)
Class 1	-	M1A 1-1 Ammeter 1Ph	1SYG235145R4051 ■	0.19	1	1,720
Class 1	-	M1A 3-1 Ammeter 3Ph	1SYG235135R4051 ■	0.19	1	2,630
Class 0.5	-	M1A 3-05 Ammeter 3Ph	1SYG234905R4051 ■	0.19	1	3,100



M1V

#### M1V

M1V is a digital voltmeter for Voltage (and Frequency) measurement, providing the measurement of the single-phase or three-phase Voltage as well as Frequency (for 3Ph Voltmeter) and allowing easy replacement of different analogue meters.

Accuracy Class	Communication protocol and interface	Order details Type code	Order code	Weight 1 piece kg	Pack unit pc.	L.P. (₹)
Class 1	-	M1V 1-1 Volt Meter 1Ph	1SYG233965R4051 ■	0.19	1	1,720
Class 1	-	M1V 3-1 Volt Meter 3Ph	1SYG233955R4051 ■	0.19	1	2,630
Class 0.5	-	M1V 3-05 Volt Meter 3Ph	1SYG233695R4051 ■	0.19	1	3,100

#### M1M 11

M1M 11 is a digital kWh meter for energy measurement, providing the measurement of the single-phase and three-phase energy consumption.



M1M 11

Accuracy Class	Communication protocol and interface	Order details Type code	Order code	Weight 1 piece kg	Pack unit pc.	L.P. (₹)
Class 1	Modbus RTU RS485	M1M 11-1 kWh Meter Modbus	1SYG233685R4051 ■	0.22	1	8,760
Class 0.5	Modbus RTU RS485	M1M 11-05 kWh Meter Modbus	1SYG232395R4051 ■	0.22	1	8,870

# M1 Multi-function Measurement Devices

## M1M 10, M1M 12 and M1M DS

### Ordering codes



M1M 10

#### M1M 10

M1M 10 is a VAF meter for basic electrical system monitoring, providing the measurement of the main single-phase and three-phase electrical parameters and allowing easy replacement of different analogue meters.

Accuracy Class	Communication protocol and interface	Order details Type code	Order code	Weight 1 piece kg	Pack unit pc.	L.P. (₹)
Class 1	-	M1M 10-1	1SYG235081R4051 ■	0.3	1	3,060



M1M 12

#### M1M 12

M1M 12 is a Multi-function meter, providing what is needed to monitor the electrical system and allowing statistical metering of active energy consumption.

M1M 12 product range includes option with built-in communication protocol (Modbus RTU) through RS485 communication port, allowing easy integration with Modbus supervision systems.

Accuracy Class	Communication protocol and interface	Order details Type code	Order code	Weight 1 piece kg	Pack unit pc.	L.P. (₹)
Class 1	-	M1M 12-1	1SYG207591R4051 ■	0.3	1	9,880
Class 1	Modbus RTU RS485	M1M 12-1 Modbus	1SYG207581R4051 ■	0.3	1	10,940



M1M DS

#### M1M DS

M1M DS is a digital dual source meter for the measurement of basic electrical parameters along with power parameters for two source measurement such as EB/DG.

Accuracy Class	Communication protocol and interface	Order details Type code	Order code	Weight 1 piece kg	Pack unit pc.	L.P. (₹)
Class 0.5	-	M1M DS-05	1SYG232385R4051 ■	0.21	1	8,480
Class 0.5	Modbus RTU RS485	M1M DS-05 Modbus	1SYG232375R4051 ■	0.21	1	8,750

# M1M Power Meters

Introducing the new ABB power meters ranges M1M 15, M1M 20B, M1M 30B, M1M 20 and M1M 30 an easy solution for any standard application in buildings and industry.

M1M 15, M1M 20B, M1M 30B, M1M 20 and M1M 30 are the new ABB ranges of power meters, offering exactly what is needed to monitor the electrical system and analyze the power quality in a single device.

The new M1M power meters offer allows to easily and cost-effectively cover the main submetering and power quality monitoring requirements in commercial and industrial buildings, either small or mid/large-sized, e.g. inside power factor correction boards, motor control center or sub-distribution switchboards.

ABB's complete multifunction meters product line, now including M1M 15, M1M 20B, M1M 30B, M1M 20

and M1M 30 ranges, are capable to cover all needs, from basic electrical parameters measurement to advanced power quality analysis.

ABB's power meters are simple to use, with a common and intuitive user experience from installation to operations, allowing to fully exploit the reliable, IEC-compliant measurements.

Thanks to their connectivity capabilities, M1M can get leverage on the integration in ABB scalable energy and asset management solutions to monitor, optimize and control the complete electrical system, such as System pro M compact® InSite and ABB Ability™ Energy and Asset Manager cloud-computing platform.



Commercial Buildings



Industrial Plants



Public Buildings



M1M 15



M1M 20B



M1M 30B



M1M 20



M1M 30



# Measurement made simple

The complete M1M range, offering all the measurement features required for basic power quality monitoring and submetering in a single power meter; making measurement simple.



—  
Complete offer

### ABB meters to cover all needs

Select in maximum 2 steps the right and most competitive power meter to cover all basic electrical system measurement needs. Thanks to integrated functionalities and communication protocols, the same product version fits an increased number of projects and wide applications range.



—  
Easy to use

### Common user experience

Common and intuitive menu structure all over the different ranges on clear and large backlit LCD/LED displays, helping to reduce the time needed to operate the power meters. Feedback on correct operations and quick reactivity on the system events are ensured by alarms icons and frontal LEDs on all product versions.



—  
Easy to install

### Optimized installation process

Compact power meters, ensuring a very limited footprint inside the panel, provide a common, vertical disposition of the terminals for easy wiring of cables directly from the sides. No special tool is required for product mounting thanks to mounting clips.



—  
Energy Efficiency

### Reliable and accurate measurement

Complete set of measurement functionalities, from Multi-function meters to intermediate power meters, compliant with accuracy standard IEC 61557-12 to allow improving energy efficiency of the electrical system. Remote communication on main communication protocol, Modbus RTU and Modbus TCP/IP.

## — Your benefits

### For distributors

- Reduce selection time of the correct product thanks to reduced range complexity
- Manage a limited number of order codes from a single supplier
- Save space needed for internal stock
- Have the product on stock when needed and reduce delivery time

### For panel builders

- 1 supplier only for all measurement products covering wide range of projects
- Increase competitiveness in projects
- Reduce time needed for product selection thanks to simple range composition
- Reduce time for installation and operations
- Minimum space requirements in the panel

# Technical features



Product type		Power meters M1M		
Product range		M1M 15	M1M 20B-1	M1M 20B-05
Mounting		Front panel	Front panel	Front panel
Standards	IEC 62053-21/22	■	■	■
	IEC 61557-12 PMD	■	-	-
	IEC 61000 4-2, 4-3, 4-4, 4-6, 4-8, 4-11	■	■	■
	IEC 61010-1	■	■	■
HMI	Display	LED	LED	LED
	Accuracy Class	Class 1	Class 1	Class 0.5
Measurement	Auxiliary Power Supply (L-N)	100-230 V AC/DC ±15%	80-300V AC/DC	80-300V AC/DC
	Current Measurement range	50mA - 6A	50mA - 6A	50mA - 6A
	Voltage measurement range	80-265 VAC (L-N) 138-458 VAC (L-L)	300V Max. AC (L-N) 80-515V AC (L-L)	300V Max. AC (L-N) 80-515V AC (L-L)
	Measurement via CT (.../1A or .../5A)	■	■	■
	Measurement via Rogowski coils	-	-	-
	Sample per cycle	128	128	128
Real-time	Current (I), Voltage (U, V), f	■	■	■
	Active Power (P), PF	■	■	■
	Reactive (Q), Apparent (S) Power	■	■	■
	Timers	■	-	-
Energy	Active energy	■	■	■
	Reactive, Apparent energy	■	■	■
	4 quadrants energy (import/export)	-	Delivered, Received	Delivered, Received
	Multi-tariffs	-	-	-
Power Quality	THD	-	■	■
	Individual Harmonics	-	-	-
	Unbalances	-	■	■
	Neutral current	-	Calculated	Calculated
	Phasors, waveforms	-	-	-
Logging	Alarms	-	-	-
	Complex alarms with logics	-	-	-
	Min/max/demand	-	■	■
	Flash memory	-	-	-
	RTC	-	-	-
HMI	Graphs visualization	-	-	-
	Homepage and favourite page	-	-	-
Communication	Password protection	■	■	■
	Standard I/O	-	-	-
	Additional I/O	-	-	-
	M-bus	-	-	-
	Modbus RTU	■	■	■
	Modbus TCP/IP	-	-	-
	Profibus DP-V0	-	-	-
	BACnet/IP	-	-	-
	Bluetooth	-	-	-
	Automatic integration in System pro M compact® InSite	*	*	*
Automatic integration in ABB Ability™ Energy and Asset Manager	*	*	*	
InSite-bus flat cable	-	-	-	

\* Available starting from 2022 Q2



M1M 20B-02	M1M 30B-05	M1M 30B-02	M1M 20	M1M 30
Front panel	Front panel	Front panel	Front panel	Front panel
■	■	■	■	■
-	-	-	■	■
■	■	■	■	■
■	■	■	■	■
LED	LED	LED	LCD	LCD
Class 0.2	Class 0.5	Class 0.2	Class 1/Class 0.5 (IO Version)	Class 1/Class 0.5 (IO Version)
80-300V AC/DC	80-300V AC/DC	80-300V AC/DC	100-230 V AC/DC ±15%	100-230 V AC/DC ±15%
50mA - 6A	50mA - 6A	50mA - 6A	50mA - 6A	50mA - 6A
300V Max. AC (L-N) 80-515V AC (L-L)	300V Max. AC (L-N) 80-515V AC (L-L)	300V Max. AC (L-N) 80-515V AC (L-L)	80-265 VAC (L-N) 138-458 VAC (L-L)	80-265 VAC (L-N) 138-458 VAC (L-L)
■	■	■	■	■
-	-	-	-	-
128	128	128	128	128
■	■	■	■	■
■	■	■	■	■
■	■	■	■	■
-	■	■	■	■
■	■	■	■	■
■	■	■	■	■
Delivered, Received	Delivered, Received, Total, Net, Last cleared	Delivered, Received, Total, Net, Last cleared	■	■
-	-	-	-	-
■	■	■	■	■
-	31st	31st	-	40th
■	■	■	-	■
Calculated	Calculated	Calculated	Calculated	Calculated
-	-	-	-	-
-	-	-	15	15
-	-	-	-	-
■	■	■	-	Basic
-	-	-	-	■
-	■	■	-	■
-	-	-	-	-
-	-	-	-	-
■	■	■	■	■
-	-	-	-	2 Digital Outputs
-	-	-	2 Digital Inputs. 2 Digital Outputs	2 Digital Inputs. 2 Digital Outputs
-	-	-	-	-
■	■	■	■	■
-	-	-	■	■
-	-	-	-	-
-	-	-	-	-
-	-	-	-	-
*	*	*	■	■
*	*	*	■	■
-	-	-	-	-

# M1M Power Meters

## M1M 15, M1M 20B, M1M 30B, M1M 20 and M1M 30

### Ordering codes



M1M 15

#### M1M 15

M1M 15 is a complete multifunction meter for electrical system monitoring, mainly targeting measurement of basic electrical parameters and applications for cost allocation of energy consumptions.

Accuracy Class	Communication Protocol	I/O	Order details Type code	Order code	Weight 1 piece kg	Pack unit pc.	L.P. (₹)
Class 1	-	-	M1M 15-1	2TAZ661010R2000	0.31	1	24,040
Class 1	Modbus RTU	-	M1M 15-1 Modbus	2TAZ661012R2000	0.31	1	25,820



M1M 20B

#### M1M 20B

M1M 20B is a power meter including THD and import/export (4 quadrants) measurement for basic power quality analysis applications such as power factor management and local energy generation monitoring.

Accuracy Class	Communication protocol and interface	I/O	Order details Type code	Order code	Weight 1 piece kg	Pack unit pc.	L.P. (₹)
Class 1	Modbus RTU RS485	-	M1M 20B-1 Modbus	1SYG231445R4051 ■	0.26	1	19,500
Class 0.5	Modbus RTU RS485	-	M1M 20B-05 Modbus	1SYG230355R4051	0.26	1	24,800
Class 0.2	Modbus RTU RS485	-	M1M 20B-02 Modbus	1SYG230295R4051	0.26	1	30,950



M1M 30B

#### M1M 30B

M1M 30B is a power meter providing complete features in terms of power quality analysis such as measurement up to 31st harmonic allowing to target demand management applications.

Accuracy Class	Communication protocol and interface	I/O	Order details Type code	Order code	Weight 1 piece kg	Pack unit pc.	L.P. (₹)
Class 0.5	Modbus RTU RS485	-	M1M 30B-05 Modbus	1SYG230185R4051 ■	0.27	1	30,210
Class 0.2	Modbus RTU RS485	-	M1M 30B-02 Modbus	1SYG229775R4051	0.27	1	33,920



M1M 20

#### M1M 20

M1M 20 is a power meter including THD and import/export (4 quadrants) measurement for basic power quality analysis applications such as power factor management and local energy generation monitoring.

Accuracy Class	Communication Protocol	I/O	Order details Type code	Order code	Weight 1 piece kg	Pack unit pc.	L.P. (₹)
Class 1	-	-	M1M 20-1	2TAZ662010R2000	0.31	1	33,160
Class 1	Modbus RTU	-	M1M 20-1 Modbus	2TAZ662012R2000	0.32	1	36,840
Class 1	Modbus TCP/IP	-	M1M 20-1 Ethernet	2TAZ662014R2000	0.33	1	44,210
Class 0.5	Modbus RTU	2 Digital Out. 2 Digital In.	M1M 20-05 I/O	2TAZ662012R2001	0.33	1	46,050



M1M 30

#### M1M 30

M1M 30 is a power meter providing complete features in terms of power quality analysis such as measurement up to 40th harmonic and internal memory for datalogging, allowing to target e.g. demand management applications.

Accuracy Class	Communication Protocol	I/O	Order details Type code	Order code	Weight 1 piece kg	Pack unit pc.	L.P. (₹)
Class 1	Modbus RTU	2 Digital Out.	M1M 30-1 Modbus	2TAZ663012R2000	0.32	1	46,880
Class 1	Modbus TCP/IP	2 Digital Out.	M1M 30-1 Ethernet	2TAZ663014R2000	0.34	1	56,260
Class 0.5	Modbus RTU	2 Digital Out. 2 Digital In.	M1M 30-05 I/O	2TAZ663012R2001	0.33	1	58,610

■ Stock items



---

# M4M Network Analyzers

## Discover the benefits

M4M as a stand-alone network analyzer guarantees all power monitoring needs in the energy distribution system: from high-accuracy energy efficiency monitoring of electrical parameters to complete power quality analysis. Thanks to its connectivity capabilities, M4M can get leverage on the integration in ABB scalable energy and asset management solutions. Thanks to MID certification, M4M allows now to fulfil all legal requirements for accounting and energy acquisition.



—  
-50% Time for integration  
in the ABB turnkey solution

### Full connectivity

Natively integrated in sub-distribution management System pro M compact® InSite and ABB Ability™ Energy and Asset Manager cloud-solution, M4M benefits from the scalability of the ABB digital solutions: from stand-alone visualization and commissioning to monitoring, optimization and control of the complete electrical system.



—  
Reliable and accurate power  
monitoring

### Energy Efficiency

ABB's M4M range of network analyzers gathers data from the electrical system and provides a complete power quality analysis and high accuracy energy monitoring. MID certification available to ensure certified and tamper-proof measurement for billing applications and fulfilment of legal requirements for accounting and energy acquisition.



—  
-40% Time for installation  
and commissioning

### Simple and Intuitive

M4M makes configuration and operations simple and fast, from easy installation and wiring thanks to compact dimensions, all-removable terminals and Rogowski coils, to intuitive use and data access thanks to touchscreen color display, mobile APP and desktop software.



—  
Improve reactivity and reduce  
uncoordinated maintenance

### Realtime supervision

M4M network analyzers make information easy to access from any area of the system, providing a comprehensive range of accurate data and notifications that enhance reactivity to the events on the electrical system and allowing to avoid overloads, outages and uncoordinated maintenance.



# Explore the M4M ranges

M4M network analyzers are available in different versions which ensure all power monitoring needs, from basic to more complete power quality analysis.



EQUIPPED WITH GRAPHIC COLOR DISPLAY AND 5 PUSHBUTTONS KEYBOARD, M4M 20 RANGE ALLOWS COMPLETE MONITORING AND BASIC POWER QUALITY ANALYSIS.



EQUIPPED WITH TOUCHSCREEN COLOR DISPLAY, M4M 30 RANGE ALLOWS COMPLETE POWER QUALITY ANALYSIS AND ENERGY EFFICIENCY EVALUATIONS.



M4M 2X ON DIN-RAIL WITHOUT DISPLAY, ENSURING HIGH FLEXIBILITY TO PROJECT SPECIFICATIONS COMPARED TO STANDARD NETWORK ANALYZERS.

## MID-certification

Availability of MID approval to ensure certified and tamper-proof measurement for billing applications.

## Graphic color display

M4M 20 and M4M 30 are equipped with a graphic color display and common app-based menu for an intuitive visualization.

## Bluetooth-enabled

All M4M network analyzers are equipped with Bluetooth module for smart commissioning via mobile app.

## Full communication

A complete set of embedded communication protocols, including Modbus RTU, Modbus TCP/IP, Profibus DP-V0 and BACnet/IP

## Input/Output

Control on the system thanks to I/O options including digital outputs, programmable I/O or programmable analogue outputs.

## Datalogger

Data logging features are available, from complete notification logs to flash memory and RTC for 1-year data logging of trends.

## Rogowski version

M4M Rogowski versions are compatible with ABB's R4M Rogowski coils for easy retrofit in existing installations.



01

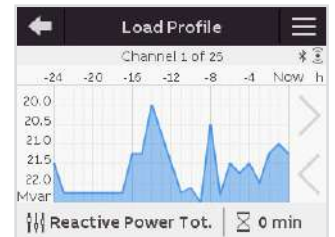

02



03



04

01 M4M Homepage

02 Trending graphs of load profiles

03 R4M Rogowski coils

04 M4M with MID certification



# Access to M4M network analyzers

M4M network analyzers offer the strongest scalability to access the measurement data, from color graphic display to smartphone app and desktop software, up to webserver and cloud-platform when integrated in the ABB digital solutions.

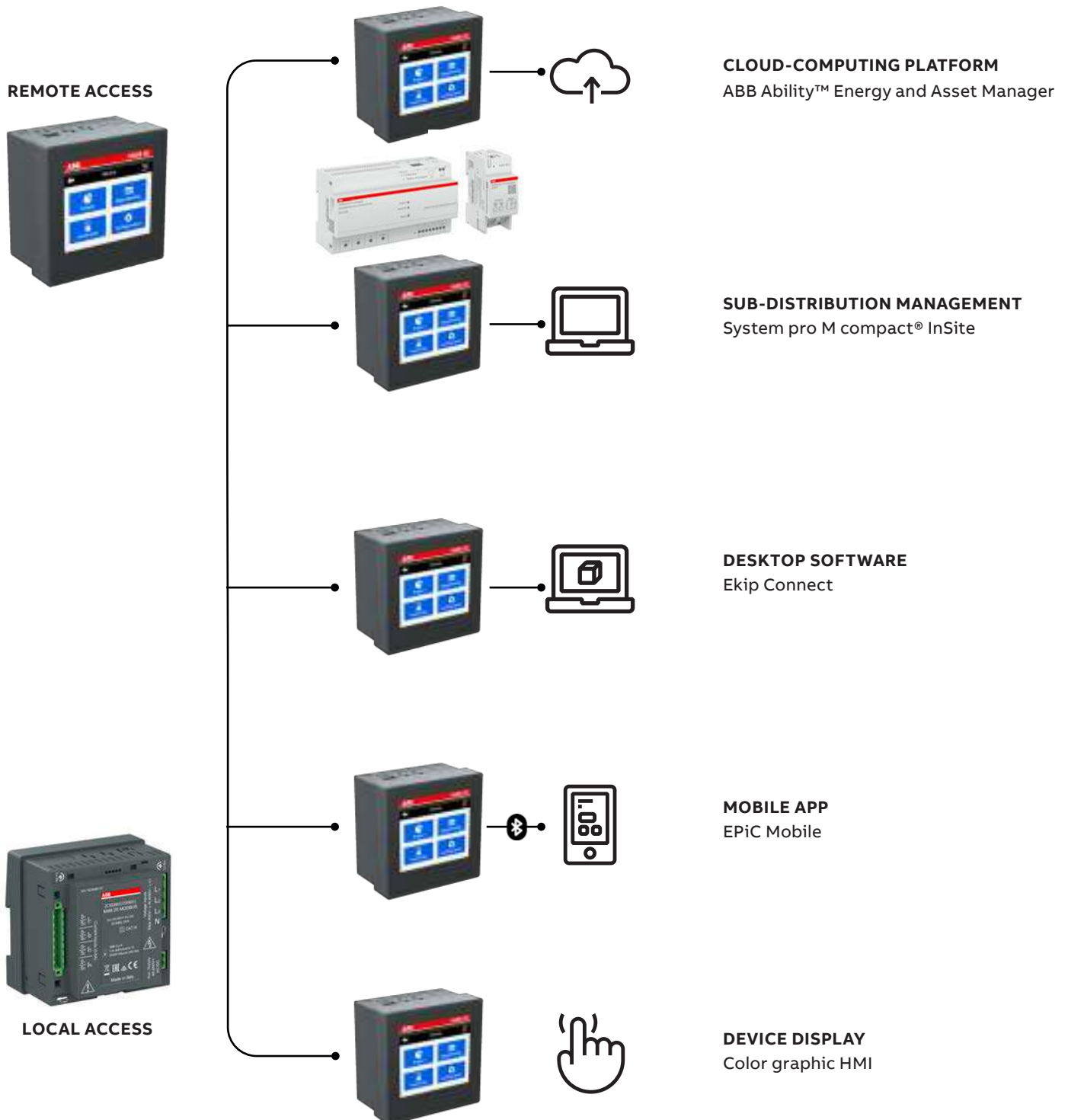

# Technical features



M4M 20



M4M 30



M4M 2X

## Mechanical characteristics

Overall dimensions	96 mm x 96 mm x 77 mm (Depth inside the switchboard: 57 mm)	96 mm x 96 mm x 77 mm (DIN-rail mounting)
IP degree of protection (acc. to IEC 60529)	Front: IP54	-
Weight [g]	Terminals: IP20 400	

## Terminal characteristics

Voltage inputs	Nominal cross section: 2,5 mm <sup>2</sup> Solid/stranded wire: 0,2 - 2,5 mm <sup>2</sup> (AWG 24 - 12) Pitch: 7,62 mm Poles: 4		
Current inputs	Nominal cross section: 2,5 mm <sup>2</sup> Solid/stranded wire: 0,2 - 2,5 mm <sup>2</sup> (AWG 24 - 12) Pitch: 5,08 mm Poles: 6 Screw flanges for fixing	Nominal cross section: 2,5 mm <sup>2</sup> Solid/stranded wire: 0,2 - 2,5 mm <sup>2</sup> (AWG 24 - 12) Pitch: 5,08 mm Poles: 8 Screw flanges for fixing	
RS-485 Serial port	Nominal cross section: 2,5 mm <sup>2</sup> Solid/stranded wire: 0,2 - 2,5 mm <sup>2</sup> (AWG 24 - 12) Pitch: 5,08 mm Poles: 3		
I/O	Nominal cross section: 2,5 mm <sup>2</sup> Solid/stranded wire: 0,2 - 2,5 mm <sup>2</sup> (AWG 24 - 12) Pitch: 5,08 mm Poles: 3 (Programmable I/O, only on M4M 20 I/O) Poles: 3 (Digital outputs) Poles: 3 (Analogue outputs, only on M4M 20 I/O)	Nominal cross section: 2,5 mm <sup>2</sup> Solid/stranded wire: 0,2 - 2,5 mm <sup>2</sup> (AWG 24 - 12) Pitch: 5,08 mm Poles: 5 (Programmable I/O) Poles: 3 (Programmable I/O only on M4M 30 I/O) Poles: 3 (Analogue outputs, only on M4M 30 I/O)	Nominal cross section: 2,5 mm <sup>2</sup> Solid/stranded wire: 0,2 - 2,5 mm <sup>2</sup> (AWG 24 - 12) Pitch: 5,08 mm Poles: 5 (Programmable I/O)
Rogowski current probes	Only with ABB Rogowski probes: - R4M-200 2CSG202150R1101 (200 mm diameter) - R4M-80 2CSG202160R1101 (80 mm diameter)		

## Climatic conditions

Operating temperature	-25 to 70 °C (K70 acc. to IEC 61557-12)
Storage temperature	-40 to 85 °C (K70 acc. to IEC 61557-12)
Relative humidity	Max 93 % (non-condensing) at 40 °C
Pollution degree	2
Altitude	< 2.000 m

## User Interface

Access to device	5 pushbuttons	Touchscreen	-
Display type	Graphic color display		-
Display dimensions	70 x 52 mm (3.5")		-



M4M 20



M4M 30



M4M 2X

<b>Communication protocol</b>			
<b>Modbus RTU</b>	M4M 20 Modbus, M4M 20 I/O, M4M 20 Rogowski, M4M 20-M Modbus	M4M 30 Modbus, M4M 30 I/O, M4M 30 Rogowski, M4M 30-M Modbus	M4M 2X Modbus
Communication interface	RS485 with optical isolation		
Baud rate	9600, 19200, 38400, 57600, 115200 bps		
Parity number	Odd, Even, None		
Stop bit	1, 2		
Address	1-247		
Connector	3 pole terminal		
<b>Profibus DP-V0</b>	<b>M4M 20 Profibus</b>	<b>M4M 30 Profibus</b>	-
Protocol	Profibus with slave DP-V0 function in compliance with IEC 61158 regulations		
Communication interface	RS485 with optical isolation		
Baud rate	Automatic detection [9,6 kpbs - 12 Mbps]		
Address	0-126		
Connector	DB 9 female connector (do not use connectors with 90° cable outlet)		
LED indicators	Green for communication status Red for communication error		
<b>Modbus TCP/IP</b>	<b>M4M 20 Ethernet, M4M 20-M Ethernet</b>	<b>M4M 30 Ethernet, M4M 30-M Ethernet</b>	<b>M4M 2X Ethernet</b>
Protocol	Modbus TCP/IP		
Communication interface	RJ45 RJ45 (2 ports for daisy-chain)*		
<b>BACnet</b>	<b>M4M 20 Bacnet</b>	<b>M4M 30 Bacnet</b>	-
Protocol	BACnet/IP		
Communication interface	RJ45		
<b>Bluetooth</b>			
Type	BLE (Bluetooth Low Energy)		
<b>Real-time clock</b>			
	Available on 2X PQ1, 2X PQ2, 2X RTS		
Clock drift	-	~ 0,4 seconds per day	
Battery backup time	-	~ 3 days without aux supply	
<b>Standards</b>			
Power metering and monitoring devices (PMD)	IEC 61557-12 (IEC 62053-22, IEC 62053-23)		
Electrical safety	IEC 61010-1		
EMC	IEC 61326-1 (IEC 61000-3-2, IEC 61000-3-3, IEC 61000-4-2, IEC 61000-4-3, IEC 61000-4-4, IEC 61000-4-5, IEC 61000-4-6, IEC 61000-4-8, IEC 61000-4-11)		

\* 1x RJ45 port available on M4M 30-M

# M4M 20 and M4M 30

## Comparing the two versions



	M4M 20 - Class 0,5S	M4M 30 - Class 0,5S
<b>Accuracy</b>		
<b>MID approval</b>	Optional	Optional
<b>Real-time</b>		
TRMS current	•	•
TRMS voltage	•	•
Frequency	•	•
Active, Reactive and Apparent power	•	•
Power factor	•	•
Operating timer, countdown timer	•	•
<b>Energy</b>		
Active, Reactive and Apparent energy	•	•
4 quadrants Energy (Import/Export)	•	•
Tariffs	/	•
<b>Power Quality</b>		
THD (I, VLN, VLL)	•	•
Individual Harmonics	/	40 <sup>th</sup>
Unbalances (I, VLN, VLL)	/	•
Neutral current	Calculated	Measured
Phasors (I, VLN)	/	•
Waveforms (I, VLN, VLL)	/	•
<b>Data recording and logs</b>		
Single alarms	25	25
Warnings, alarms and errors logs	•	•
Complex alarms with logics	/	4
Demand values (average)	Basic	Advanced
Min/Max Demand values	Basic	Advanced
Energy Trending logs	/	•
RTC	/	•
<b>HMI</b>	<b>Graphic color</b>	<b>Graphic color touchscreen</b>
Graphs visualization	Basic	Advanced
Notifications	•	•
Homepage and favourite page	•	•
Password protection	•	•
<b>Connectivity</b>		
Automatic integration in ABB Ability™ Energy and Asset Manager	•	•
Automatic integration in System pro M compact InSite	•	•
Bluetooth Low Energy	•	•
Communication Protocols	Modbus RTU, Modbus TCP/IP, Profibus DP-V0, BACnet/IP	Modbus RTU, Modbus TCP/IP, Profibus DP-V0, BACnet/IP
RJ45 Daisy Chain (Ethernet version)	/	•*

\* daisy chain not available on M4M 30-M

# M4M 2X

## Functionality packages



### Accuracy

### M4M 2X - Class 0,5S

TRMS current	●
TRMS voltage	●
Frequency	●
Active, Reactive and Apparent power	●
Power factor	●
Operating timer, countdown timer	●
Active, Reactive and Apparent energy	●
4 quadrants Energy (Import/Export)	●
THD (I, VLN, VLL)	●
Neutral current	Calculated
Single alarms	25
Demand values (average)	Basic
Max/min values	Basic
Warnings, alarms and errors logs	●
Digital Outputs	2
<b>+PQ1</b>	
Individual Harmonics	25 <sup>th</sup>
Unbalances	●
Historicals logs	Intermediate
RTC	●
<b>+PQ2</b>	
Individual Harmonics	40 <sup>th</sup>
Unbalances	●
Historicals logs	Advanced
RTC	●
Neutral current	Measured
<b>+RTS</b>	
Tariffs	6
Complex alarms with logics	4
RTC	●
Programmable I/O <sup>1</sup>	4
<b>Connectivity</b>	
Automatic integration in ABB Ability™ Energy and Asset Manager	●
Automatic integration in System pro M compact InSite	●
Bluetooth Low Energy	●
Communication Protocols	Modbus RTU, Modbus TCP/IP
RJ45 Daisy Chain (Ethernet version)	●

<sup>1</sup> instead of 2 Digital Outputs

# Ordering codes



## M4M 20

M4M 20 is ABB's network analyzer range that provides complete and accurate electrical parameters monitoring and basic power quality analysis.

Equipped with graphic color display for advanced visualization of the measured parameters and Bluetooth module for smart commissioning.

Communication protocol	I/O	Type code	Order code	Weight 1 piece kg	Pack unit pc.	L.P. (₹)
BLE	2 Digital out.	M4M 20	2CSG251151R4051	0,400	1	Upon request
BLE, Modbus RTU	2 Digital out.	M4M 20 Modbus	2CSG251141R4051	0,400	1	
BLE, Modbus TCP/IP	2 Digital out.	M4M 20 Ethernet	2CSG204471R4051	0,400	1	
BLE, Profibus DP-V0	2 Digital out.	M4M 20 Profibus	2CSG251131R4051	0,400	1	
BLE, BACnet/IP	2 Digital out.	M4M 20 Bacnet	2CSG236831R4051	0,400	1	
BLE, Modbus RTU	2 Progr. I/O, 2 Digital out., 2 Analogue out.	M4M 20 I/O	2CSG251161R4051	0,400	1	
<b>MID</b> LE, Modbus RTU	2 Digital out.	M4M 20-M MODBUS	2CSG239055R4051	0,400	1	
<b>MID</b> BLE, Modbus TCP/IP	2 Digital out.	M4M 20-M ETHERNET	2CSG239065R4051	0,400	1	



## M4M 20 - ROGOWSKI VERSION

M4M 20 is also available as compatible with ABB's R4M Rogowski coils for current measurement, increasing the flexibility of network analyzers offer and allowing retrofit in any existing installations.

M4M 20 Rogowski together with R4M Rogowski coils ensures the integration of basic power quality metering in any existing system with 0 downtime.

Communication protocol	I/O	Type code	Order code	Weight 1 piece kg	Pack unit pc.	L.P. (₹)
BLE, Modbus TCP/IP	2 Digital Outputs	M4M 20 Rogowski	2CSG207081R4051	0,400	1	Upon request

# Ordering codes



## M4M 30

M4M 30 is ABB's network analyzer range that allows complete power quality analysis and energy efficiency evaluations.

Equipped with touchscreen color display for simplified access to the device and with Bluetooth module for smart commissioning.

Communication protocol	I/O	Type code	Order code	Weight 1 piece kg	Pack unit pc.	L.P. (₹)
BLE, Modbus RTU	4 Progr. I/O	M4M 30 Modbus	2CSG274761R4051	0,400	1	Upon request
BLE, Modbus TCP/IP	4 Progr. I/O	M4M 30 Ethernet	2CSG274681R4051	0,400	1	
BLE, Profibus DP-V0	4 Progr. I/O	M4M 30 Profibus	2CSG236791R4051	0,400	1	
BLE, BACnet/IP	4 Progr. I/O	M4M 30 Bacnet	2CSG202451R4051	0,400	1	
BLE, Modbus RTU	6 Progr. I/O, 2 Analogue out.	M4M 30 I/O	2CSG202471R4051	0,400	1	
<b>MID</b> BLE, Modbus RTU	4 programmable I/O	M4M 30-M MODBUS	2CSG239035R4051	0,400	1	
<b>MID</b> BLE, Modbus TCP/IP	4 programmable I/O	M4M 30-M ETHERNET	2CSG239045R4051	0,400	1	



## M4M 30 - ROGOWSKI VERSION

M4M 30 is also available as compatible with ABB's R4M Rogowski coils for current measurement, increasing the flexibility of network analyzers and allowing retrofit in any existing installations. M4M 30 Rogowski together with R4M coils ensure integration of complete PQ analysis in any existing system with 0 downtime.

Communication protocol	I/O	Type code	Order code	Weight 1 piece kg	Pack unit pc.	L.P. (₹)
BLE, Modbus RTU	4 Progr. I/O	M4M 30 Rogowski	2CSG202461R4051	0,400	1	Upon request

## R4M ROGOWSKI COILS



R4M Rogowski coils are flexible current transformer based on Rogowski technology, ideal to retrofit existing installations up to 12kA. Available in two different sizes (80mm or 200mm diameters), R4M coils are directly equipped with pre-wired removable terminals that perfectly fit M4M 20 Rogowski (3 Rogowski coil inputs) and M4M 30 Rogowski (4 Rogowski coil inputs), with no need for external integrators.

Diameter (mm)	Type code	Order code	Weight 1 piece kg	Pack unit pc.	L.P. (₹)
80	R4M-80	2CSG202160R1101	0,150	1	Upon request
200	R4M-200	2CSG202150R1101	0,250	1	

# Ordering codes



## M4M 2X

M4M 2X is ABB's network analyzer range that ensuring higher flexibility to project specifications compared to standard network analyzers. M4M 2X is available without display, only communicating via protocols and Bluetooth module for smart remote commissioning.

Communication protocol	I/O	Functionality package	Type code	Order code	Weight 1 piece kg	Pack unit pc.	L.P. (₹)
BLE, Modbus RTU	2 Digital out.	2X	M4M 2X Modbus	2CSG260111R4051			
BLE, Modbus TCP/IP	2 Digital out.	2X	M4M 2X Ethernet	2CSG260061R4051			
BLE, Modbus RTU	2 Digital out.	2X+PQ1	M4M 2X Modbus PQ1	2CSG239075R4051			
BLE, Modbus TCP/IP	2 Digital out.	2X+PQ1	M4M 2X Ethernet PQ1	2CSG239125R4051			
BLE, Modbus RTU	2 Digital out.	2X+PQ2	M4M 2X Modbus PQ2	2CSG239085R4051			
BLE, Modbus TCP/IP	2 Digital out.	2X+PQ2	M4M 2X Ethernet PQ2	2CSG239135R4051			
BLE, Modbus RTU	4 Progr. I/O	2X+RTS	M4M 2X Modbus RTS	2CSG239095R4051			Upon request
BLE, Modbus TCP/IP	4 Progr. I/O	2X+RTS	M4M 2X Ethernet RTS	2CSG239145R4051			
BLE, Modbus RTU	4 Progr. I/O	2X+PQ1+RTS	M4M 2X Modbus PQ1+RTS	2CSG239105R4051			
BLE, Modbus TCP/IP	4 Progr. I/O	2X+PQ1+RTS	M4M 2X Ethernet PQ1+RTS	2CSG239155R4051			
BLE, Modbus RTU	4 Progr. I/O	2X+PQ2+RTS	M4M 2X Modbus PQ2+RTS	2CSG239115R4051			
BLE, Modbus TCP/IP	4 Progr. I/O	2X+PQ2+RTS	M4M 2X Ethernet PQ2+RTS	2CSG239165R4051			



---

Complete integration in the ABB's scalable solutions for energy and asset management, to protect assets and optimize costs and energy needs

**Full connectivity...**

**...for integration with ABB Ability™ system**



# Measurement devices

## EQ matic energy meters selection table



	EQ meters C11	EQ meters C13	EQ meters B21	EQ meters B23	EQ meters B24
Overall dimensions	1 DIN module	3 DIN modules	2 DIN modules	4 DIN modules	4 DIN modules
Display	LCD	LCD	Backlit LCD	Backlit LCD	Backlit LCD
Operating voltage	230 V AC	3x230/400 V AC	220...240 V AC	3x220/380...240/415 V AC	
Frequency					50 / 60 Hz
Max current	40 A	40 A	65 A	65 A	6 A
CTVT connected	-	-	-	-	CT
Active energy					
Reactive energy	-	-			
Apparent energy	-	-	optional		
Accuracy	Cl. 1	Cl. 1 (B)	Cl. 1 (B)	Cl. 1 (B)	Cl. 1 (B), Cl. 0,5 S (C)
Tariff	-	-	optional		
Event log	-	-			
Maximum demand	-	-	-	-	-
Previous values	-	-	-	-	-
Load profiles	-	-	-	-	-
Harmonic analysis	-	-	-	-	-
Alarm function					
Voltage					
Current					
Power factor					
Frequency	-	-	optional		
Pulse output					
Outputs	-	-	optional		
Inputs	-	-			
Built-in serial communication	-	-	IR, M-Bus, RS-485		
Protocols	-	-	M-Bus, Modbus RTU, EQ bus		



EQ meters A41	EQ meters A42	EQ meters A43	EQ meters A44	EQ meters G13
4 DIN modules	4 DIN modules	7 DIN modules	7 DIN modules	4 DIN modules
Backlit Pixel (LCD)	Backlit Pixel (LCD)	Backlit Pixel (LCD)	Backlit Pixel (LCD)	No display
	57.7...288 V AC		3 x 57.7/100...288/500 V AC	100...240 V AC
				50 / 60 Hz
80 A	6 A	80 A	6 A	-
-	CTVT	-	CTVT	-
				-
			optional	-
Cl. 1 (B)	Cl. 1 (B), Cl. 0,5 S (C)	Cl. 1 (B)	Cl.1 (B), Cl. 0,5 S (C)	-
			optional	-
				-
				-
			optional	-
				-
				-
			optional	-
				-
			optional	-
				-
			IR, M-Bus, RS-485	IR, RS-485, M-Bus
			M-Bus, Modbus, EQ bus	EQ bus, M-Bus, JSON

# Measurement devices

## Circuit Monitoring System

The quality of a Circuit Monitoring System is dependent on the strengths of the individual components and how well they interact. ABB's CMS sets the bar particularly high. Regardless of whether we're talking compactness, technology,

measurement results, user friendliness or flexibility, every component and every feature of this CMS has been fully optimized in terms of practicality and functionality.

**Example illustration:**  
Control Unit CMS-700 in combination with CMS open-core sensors



CMS-700

**CMS bus interface**  
A bus interface allows up to 32 sensors to be connected to the Control Unit.

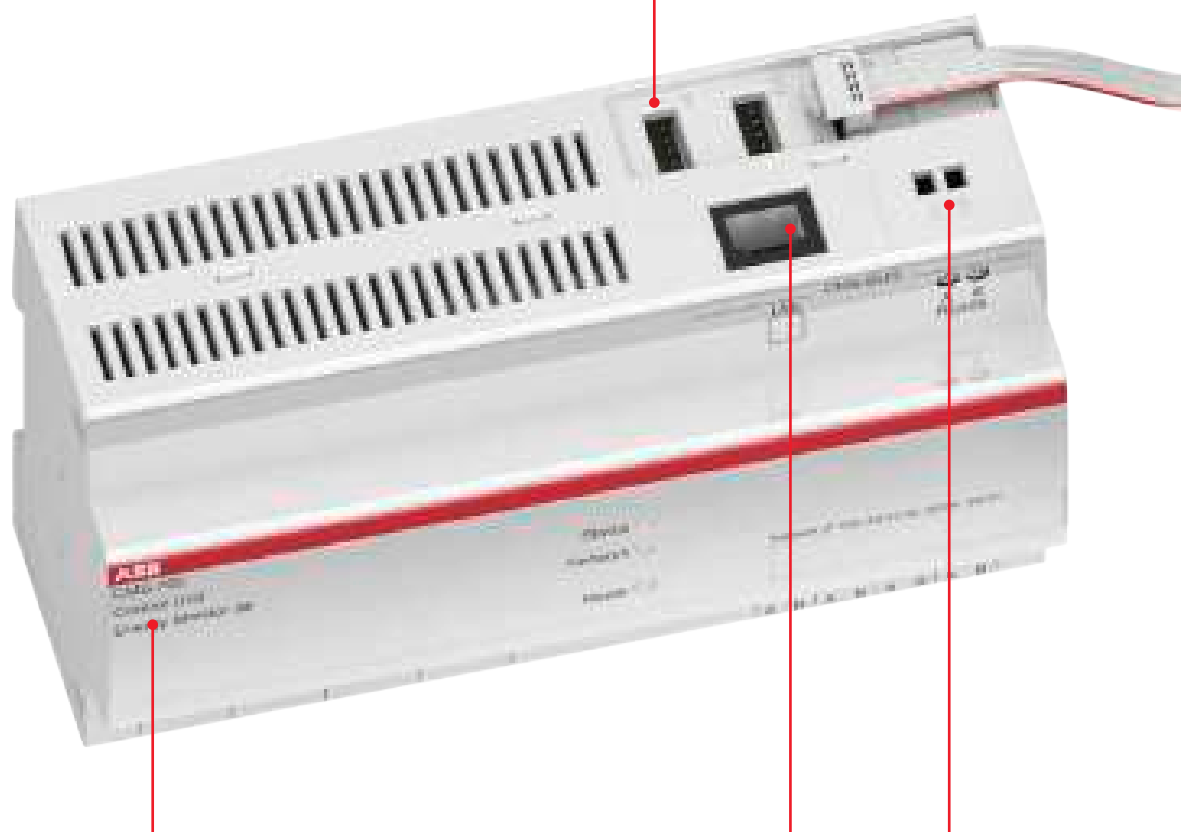

### Control Units

The Control Unit is a kind of computing and communication center that, depending on the equipment connected to it, evaluates the different data picked up by the sensors and makes it available via the built-in interfaces.

You have a choice of three different units depending on your applications: CMS-600 and CMS-700.

### Serial interfaces

Depending on the unit, numerous interfaces and protocols are available to ensure smooth network implementation: RS485 (Modbus RTU), LAN (TCP/IP and Modbus TCP), SNMP v1/v2 and encrypted v3.

Thanks to the built-in web server, an internet browser or a free Android or iOS app can be used to visualize the values measured. What's more, the measured values can also be exported to CSV files.

**Integrate however you want, thanks to multiple mounting options.**

Depending on the application, choose between up to four different mounting options to make integrating the CMS sensors in your installation as simple and as uncomplicated as possible.

**Universally usable sensor designs**



**Mounting on a DIN rail**  
CMS-120DR, CMS-100DR, and CMS-200DR series sensors can be mounted on all DIN rails with the aid of a DIN rail mounting.



**Cable tie mounting**  
If space is at a real premium, CMS-120CA, CMS-100CA, and CMS-200CA series sensors can be secured directly to the cable(s) to be measured by means of cable ties.

**Tangible value addition for you ABB circuit monitoring pays off two-fold**



**Early warning system (predictive maintenance) for increasing the availability of critical consumers**  
Continuous monitoring of the current flow at the circuit breaker makes it possible to detect overloaded lines before they lead to a service interruption. Apart from this, monitoring individual circuits indicates whether the loads are in the desired operating mode or not. In this way, system deviations can be ascertained instantaneously. What's more, the CMS can be used to detect unbalanced loads before they result in failure of the neutral conductor and consequently load failure.

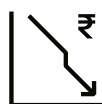

**Cost analysis to reduce and assign energy costs**  
The cost of energy will rise continuously. In order to cut costs, you first have to know where they arise. The Control Unit helps illustrate and analyze the instantaneous energy consumption levels. Furthermore, the calculated active energy can be used to roughly allocate the costs at the output level.

---

## ABB ITUS Distribution boards

Performance redefined

---

At ABB we look at global trends along with advances in innovation, along the line of power enclosures. Keeping these factors in mind, using advanced techniques and vast domain expertise, we come up with products that are future ready.

Keeping pace with new requirements coupled with dynamic changes in the business space, our products are designed so that they meet multiple objectives and desires of our customers.

Our products are designed to give maximum convenience and customization options, providing a true sense of freedom and choice for all your wiring needs.



# Suitable for installation in Mivan construction

- Inner/outer folded back box provided with regular cutout on the top portion to increase the mechanical strength of the DB
- DB Box provided with cement guard so that slurry doesn't enter the DB box during concreting
- Removable frame is provided to facilitate adjustments owing to civil work, like plastering
- Once plastering is completed, frame and door are installed. Since thickness of plaster itself is 8 mm to 10 mm, the screws used to fix frame with the DB box have to be long enough, Hence long screws are provided to meet the requirement.



ITUS



Elegance

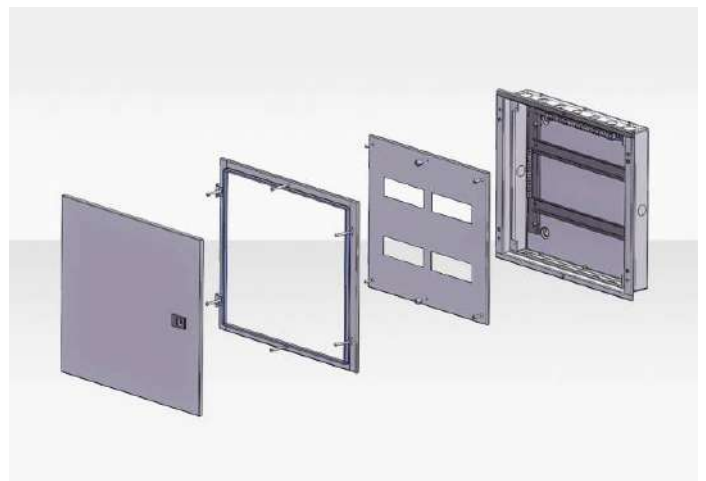

# ABB ITUS Distribution boards

## SPN-SHC

Horizontal single phase consumer unit with provision for 2 pole (MCB/Isolator/RCD) incoming and single phase outgoing. These distribution boards come with earth link, shrouded neutral link and tinned electrolytic copper insulated busbar. Top and bottom, removable gland plates with knockouts. Mounting of these boards can be flush or surface.



### IP 30, IK 08 Without door

Product description	Product code	No. of ways	No. of modules	Unit MRP (₹)
I-SPN06 WAY WD DB	1SYM011506C0001 ■	6 way	6	1,960
I-SPN08 WAY WD DB	1SYM011508C0001 ■	8 way	8	2,290
I-SPN10 WAY WD DB	1SYM011510C0001	10 way	10	2,530
I-SPN12 WAY WD DB	1SYM011512C0001 ■	12 way	12	2,660
I-SPN14 WAY WD DB	1SYM011514C0001	14 way	14	3,050
I-SPN16 WAY WD DB	1SYM011516C0001	16 way	16	3,460
I-SPN18 WAY WD DB	1SYM011518C0001 ■	18 way	18	3,940
I-SPN22 WAY WD DB	1SYM011522C0001	22 way	22	4,030



### IP 43, IK 09 With metal door

Product description	Product code	No. of ways	No. of modules	Unit MRP (₹)
I-SPN06 WAY MD DB	1SYM011606C0001 ■	6 way	6	2,910
I-SPN08 WAY MD DB	1SYM011608C0001 ■	8 way	8	3,340
I-SPN10 WAY MD DB	1SYM011610C0001	10 way	10	3,840
I-SPN12 WAY MD DB	1SYM011612C0001 ■	12 way	12	3,940
I-SPN14 WAY MD DB	1SYM011614C0001	14 way	14	4,610
I-SPN16 WAY MD DB	1SYM011616C0001	16 way	16	4,910
I-SPN18 WAY MD DB	1SYM011618C0001 ■	18 way	18	5,240
I-SPN22 WAY MD DB	1SYM011622C0001	22 way	22	6,050



### IP 43, IK 09 Metal door with acrylic

Product description	Product code	No. of ways	No. of modules	Unit MRP (₹)
I-SPN06 WAY AD DB	1SYM011706C0001	6 way	6	4,310
I-SPN08 WAY AD DB	1SYM011708C0001	8 way	8	4,960
I-SPN10 WAY AD DB	1SYM011710C0001	10 way	10	5,240
I-SPN12 WAY AD DB	1SYM011712C0001	12 way	12	5,700
I-SPN14 WAY AD DB	1SYM011714C0001	14 way	14	6,180
I-SPN16 WAY AD DB	1SYM011716C0001	16 way	16	6,490
I-SPN18 WAY AD DB	1SYM011718C0001	18 way	18	7,120
I-SPN22 WAY AD DB	1SYM011722C0001	22 way	22	7,840



### IP 54, IK 09 Metal door

Product description	Product code	No. of ways	No. of modules	Unit MRP (₹)
I-SPN06 WAY WP DB	1SYM011806C0001	6 way	6	7,340
I-SPN08 WAY WP DB	1SYM011808C0001	8 way	8	9,370
I-SPN10 WAY WP DB	1SYM011810C0001	10 way	10	9,480
I-SPN12 WAY WP DB	1SYM011812C0001	12 way	12	10,760
I-SPN14 WAY WP DB	1SYM011814C0001	14 way	14	11,220
I-SPN16 WAY WP DB	1SYM011816C0001	16 way	16	11,970
I-SPN18 WAY WP DB	1SYM011818C0001	18 way	18	12,570
I-SPN22 WAY WP DB	1SYM011822C0001	22 way	22	13,440

■ Stock items



# ABB ITUS Distribution boards

## TPN-SHDB horizontal

Horizontal three phase distribution board with provision for incomer 8 pole (MCB/Isolator/RCD) and single phase outgoing. These distribution boards come with earth link, shrouded neutral link, tinned electrolytic copper insulated busbar and wire sets for cable management. Top and bottom, removable gland plates with knockouts. Mounting of these boards can be flush or surface.



### IP 30, IK 08 Without door

Product description	Product code	No. of ways	No. of modules		Unit MRP (₹)
			I/C	O/G	
I-TPN04 WAY WD DB	1SYM021504C0001 ■	4 way	8	12	5,350
I-TPN06 WAY WD DB	1SYM021506C0001 ■	6 way	8	18	6,790
I-TPN08 WAY WD DB	1SYM021508C0001 ■	8 way	8	24	7,820
I-TPN12 WAY WD DB	1SYM021512C0001 ■	12 way	8	36	11,600



### IP 43, IK 09 With metal door

Product description	Product code	No. of ways	No. of modules		Unit MRP (₹)
			I/C	O/G	
I-TPN04 WAY MD DB	1SYM021604C0001 ■	4 way	8	12	6,720
I-TPN06 WAY MD DB	1SYM021606C0001 ■	6 way	8	18	7,950
I-TPN08 WAY MD DB	1SYM021608C0001 ■	8 way	8	24	9,370
I-TPN12 WAY MD DB	1SYM021612C0001 ■	12 way	8	36	13,640

### IP 43, IK 09 Metal door with acrylic

Product description	Product code	No. of ways	No. of modules		Unit MRP (₹)
			I/C	O/G	
I-TPN04 WAY AD DB	1SYM021704C0001	4 way	8	12	8,010
I-TPN06 WAY AD DB	1SYM021706C0001	6 way	8	18	9,900
I-TPN08 WAY AD DB	1SYM021708C0001	8 way	8	24	11,860
I-TPN12 WAY AD DB	1SYM021712C0001	12 way	8	36	18,190

### IP 54, IK 09 Metal door

Product description	Product code	No. of ways	No. of modules		Unit MRP (₹)
			I/C	O/G	
I-TPN04 WAY WP DB	1SYM021804C0001	4 way	8	12	20,260
I-TPN06 WAY WP DB	1SYM021806C0001	6 way	8	18	24,220
I-TPN08 WAY WP DB	1SYM021808C0001	8 way	8	24	26,490
I-TPN12 WAY WP DB	1SYM021812C0001	12 way	8	36	37,320

■ Stock items

## ABB ITUS Distribution boards

### TPN-SHPPI horizontal per phase isolation

Horizontal per-phase isolation distribution board with provision for 8 pole (MCB/Isolator/RCD) as incomer, 3 DP MCB/Isolator/RCD as sub-incoming and SP MCBs as outgoing. These distribution boards come with separate shrouded neutral link for each phase, earthing link, tinned electrolytic copper insulated busbar and wire sets for cable management. Top and bottom removable gland plates with knockouts. Mounting of these boards can be flush or surface.



#### IP 43, IK 09 With metal door

Product description	Product code	No. of ways	No. of modules			Unit MRP (₹)
			I/C	Sub I/C	O/G	
I-HPPI06 WAY MD DB	1SYM031606C0001 ■	6 way	8	6	12	13,300
I-HPPI08 WAY MD DB	1SYM031608C0001 ■	8 way	8	6	18	15,770
I-HPPI12 WAY MD DB	1SYM031612C0001 ■	12 way	8	6	30	17,930

## ABB ITUS Distribution boards

### TPN-SVDB vertical per phase isolation

Vertical per-phase Isolation Distribution Board in 4-tier structure with provision for 8 pole (MCB/ Isolator/ RCD) incomer and 2 pole (MCB/Isolator/RCD) as sub-incomer with single phase outgoing. These distribution boards come with separate shrouded neutral link for each phase, earthing link, tinned electrolytic copper insulated busbar and wire sets for cable management. Top and bottom removable gland plates with knockouts. Mounting of these boards can be flush or surface.



#### IP 43, IK 09 With metal door

Product description	Product code	No. of ways	No. of modules			Unit MRP (₹)
			I/C	Sub I/C	O/G	
I-VPPI06 WAY MD DB	1SYM041606C0001 ■	6 way	8	6	18	12,780
I-VPPI08 WAY MD DB	1SYM041608C0001 ■	8 way	8	6	24	15,150
I-VPPI12 WAY MD DB	1SYM041612C0001 ■	12 way	8	6	36	17,230

■ Stock items

# ABB ITUS Distribution boards

## TPN-8 segment

Eight segment distribution board with phase segregation and separation between incoming and outgoing with provision for 4P+8P incomer (MCB/Isolator/RCD) and 4 pole sub-incomer (MCB/Isolator/RCD) with single phase outgoing. These distribution boards come with shrouded neutral bar, earthing link and wire sets for cable management for each compartment. Top and bottom, removable gland plates with knockouts. Mounting of these boards can be flush or surface.



### IP 43, IK 09 With metal door

Product description	Product code	No. of ways	No. of modules			Unit MRP (₹)
			I/C	Sub I/C	O/G	
I-8SEG04 WAY MD DB	1SYM051604C0001 ■	4 way	4+8	12	12	17,780
I-8SEG06 WAY MD DB	1SYM051606C0001 ■	6 way	4+8	12	18	19,980
I-8SEG08 WAY MD DB	1SYM051608C0001 ■	8 way	4+8	12	24	22,260
I-8SEG12 WAY MD DB	1SYM051612C0001	12 way	4+8	12	36	27,690

# ABB ITUS Distribution boards

## VTPN-SVTDB MCB vertical type

Vertical three phase distribution board with provision for 8 pole (MCB/Isolator/RCD) incoming with three phase and single phase (TP/SP) outgoing. These distribution boards come with complete insulated busbar (tinned electrolytic copper) arrangement, shrouded neutral bar and earth bars. Top and bottom removable gland plates with knockouts. Mounting of these boards can be flush or surface.



### IP 43, IK 09 Metal door

Product description	Product code	No. of ways	No. of modules		Unit MRP (₹)
			I/C	O/G	
I-VTPN04 WAY MCB/IC MD DB	1SYM061604C0001 ■	4 way	8	12	16,960
I-VTPN06 WAY MCB/IC MD DB	1SYM061606C0001 ■	6 way	8	18	19,320
I-VTPN08 WAY MCB/IC MD DB	1SYM061608C0001 ■	8 way	8	24	20,960
I-VTPN12 WAY MCB/IC MD DB	1SYM061612C0001	12 way	8	36	28,650

## ABB ITUS Distribution boards

### TPN-SVTDB XT1 vertical 160A MCCB

Vertical three phase distribution board with provision for 4 pole MCCB (XT1) up to 160A as incomer with three phase and single phase (TP/SP) MCB outgoing. These distribution boards come with complete insulated busbar (tinned electrolytic copper) arrangement, shrouded neutral bar and earth bars. Top and bottom removable gland plates with knockouts. Mounting of these boards can be flush or surface.



#### IP 43, IK 09 Metal door

Product description	Product code	No. of ways	No. of modules		Unit MRP (₹)
			I/C	O/G	
I-VTPN04 WAY XT1/IC MD DB	1SYM071604C0001	4 way	XT1 160	12	19,600
I-VTPN06 WAY XT1/IC MD DB	1SYM071606C0001	6 way	XT1 160	18	22,180
I-VTPN08 WAY XT1/IC MD DB	1SYM071608C0001	8 way	XT1 160	24	24,240
I-VTPN12 WAY XT1/IC MD DB	1SYM071612C0001	12 way	XT1 160	36	31,900

## ABB ITUS Distribution Boards

### TPN-SVTDB XT3 vertical 250A MCCB

Vertical three phase distribution board with provision for 4 pole MCCB (XT3) up to 250A as incomer with three phase and single phase (TP/SP) MCB outgoing. These distribution boards come with complete insulated busbar (tinned electrolytic copper) arrangement, shrouded neutral bar and earth bars. Top and bottom removable gland plates with knockouts. Mounting of these boards can be flush or surface.



#### IP 43, IK 09 Metal door

Product description	Product code	No. of ways	No. of modules		Unit MRP (₹)
			I/C	O/G	
I-VTPN04 WAY XT3/IC MD DB	1SYM081604C0001	4 way	XT3 250	12	34,070
I-VTPN06 WAY XT3/IC MD DB	1SYM081606C0001	6 way	XT3 250	18	35,940
I-VTPN08 WAY XT3/IC MD DB	1SYM081608C0001	8 way	XT3 250	24	39,660
I-VTPN12 WAY XT3/IC MD DB	1SYM081612C0001	12 way	XT3 250	36	41,600

# ABB ITUS Distribution boards

## SVFLM flexy tier

Total flexibility as per site needs - configuration as per your choice of incomer and outgoing. Supply busbars need to be selected. These distribution boards come with shrouded neutral link, earthing link. Top and bottom, removable gland plates with knockouts. Mounting of these boards can be flush or surface.



### IP 43, IK 09 Metal door

Product description	Product code	No. of ways	No. of rows	No. of modules	Unit MRP (₹)
I-2 ROW 13 MOD DB	1SYM101632C0001	2 Row of 13 Mod	2	26	7,820
I-2 ROW 14 MOD DB	1SYM101642C0001	2 Row of 14 Mod	2	28	9,020
I-3 ROW 13 MOD DB	1SYM101633C0001	3 Row of 13 Mod	3	39	9,500
I-3 ROW 14 MOD DB	1SYM101643C0001	3 row of 14 Mod	3	42	9,940
I-4 ROW 13 MOD DB	1SYM101634C0001	4 Row of 13 Mod	4	52	11,570
I-4 ROW 14 MOD DB	1SYM101644C0001	4 Row of 14 Mod	4	56	12,220

# ABB ITUS Distribution Boards

## SPVS phase selector type

Phase selector distribution boards with in-built 3 numbers of selector switches and 3 numbers of piano switches as well as provision for 8 pole MCB/Isolator/RCD as incoming and SP MCBs as outgoing. These distribution boards come with earth link, shrouded neutral link, tinned electrolytic insulated copper busbar and wire sets for cable management. Top and bottom, removable gland plates with knockouts. Mounting of these boards can be flush or surface.



### IP 43, IK 09 Metal door

Product description	Product code	No. of ways	No. of modules I/C	No. of modules O/G	Unit MRP (₹)
I-PS 63A04 WAY MD DB	1SYM091604C0001	4 way	8	12	22,300
I-PS 63A06 WAY MD DB	1SYM091606C0001	6 way	8	18	22,300
I-PS 63A08 WAY MD DB	1SYM091608C0001	8 way	8	24	24,500
I-PS 63A12 WAY MD DB	1SYM091612C0001	12 way	8	36	26,730

# ABB ITUS Distribution Boards

## SEN enclosures

Metal enclosures, universal mounting suitable for 2M, 4M, 6M and 8M arrangements.



### IP 20, IK 08

Product description	Product code	No. of ways	No. of modules	Unit MRP (₹)
I- 2MOD Metal Enclosure	1SYM121502C0001 ■	2P enclosure	2	1,020
I- 4MOD Metal Enclosure	1SYM121504C0001 ■	4P enclosure	4	1,030
I- 6MOD Metal Enclosure	1SYM121506C0001 ■	6P enclosure	6	1,400
I- 8MOD Metal Enclosure	1SYM121508C0001 ■	8P enclosure	8	1,670

# ABB ITUS Distribution Enclosures

## Plug & socket boards

This range offers a wide variety of plug & socket boards. These plugs & sockets can be used for single phase or three phase applications up to 30A along with MCB or RCBO with provision for universal mounting.



### IP 20, IK 08

Product description	Product code	No. of ways	No. of modules	Unit MRP (₹)
I- 20A SP 2Pin P&S Enclosure	1SYM111520C0001 ■	1	2	2,620
I- 30A TP 3Pin P&S Enclosure	1SYM111530C0001 ■	1	4	5,610

# ABB ITUS Distribution Boards

## Cable end boxes

### SPN-SHC

Product description	Product code	No. of ways	Unit MRP (₹)
I-SPN06 WAY MD CEB	1SYM140106C0001	6 way	930
I-SPN08 WAY MD CEB	1SYM140108C0001	8 way	1,140
I-SPN10 WAY MD CEB	1SYM140110C0001	10 way	1,200
I-SPN12 WAY MD CEB	1SYM140112C0001	12 way	1,330
I-SPN14 WAY MD CEB	1SYM140114C0001	14 way	1,440
I-SPN16 WAY MD CEB	1SYM140116C0001	16 way	1,630
I-SPN18 WAY MD CEB	1SYM140118C0001	18 way	1,950
I-SPN22 WAY MD CEB	1SYM140122C0001	22 way	2,070

### TPN-SHDB

Product description	Product code	No. of ways	Unit MRP (₹)
I-TPN04 WAY MD CEB	1SYM140204C0001	4 way	1,400
I-TPN06 WAY MD CEB	1SYM140206C0001	6 way	1,950
I-TPN08 WAY MD CEB	1SYM140208C0001	8 way	3,400
I-TPN12 WAY MD CEB	1SYM140212C0001	12 way	4,640

### TPN-SHPPI

Product description	Product code	No. of ways	Unit MRP (₹)
I-HPPI06 WAY MD CEB	1SYM140306C0001	6 way	1,950
I-HPPI08 WAY MD CEB	1SYM140308C0001	8 way	3,400
I-HPPI12 WAY MD CEB	1SYM140312C0001	12 way	4,640

### TPN-SVDB

Product description	Product code	No. of ways	Unit MRP (₹)
I-VPPI06 WAY MD CEB	1SYM140406C0001	6 way	1,670
I-VPPI08 WAY MD CEB	1SYM140408C0001	8 way	1,670
I-VPPI12 WAY MD CEB	1SYM140412C0001	12 way	1,910

### 8 Segment

Product description	Product code	No. of ways	Unit MRP (₹)
I-8SEG04 WAY MD CEB	1SYM141013C0001	4 way	2,470
I-8SEG06 WAY MD CEB	1SYM141014C0001	6 way	3,800
I-8SEG08 WAY MD CEB	1SYM140600C0001	8 way	5,600
I-8SEG12 WAY MD CEB	1SYM140700C0001	12 way	7,740

### SVTDB, XT1 & XT3

Product description	Product code	No. of ways	Unit MRP (₹)
I-VTPN MCB/IC MD CEB	1SYM140800C0001	For all SVTDB MCB I/C	3,190
I-VTPN XT1/IC MD CEB	1SYM140504C0001	For all SVTDB MCCB XT1 I/C	5,050
I-VTPN XT3/IC MD CEB	1SYM140506C0001	For all SVTDB MCCB XT3 I/C	5,050

### SVFLM

Product description	Product code	No. of ways	Unit MRP (₹)
I- 13 MOD CEB	1SYM140508C0001	13 module	2,070
I-14 MOD CEB	1SYM140512C0001	14 module	2,470

### Busbars and blanking plate

Product description	Product code	No. of ways	No. of modules	Unit MRP (₹)
I- 13 MOD Insulated Busbar	1SYM131514C0001	13		520
I- 14 MOD Insulated Busbar	1SYM131500C0001	14		520
I- Blank Plate	1SYM131513C0001		1	27

# Elegance series

## Distribution boards

Elegance series (E-series) distribution boards are available in texture grey (color code - RAL7035)

### Construction

Blending aesthetics, functionality and safety, the E-series of ABB distribution boards are manufactured with high precision, and high quality CRCA steel sheets. These distribution boards undergo a seven-tank phosphating process to ensure anti-rust conditioning, superior finish and lasting strength. Premier quality powder coating is applied using the latest techniques

### Colour

ABB's E-series of distribution boards is available in texture grey (RAL 7035)

### Installation

The E-series of ABB distribution boards are universal mounting type, hence can be flush or wall mounted. These distribution boards are provided with top and bottom removable gland plates with adequate no of knock outs, which enable easy installation and connection of conduits of sizes up to 32 mm dia knock out.

### Protection

E-series distribution boards offer three types of protection- IP43 & IP54 degree with a metal door and IP30 degree without a door. The highest degree of attention has been paid to the safety aspect of the distribution boards, considering that they are installed in close proximity to people. An intermediate plate ensures total safety, as no live parts are exposed when the door is opened.





# Elegance series

## Distribution boards

### SPN DB -E-SHC

Horizontal single phase consumer unit with provision for incoming 2 pole (MCB / Isolator / RCD) and single phase outgoing. Suitable for surface and flush mounting.

#### IP 30



Product description	Ordering code	No. of ways	No of modules	Unit MRP (₹)
E-SHC WD 4	1SYE011504C0001 ■	4 way	4+2	1,770
E-SHC WD 6	1SYE011506C0001	6 way	6+2	2,000
E-SHC WD 8	1SYE011508C0001 ■	8 way	8+2	2,280
E-SHC WD 10	1SYE011510C0001	10 way	10+2	2,420
E-SHC WD 12	1SYE011512C0001 ■	12 way	12+2	2,750
E-SHC WD 14	1SYE011514C0001	14 way	14+2	3,110
E-SHC WD 16	1SYE011516C0001 ■	16 way	16+2	3,540
E-SHC WD 20	1SYE011520C0001	20 way	20+2	3,990

#### IP 43 with metal door



Product description	Ordering code	No. of ways	No. of modules	Unit MRP (₹)
E-SHC M 4	1SYE011604C0001 ■	4 way	4+2	2,800
E-SHC M 6	1SYE011606C0001	6 way	6+2	3,020
E-SHC M 8	1SYE011608C0001 ■	8 way	8+2	3,490
E-SHC M 10	1SYE011610C0001	10 way	10+2	3,650
E-SHC M 12	1SYE011612C0001 ■	12 way	12+2	4,190
E-SHC M 14	1SYE011614C0001	14 way	14+2	4,460
E-SHC M 16	1SYE011616C0001 ■	16 way	16+2	5,030
E-SHC M 20	1SYE011620C0001	20 way	20+2	5,860

#### IP 43 Metal door with acrylic



Product description	Ordering code	No. of ways	No. of modules	Unit MRP (₹)
E-SHC P 4	1SYE011704C0001	4 way	4+2	3,280
E-SHC P 6	1SYE011706C0001	6 way	6+2	3,630
E-SHC P 8	1SYE011708C0001	8 way	8+2	3,840
E-SHC P 10	1SYE011710C0001	10 way	10+2	4,400
E-SHC P 12	1SYE011712C0001	12 way	12+2	4,820
E-SHC P 14	1SYE011714C0001	14 way	14+2	5,240
E-SHC P 16	1SYE011716C0001	16 way	16+2	5,860
E-SHC P 20	1SYE011720C0001	20 way	20+2	6,870

#### IP 54

Product Description	Ordering code	No. of ways	No. of modules	Unit MRP (₹)
E-SHC M WP 4	1SYE011804C0001	4 way	4+2	7,290
E-SHC M WP 6	1SYE011806C0001	6 way	6+2	7,910
E-SHC M WP 8	1SYE011808C0001	8 way	8+2	8,460
E-SHC M WP 10	1SYE011810C0001	10 way	10+2	9,080
E-SHC M WP 12	1SYE011812C0001	12 way	12+2	9,920
E-SHC M WP 14	1SYE011814C0001	14 way	14+2	10,110
E-SHC M WP 16	1SYE011816C0001	16 way	16+2	10,990
E-SHC M WP 20	1SYE011820C0001	20 way	20+2	11,760

■ Stock items

# Elegance series

## Distribution boards

### TPN DB - E-SHDB horizontal

Horizontal three phase distribution board provision for incomer 8 pole (MCB / Isolator / RCD) and single phase outgoings suitable for both surface & flush mounting.

#### IP 30

Product description	Ordering code	No. of ways	No. of modules	Unit MRP (₹)
E-SHDB WD 4	1SYE021504C0001 ■	4 way	8+12	4,810
E-SHDB WD 6	1SYE021506C0001	6 way	8+18	5,430
E-SHDB WD 8	1SYE021508C0001 ■	8 way	8+24	6,390
E-SHDB WD 12	1SYE021512C0001 ■	12 way	8+36	9,370

#### IP 43 with metal door

Product description	Ordering code	No. of ways	No. of modules	Unit MRP (₹)
E-SHDB M 4	1SYE021604C0001 ■	4 way	8+12	6,530
E-SHDB M 6	1SYE021606C0001	6 way	8+18	7,410
E-SHDB M 8	1SYE021608C0001 ■	8 way	8+24	8,510
E-SHDB M 12	1SYE021612C0001 ■	12 way	8+36	12,390
E-SHDB M 16	1SYE021616C0001 ■	16 way	8+48	13,120

#### IP 43 with metal door with acrylic

Product description	Ordering code	No. of ways	No. of modules	Unit MRP (₹)
E-SHDB P 4	1SYE021704C0001	4 way	8+12	7,330
E-SHDB P 6	1SYE021706C0001	6 way	8+18	8,520
E-SHDB P 8	1SYE021708C0001	8 way	8+24	9,630
E-SHDB P 12	1SYE021712C0001	12 way	8+36	14,770

#### IP 54

Product description	Ordering code	No. of ways	No. of modules	Unit MRP (₹)
E-SHDB M WP 4	1SYE021804C0001	4 way	8+12	16,030
E-SHDB M WP 6	1SYE021806C0001	6 way	8+18	19,300
E-SHDB M WP 8	1SYE021808C0001	8 way	8+24	21,100
E-SHDB M WP 12	1SYE021812C0001	12 way	8+36	29,740

■ Stock items

# Elegance series

## Distribution boards



### TPN DB E-SHPPI per phase isolation horizontal

Horizontal per-phase Isolation distribution board with provision for 8 pole (MCB / Isolator / RCD) as incomer and single phase as outgoing with separate neutral and earth bars for per phase isolation.

#### IP 43 with metal door

Product description	Ordering code	No. of ways	No. of modules	Unit MRP (₹)
E-SHPPI M 6	1SYE031606C0001 ■	6 way	8+18	11,060
E-SHPPI M 8	1SYE031608C0001 ■	8 way	8+24	12,960
E-SHPPI M 12	1SYE031612C0001 ■	12 way	8+36	16,940
E-SHPPI M 16	1SYE031616C0001 ■	16 way	8+48	20,200



### TPN DB E-SVDB per phase isolation vertical

Tier type per-phase isolation distribution board with provision for 8 pole (MCB / Isolator / RCD) incomer and provision for 2 pole (MCB / Isolator / RCD) as sub-incomers with single phase outgoing with separate neutral and earth bars for per phase Isolation.

#### IP 43 with metal door

Product description	Ordering code	No. of ways	No. of modules	Unit MRP (₹)
E-SVDB M 6	1SYE041606C0001 ■	6 way	8+6+18	12,560
E-SVDB M 8	1SYE041608C0001 ■	8 way	8+6+24	15,610
E-SVDB M 12	1SYE041612C0001 ■	12 way	8+6+36	18,330

# Elegance series

## Distribution boards



### VTPN DB vertical E-SVTDB 8P I/C & SP/TP O/G

Vertical three phase distribution board with provision for 8 pole (MCB / Isolator / RCD) incoming with three phase and single phase (TP/SP) outgoing, complete with insulated busbar arrangement.

#### IP 43 with metal door

Product description	Ordering code	No. of ways	No. of modules	Unit MRP (₹)
E-SVTDB M 4	1SYE061604C0001	4 way	8+12	14,270
E-SVTDB M 6	1SYE061606C0001	6 way	8+18	16,530
E-SVTDB M 8	1SYE061608C0001	8 way	8+24	17,910
E-SVTDB M 12	1SYE061612C0001	12 way	8+36	23,100



### VTPN DB vertical E-SVTDB-XT1 160A MCCB I/C & SP/TP MCB O/G

Vertical three phase distribution board with provision for 4 pole MCCB (Tmax - XT1) upto 160A as incomer with three phase and single.

#### IP 43 with metal door

Product description	Ordering code	No. of ways	No. of modules	Unit MRP (₹)
E-SVTDB M 4XT1	1SYE071604C0001	4 way	160A Tmax XT1+12	16,050
E-SVTDB M 6XT1	1SYE071606C0001	6 way	160A Tmax XT1+18	18,700
E-SVTDB M 8XT1	1SYE071608C0001	8 way	160A Tmax XT1+24	21,560
E-SVTDB M 12XT1	1SYE071612C0001	12 way	160A Tmax XT1+36	26,750



### VTPN DB vertical E-SVTDB-XT3 250 A MCCB I/C & SP/TP MCB O/G

Vertical three phase distribution board with provision for 4 pole MCCB (Tmax - XT3) upto 250A as incomer with three phase and single phase (TP/SP) outgoing, complete with insulated busbar arrangement.

#### IP 43 with metal door

Product description	Ordering code	No. of ways	No. of modules	Unit MRP (₹)
E-SVTDB M 4XT3	1SYE081604C0001	4 way	250A Tmax XT3+12	29,240
E-SVTDB M 6XT3	1SYE081606C0001	6 way	250A Tmax XT3+18	31,480
E-SVTDB M 8XT3	1SYE081608C0001	8 way	250A Tmax XT3+24	33,220
E-SVTDB M 12XT3	1SYE081612C0001	12 way	250A Tmax XT3+36	35,170



### 8 Segment DB - E-S8SEG - MCB I/C (Available also in RAL 9003 colour)

Eight segment distribution board with phase segregation and separation between incoming and outgoing with provision for 8P (MCB / Isolator / RCD) + 4P(ACCL provision) as incomer with single phase outgoing with complete wire sets.

#### IP 43 with metal door

Product description	Ordering code	No. of ways	No. of modules	Unit MRP (₹)
E-S8SEG M 4	1SYE051604C0001	4 way	8+12+12	14,440
E-S8SEG M 6	1SYE051606C0001	6 way	8+12+18	16,200
E-S8SEG M 8	1SYE051608C0001	8 way	8+12+24	18,030
E-S8SEG M 12	1SYE051612C0001	12 way	8+12+36	23,240
E-S8SEG M4 (RAL 9003)	1SYE151604C0001	4 way	8+12+12	Upon request
E-S8SEG M6 (RAL 9003)	1SYE151606C0001	6 way	8+12+18	
E-S8SEG M8 (RAL 9003)	1SYE151608C0001	8 way	8+12+24	
E-S8SEG M12 (RAL9003)	1SYE151612C0001	12 way	8+12+36	

# Elegance series

## Distribution boards



### Phase Selector DB - E-SPVS

Phase selector DBs-SPVS with inbuilt 3 nos. piano switches and 3 nos. phase selector switch of 63A.

#### IP 43 with metal door

Product description	Ordering code	No. of ways	No. of modules	Unit MRP (₹)
E-SPVS M 4(63A)	1SYE091604C0001	4 way	8+12	21,490
E-SPVS M 6(63A)	1SYE091606C0001	6 way	8+18	21,490
E-SPVS M 8(63A)	1SYE091608C0001	8 way	8+24	22,610
E-SPVS M 12(63A)	1SYE091612C0001	12 way	8+36	24,290



### Flexy tier DB - E-SVFL

Total flexibility as per site needs - configuration as per your choice of incomer & outgoings. Supply bus bars needs to be selected.

#### IP 43 with metal door

Product description	Ordering code	No. of ways	No. of modules	Unit MRP (₹)
E-SVFL M 132	1SYE101632C0001	2 row of 13mod	26	7,540
E-SVFL M 133	1SYE101633C0001 ■	3 row of 13mod	39	9,250
E-SVFL M 134	1SYE101634C0001 ■	4 row of 13mod	52	11,230
E-SVFL M 142	1SYE101642C0001	2 row of 14mod	28	8,110
E-SVFL M 143	1SYE101643C0001 ■	3 row of 14mod	42	9,340
E-SVFL M 144	1SYE101644C0001 ■	4 row of 14mod	56	11,930

### Plug & Socket DB - E-SGK

Plug socket boards for single phase and three phase applications up to 63A (supplied completely with plug and socket).

Product description	Ordering code	No. of ways	No. of modules	Unit MRP (₹)
E-SGK 20 SP	1SYE111520C0001 ■	20A SP	1	2,390
E-SGK 30 TP	1SYE111530C0001 ■	30A TP	3	5,100
E-SGK 60 FP	1SYE111560C0001 ■	60A FP	4	19,200

### Enclosure - E-SEN

Metal enclosures, universal mounting suitable for 1M, 2M, 3M, 4M, 6M and 8M arrangement.

Product description	Ordering code	No. of ways	No. of modules	Unit MRP (₹)
E-SEN 2P	1SYE121502C0001 ■	2P Enclosure	2	930
E-SEN 4P	1SYE121504C0001 ■	4P Enclosure	4	930
E-SEN 6P	1SYE121506C0001 ■	6P Enclosure	6	1,280
E-SEN 8P	1SYE121508C0001 ■	8P Enclosure	8	1,520



### Busbar SP I/C & SP O/G

Product description	Ordering code	No. of ways	No. of modules	Unit MRP (₹)
13Mod Insulated Busbars	1SYE131514C0001 ■	13	13	530
14Mod Insulated Busbars	1SYE131500C0001 ■	14	14	530

### Blanking plate

Product description	Ordering code	No. of ways	No. of modules	Unit MRP (₹)
Blank PL	1SYE131513C0001 ■		1	27

■ Stock items

# Elegance series

## Distribution boards

### Cable and box

Product description	Ordering code	No. of ways	Unit MRP (₹)
<b>SPN IP43 SHC</b>			
E-SHC M 4/CEB	1SYE140104C0001	For 4 way SPN IP43 DB	800
E-SHC M 6/CEB	1SYE140106C0001	For 6 way SPN IP43 DB	840
E-SHC M 8/CEB	1SYE140108C0001	For 8 way SPN IP43 DB	980
E-SHC M 10/CEB	1SYE140110C0001	For 10 way SPN IP43 DB	940
E-SHC M 12/CEB	1SYE140112C0001	For 12 way SPN IP43 DB	1,120
E-SHC M 14/CEB	1SYE140114C0001	For 14 way SPN IP43 DB	1,100
E-SHC M 16/CEB	1SYE140116C0001	For 16 way SPN IP43 DB	1,260
E-SHC M 20/CEB	1SYE140120C0001	For 20 way SPN IP43 DB	1,400
<b>TPN IP43 SHDB</b>			
E-SHDB M 4/CEB	1SYE140204C0001	For 4 way TPN IP43 DB	1,400
E-SHDB M 6/CEB	1SYE140206C0001	For 6 way TPN IP43 DB	1,480
E-SHDB M 8/CEB	1SYE140208C0001	For 8 way TPN IP43 DB	1,840
E-SHDB M 12/CEB	1SYE140212C0001	For 12 way TPN IP43 DB	2,320
<b>TPN IP43 SHPPI</b>			
E-SHPPI M 6/CEB	1SYE140306C0001	For 6way PPI IP43 DB	1,680
E-SHPPI M 8/CEB	1SYE140308C0001	For 8way PPI IP43 DB	2,300
E-SHPPI M 12/CEB	1SYE140312C0001	For 12way PPI IP43 DB	3,310
<b>TPN IP43 SVDB</b>			
E-SVDB M 6/CEB	1SYE140406C0001	For 6way SVDB IP43 DB	1,460
E-SVDB M 8/CEB	1SYE140408C0001	For 8way SVDB IP43 DB	1,740
E-SVDB M 12/CEB	1SYE140412C0001	For 12way SVDB IP43 DB	2,010
<b>Flexy DB IP43</b>			
E-SVFL 13M/CEB	1SYE140508C0001	For all SVFL 13Mod DBs	1,830
E-SVFL 14M/CEB	1SYE140512C0001	For all SVFL 14Mod DBs	2,220
<b>VTPN IP43 SVTDB</b>			
E-SVTDB M/CEB	1SYE140800C0001	For all SVTDBs(IP43DBs)	3,370
<b>VTPN IP43 XT1 160A</b>			
E-SVTDB M XT1/CEB	1SYE140504C0001	For all SVTDB XT1 DBs(IP43DBs)	4,380
<b>VTPN IP43 XT3 250A</b>			
E-SVTDB MXT3CEB	1SYE140506C0001	For all SVTDB XT3 DBs(IP43DBs)	5,190
<b>8 Segment</b>			
E-S8SEG M4/CEB	1SYE14013C0001	For 4 way 8 Segment DB	2,620
E-S8SEG M6/CEB	1SYE14014C0001	For 6 way 8 Segment DB	3,070
E-S8SEG M8/CEB	1SYE140600C001	For 8 way 8 Segment DB	3,570
E-S8SEG M12/CEB	1SYE140700C001	For 12 way 8 Segment DB	4,390

# Classic series

## Distribution boards



### SPN DB - SHC

#### IP 30



Product description	No. of ways	No. of modules	Ordering code	Unit MRP (₹)
SHC WD 4	4 way	4+2	1SYN869006R0001 ■	1,650
SHC WD 6	6 way	6+2	1SYN869007R0001	1,700
SHC WD 8	8 way	8+2	1SYN869008R0001 ■	2,050
SHC WD 10	10 way	10+2	1SYN869006R0010	2,230
SHC WD 12	12 way	12+2	1SYN869009R0001 ■	2,640
SHC WD 14	14 way	14+2	1SYN869010R0001	2,720
SHC WD 16	16 way	16+2	1SYN869006R0016 ■	3,360
SHC WD 20	20 way	20+2	1SYN869006R0020	3,970

#### IP 43 with metal door



Product description	No. of ways	No. of modules	Ordering code	Unit MRP (₹)
SHC M 4	4 way	4+2	1SYN869001R0001 ■	2,330
SHC M 6	6 way	6+2	1SYN869002R0001 ■	2,570
SHC M 8	8 way	8+2	1SYN869003R0001	3,030
SHC M 10	10 way	10+2	1SYN869004R0101	3,140
SHC M 12	12 way	12+2	1SYN869004R0001 ■	3,480
SHC M 14	14 way	14+2	1SYN869005R0001	4,050
SHC M 16	16 way	16+2	1SYN869001R0016 ■	4,210
SHC M 20	20 way	20+2	1SYN869001R0020	4,800

Classic series distribution boards are available in ivory color (color code - RAL9010)

■ Stock items

# Classic series

## Distribution boards



### SPN DB - SHC

#### IP 43 metal door with acrylic

Product description	No. of ways	No. of modules	Ordering code	Unit MRP (₹)
SHC P 4	4 way	4+2	1SYN869011R0041	2,530
SHC P 6	6 way	6+2	1SYN869011R0042	2,880
SHC P 8	8 way	8+2	1SYN869013R0001	3,310
SHC P 10	10 way	10+2	1SYN869013R0002	3,740
SHC P 12	12 way	12+2	1SYN869015R0012	4,000
SHC P 14	14 way	14+2	1SYN869015R0001	4,510
SHC P 16	16 way	16+2	1SYN869011R0161	4,860
SHC P 20	20 way	20+2	1SYN869011R0201	5,530



### IP 54

Product description	No. of ways	No. of modules	Ordering code	Unit MRP (₹)
SHC M WP 4	4 way	4+2	1SYN869002R0004	6,420
SHC M WP 6	6 way	6+2	1SYN869004R0020	6,790
SHC M WP 8	8 way	8+2	1SYN869002R0008	8,500
SHC M WP 10	10 way	10+2	1SYN869004R0021	8,740
SHC M WP 12	12 way	12+2	1SYN869002R0012	8,850
SHC M WP 14	14 way	14+2	1SYN869004R0022	9,360
SHC M WP 16	16 way	16+2	1SYN869004R0023	10,810
SHC M WP 20	20 way	20+2	1SYN869002R0013	11,060



### TPN DB - SHDB horizontal

#### IP 30

Product description	No. of ways	No. of modules	Ordering code	Unit MRP (₹)
SHDB WD 4	4 way	8+12	1SYN869020R0001 ■	4,230
SHDB WD 6	6 way	8+18	1SYN869021R0001	4,950
SHDB WD 8	8 way	8+24	1SYN869022R0001 ■	5,890
SHDB WD 12	12 way	8+36	1SYN869023R0001 ■	9,070



### IP 43 with metal door

Product description	No. of ways	No. of modules	Ordering code	Unit MRP (₹)
SHDB M 4	4 way	8+12	1SYN869016R0001 ■	5,350
SHDB M 6	6 way	8+18	1SYN869017R0001	6,310
SHDB M 8	8 way	8+24	1SYN869018R0001 ■	7,750
SHDB M 12	12 way	8+36	1SYN869019R0001 ■	11,250
SHDB M 16	16 way	8+48	1SYN869004R0025 ■	14,110



### IP 43 metal door with acrylic

Product description	No. of ways	No. of modules	Ordering code	Unit MRP (₹)
SHDB P 4	4 way	8+12	1SYN869024R0001	5,990
SHDB P 6	6 way	8+18	1SYN869025R0001	7,440
SHDB P 8	8 way	8+24	1SYN869026R0001	8,440
SHDB P 12	12 way	8+36	1SYN869027R0006	11,780



### IP 54

Product description	No. of ways	No. of modules	Ordering code	Unit MRP (₹)
SHDB M WP 4	4 way	8+12	1SYN869001R0004	14,160
SHDB M WP 6	6 way	8+18	1SYN869001R0006	17,050
SHDB M WP 8	8 way	8+24	1SYN869001R0008	18,660
SHDB M WP 12	12 way	8+36	1SYN869004R0027	26,450

■ Stock items



# Classic series

## Distribution boards



### TPN DB SHPPI per phase isolation horizontal

#### IP 43 WITH METAL DOOR

Product description	No. of ways	No. of modules	Ordering code	Unit MRP (₹)
SHPPI M 6	6 way	8+18	1SYN8690100R0061	8,860
SHPPI M 8	8 way	8+24	1SYN8690100R0081	10,600
SHPPI M 12	12 way	8+36	1SYN8690100R0121	14,150
SHPPI M 16	16 way	8+48	1SYN8690100R0161	17,220



### TPN DB SVDB per phase isolation vertical

#### IP 43 WITH METAL DOOR

Product description	No. of ways	No. of modules	Ordering code	Unit MRP (₹)
SVDB M 6	6 way	8+6+18	1SYN869028R0001	11,340
SVDB M 8	8 way	8+6+24	1SYN869029R0001	13,370
SVDB M 12	12 way	8+6+36	1SYN869030R0001	15,440



### VTPN DB vertical E-SVTDB 8P I/C & SP/TP O/G

#### IP 43 WITH METAL DOOR

Product description	No. of ways	No. of modules	Ordering code	Unit MRP (₹)
SVTDB M 4	4 way	8+12	1SYN869031R0001	12,780
SVTDB M 6	6 way	8+18	1SYN869032R0001	15,050
SVTDB M 8	8 way	8+24	1SYN869033R0001	17,080
SVTDB M 12	12 way	8+36	1SYN869034R0001	21,650



### VTPN DB vertical SVTDB-XT1 160A MCCB I/C & SP/TP MCB O/G

#### IP 43 WITH METAL DOOR

Product description	No. of ways	No. of modules	Ordering code	Unit MRP (₹)
SVTDB M 4XT1	4 way	160A Tmax XT1+12	1SYN8690VMXT104	14,990
SVTDB M 6XT1	6 way	160A Tmax XT1+18	1SYN8690VMXT106	17,150
SVTDB M 8XT1	8 way	160A Tmax XT1+24	1SYN8690VMXT108	18,450
SVTDB M 12XT1	12 way	160A Tmax XT1+36	1SYN8690VMXT112	23,690



### VTPN DB vertical SVTDB-XT3 250A MCCB I/C & SP/TP MCB O/G

#### IP 43 WITH METAL DOOR

Product description	No. of ways	No. of modules	Ordering code	Unit MRP (₹)
SVTDB M 4XT3	4 way	250A Tmax XT3+12	1SYN8690VMXT304	25,920
SVTDB M 6XT3	6 way	250A Tmax XT3+18	1SYN8690VMXT306	28,500
SVTDB M 8XT3	8 way	250A Tmax XT3+24	1SYN8690VMXT308	30,890
SVTDB M 12XT3	12 way	250A Tmax XT3+36	1SYN8690VMXT312	31,560

# Classic series

## Distribution boards

### 7 SEGMENT DB - S7SEG

#### IP43 WITH METAL DOOR



Product description	No. of ways	No. of modules	Ordering code	Unit MRP (₹)
S7SEG M 4	4 way	8+12+12	1SYN869058R0001	13,900
S7SEG M 6	6 way	8+12+18	1SYN869059R0001	15,630
S7SEG M 8	8 way	8+12+24	1SYN869060R0001	16,930
S7SEG M 12	12 way	8+12+36	1SYN869061R0001	19,940

### PHASE SELECTOR DB - SPVS

#### IP43 WITH METAL DOOR



Product description	No. of ways	No. of modules	Ordering code	Unit MRP (₹)
SPVS M 4(63A)	4 way	8+12	1SYN869100R0001	20,190
SPVS M 6(63A)	6 way	8+18	1SYN869100R0002	21,050
SPVS M 8(63A)	8 way	8+24	1SYN869100R0003	21,650
SPVS M 12(63A)	12 way	8+36	1SYN869100R0004	24,080

### FLEXY TIER DB - SVFL

#### IP43 WITH METAL DOOR



Product description	No. of ways	No. of modules	Ordering code	Unit MRP (₹)
SVFL M 132	2 row of 13mod	26	1SYN869004R0051	6,220
SVFL M 133	3 row of 13mod	39	1SYN869103R0001	7,570
SVFL M 134	4 row of 13mod	52	1SYN869103R0002	9,960
SVFL M 142	2 row of 14mod	28	1SYN869004R0052	7,170
SVFL M 143	3 row of 14mod	42	1SYN869004R0053	8,690
SVFL M 144	4 row of 14mod	56	1SYN869103R0012	10,090

### Plug & Socket DB - SGK

Product description	No. of ways	No. of modules	Ordering code	Unit MRP (₹)
SGK 20 SP	20A SP	1	1SYN869043R0001 ■	2,050
SGK 30 TP	30A TP	3	1SYN869044R0001 ■	4,960
SGK 60 FP	60A FP	4	1SYN869053R0001 ■	18,870



### Enclosure - SEN

Product description	No. of ways	No. of modules	Ordering code	Unit MRP (₹)
SEN 2P	2P Enclosure	2	1SYN869055R0001 ■	840
SEN 4P	4P Enclosure	4	1SYN869056R0001 ■	860
SEN 6P	6P Enclosure	6	1SYN869057R0001 ■	1,200
SEN 8P	8P Enclosure	8	1SYN869004R0029 ■	1,380



### BUSBAR SP I/C & SP O/G, BLANKING PLATE

Product description	No. of ways	No. of modules	Ordering code	Unit MRP (₹)
13 Module Pin type Busbars	13	13	1SYN360025P0001 ■	510
14 Module Pin type Busbars	14	14	1SYN869103R0013 ■	510

### BLANKING PLATE

Product description	No. of ways	No. of modules	Ordering code	Unit MRP (₹)
Blank PL		1	1SYN869004R0059 ■	27

# Classic series

## Distribution boards

### One way MCCB enclosures

#### XT1 MCCB ENCL

Product description	No. of ways	Ordering code	Unit MRP (₹)
XT1 TP MCCB Enclosure	3 pole	1SYT121503C0001	2,140
XT1 FP MCCB Enclosure	4 pole	1SYT121504C0001	2,440

#### XT3 MCCB ENCL

Product description	No. of ways	Ordering code	Unit MRP (₹)
XT3 TP MCCB Enclosure	3 pole	1SYT321503C0001	2,440
XT3 FP MCCB Enclosure	4 pole	1SYT321504C0001	2,730

#### A1 MCCB ENCL

Product description	No. of ways	Ordering code	Unit MRP (₹)
A1 TP MCCB Enclosure	3 pole	1SYA121503C0001	2,440
A1 FP MCCB Enclosure	4 pole	1SYA121504C0001	2,590

#### A2 MCCB ENCL

Product description	No. of ways	Ordering code	Unit MRP (₹)
A2 TP MCCB Enclosure	3 pole	1SYA221503C0001	2,590
A2 FP MCCB Enclosure	4 pole	1SYA221504C0001	2,660

# Classic series

## Distribution boards

### Cable end box

Product description	Ordering code	No. of ways	Unit MRP (₹)
<b>SPN IP43 SHC</b>			
SHC M 4/CEB	1SYN869103R0014	For 4 way SPN IP 43 DB	730
SHC M 6/CEB	1SYN869103R0015	For 6 way SPN IP43 DB	800
SHC M 8/CEB	1SYN869004R0082	For 8 way SPN IP43 DB	820
SHC M 10/CEB	1SYN869004R0083	For 10 way SPN IP43 DB	870
SHC M 12/CEB	1SYN869004R0084	For 12 way SPN IP43 DB	980
SHC M 14/CEB	1SYN869004R0085	For 14 way SPN IP43 DB	1,080
SHC M 16/CEB	1SYN869004R0086	For 16 way SPN IP43 DB	1,310
SHC M 20/CEB	1SYN869004R0087	For 20 way TPN IP43 DB	1,630
<b>TPN IP43 SHDB</b>			
SHDB M 4/CEB	1SYN869004R0088	For 4 way TPN IP43 DB	1,230
SHDB M 6/CEB	1SYN869004R0089	For 6 way TPN IP43 DB	1,260
SHDB M 8/CEB	1SYN869004R0090	For 8 way TPN IP43 DB	1,850
SHDB M 12/CEB	1SYN869004R0091	For 12 way TPN IP43 DB	2,040
<b>TPN IP43 SHPPI</b>			
SHPPI M 6/CEB	1SYN869004R0093	For 6 way PPI IP43 DB	1,420
SHPPI M 8/CEB	1SYN869004R0094	For 8 way PPI IP43 DB	1,960
SHPPI M 12/CEB	1SYN869004R0095	For 12 way PPI IP43 DB	2,800
SHPPI M 16/CEB	1SYN869004R0096	For 16 way PPI IP43 DB	3,040
<b>TPN IP43 SVDB</b>			
SVDB M 6/CEB	1SYN869004R0097	For 6 way SVDB IP43 DB	1,510
SVDB M 8/CEB	1SYN869004R0098	For 8 way SVDB IP43 DB	1,530
SVDB M 12/CEB	1SYN869004R0099	For 12 way SVDB IP43 DB	1,770
<b>Flexy DB IP43</b>			
SVFL 13M/CEB	1SYN869004R0103	For all SVFL 13Mod DBs	1,620
SVFL 14M/CEB	1SYN869004R0104	For all SVFL 14Mod DBs	1,970
<b>VTPN IP43 SVTDB</b>			
SVTDB M/CEB	1SYN869004R0100	For all SVTDBs(IP43DBs)	3,010
<b>VTPN IP43 XT1 160A</b>			
SVTDB M XT1 160/CEB	1SYN869004C0101	For all SVTDB XT1 160 DBs(IP43DBs)	3,810
<b>VTPN IP43 XT3 250A</b>			
SVTDB M XT3 250/CEB	1SYN869004C0103	For all SVTDB XT3 250 DBs(IP43DBs)	4,470
<b>7 Segment CB</b>			
S7SEG M4/CEB	1SYN141013C0001	For 4 way 7 SEG IP43 DB	2,300
S7SEG M6/CEB	1SYN141014C0001	For 6 way 7 SEG IP43 DB	2,690
S7SEG M8/CEB	1SYN140600C0001	For 8 way 7 SEG IP43 DB	3,130
S7SEG M12/CEB	1SYN140700C0001	For 12 way 7 SEG IP43 DB	3,850

## Complete range

Customization in ABB Distribution Enclosures available on request\*

- i) Enclosures-TV/TEL/IOT related backend devices
- ii) Enclosures-SPD provision
- iii) Pre-wired distribution boards
- iv) Indication lamps provision
- v) MCCB enclosures

# Mistral IP 65 enclosures

## A point of reference. For simplicity and effectiveness

### A complete series, versatile and easy to install

Efficiency, safety, integration: the new System pro E comfort MISTRAL65 series rests on the strengths which have consolidated ABB's image over the years for its expertise and reliability in the area of products for protection, control, monitoring, measurement, safety and energy efficiency. These innovative IP65 rated consumer units complete

ABB's wide product range for the industrial sector. The result of constant research and constant attention paid to technological development, the System pro E comfort consumer units are designed to satisfy all requirements electrical installers might have.



Description	No. modules	No. of rows	Dimensions WxHxD	Order code	L.P. (₹)
Mistral65 transparent door 4M	4	1	52x202x117	1SL1200A00	3,520
Mistral65 transparent door 8M	8	1	232x250x154	1SL1201A00	5,690
Mistral65 transparent door 12M	12	1	320x250x155	1SL1202A00	7,570
Mistral65 transparent door 18M	18	1	430x250x155	1SL1203A00	9,600
Mistral65 transparent door 24M	24	2	320x435x155	1SL1204A00	11,760
Mistral65 transparent door 36M 2F	36	2	430x435x155	1SL1205A00	18,730
Mistral65 transparent door 36M 3F	36	3	320x600x155	1SL1206A00	18,730
Mistral65 transparent door 54M	54	3	430x600x155	1SL1208A00	27,020

# ABB Gemini

## Switchboards

ABB SACE's Gemini range is revolutionizing the market of low voltage electric insulating switchboards. The reason for this is that it is the first switchboard made in thermoplastic material, to which the co-injection molding technique gives the same mechanical characteristics as polyester. This means that it is extremely sturdy, with its rigid covering and expanded internal

core. Moreover, it contains no fiber glass, a material that with time rises to the surface, jeopardizing the functioning and safety of switchboards made in polyester with which it is usually mixed. Available in 6 different sizes with transparent or opaque door, the Gemini switchboards are suitable for installation in any application context.



Compliance with standard	IEC60670, EN 50298, 60439-1, 62208, 61439 – 1 & 2
Rated service voltage	1000V AC
Degree of protection	IP 30 open door / IP66 closed door

\* Details available on request

# Millenium

Thanks to a combined system, the switches of the Millenium series provide a comprehensive range of solutions for single rooms or whole building concepts. The square and ultra slim switches do not only add quality and style to the overall building, but are also easy to install.

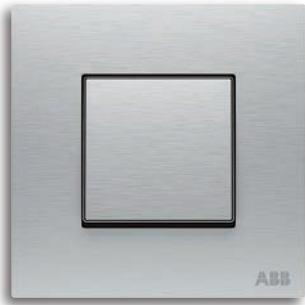

— Stainless Steel

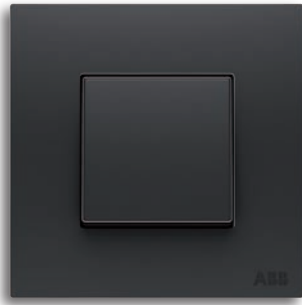

— Silk Black \*



— Stainless Steel and Silk Black



— White Glass \*\*

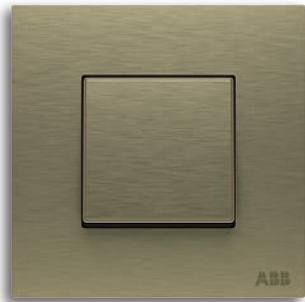

— Antique Gold

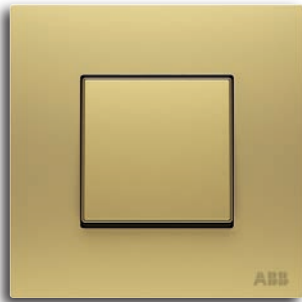

— Matt Gold



— Matt Gold and Silk Black



— Black Glass \*\*

\* Silk Black not suitable to installation outdoors  
\*\* Cover frame made of real glass



# Millenium

Millenium gives answer to the future by providing comfort, safety, and energy saving.



- Modern and contemporary 4 finishes
- Real stainless steel material **AISI 304**
- 2 finishes made in **CSG glass**
- Slim line design only **4 mm**
- Rocker with attractive **chrome profile**
- Designed by the famous European designer **Josep LLusca**



Millenium and Zenit assembled by ABB's YuMi® robot at ABB Bengaluru.

## ABB-free@home® with Millenium range



Switch 2/4gang, Stainless Steel

- Blind
- Light
- Heating
- Air conditioning
- Door communication

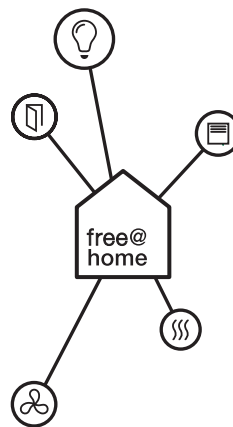

**Bureau of Indian Standards**



Millenium range has been designed following the requirements of norm ISO 14006 Environmental management systems / guidelines for incorporating Ecodesign certificate.

Switches as per BIS standards and with ISI marking.

Now scan the QR code to find out more about the advantages of ABB-free@home® [abb.com/freathome](http://abb.com/freathome)



## Zenit

### The highlight of modular series

Zenit is the most comprehensive modular range for all kind of homes and commercial buildings. A number of appreciated designs and beautiful finishes that add value to the facility, with advanced features that provide greater comfort and performance level. With Zenit you can make any type of installation, can enjoy benefit of technical advantages that make it easier and faster. This range has the guarantee of a brand renowned for its quality such as ABB.

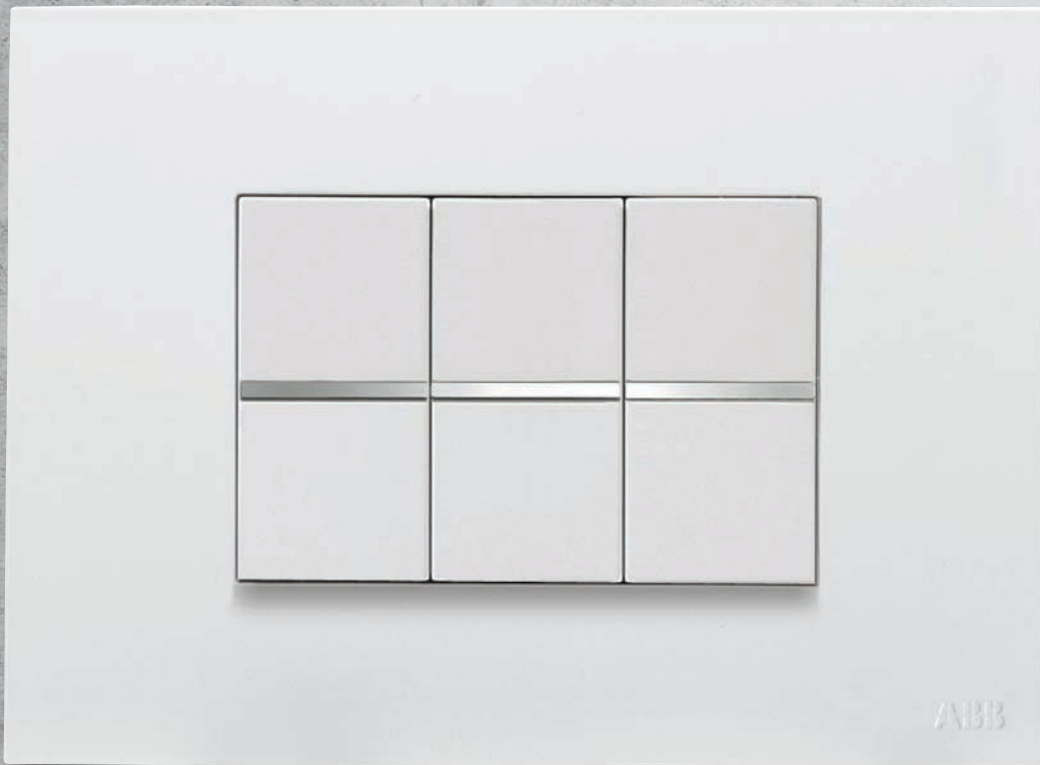

BL



PL



CB



CN



CC



OX



**Zenit**

- BL White
- PL Silver
- AN Anthracite
- CV Champagne

**Zenit Noble**

- CB White Glass
- CN Black Glass
- CF Graphite Glass
- CH Champagne Glass
- CP Pearl Glass

- CC Coffee Glass
- OX Stainless Steel
- WG Wenge
- PZ Slate

AN

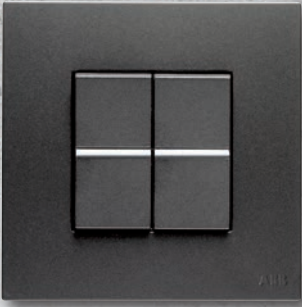

CV



CP



CF



CH



WG



PZ



# Wiring accessories

## IVIE

### Switch to the future

IVIE is the latest premium modular range of wiring accessories designed to address various functionalities. These include basic switching, controlling, comfort and energy saving.

The IVIE range innovatively matches your interiors and aesthetically brings out the best in your comfort zone. The enhanced design for reliable performance of this range is for the passionate, compassionate, intuitive and magnetic personality within each one of us.

The IVIE range, includes the tastefully selected color options, caters to the needs of various segments like residential, commercial and hospitality.

IVIE with its ability to integrate home automation solutions in your existing switch box, makes the range future proof.

IVIE truly makes you want to switch to the future.

### Sleek and convex design in different finishes

Thanks to the complete system, The IVIE series provides a comprehensive range of solutions for building concepts. The convex and sleek design not only provides quality and style to the overall building, but is easy to install.



01

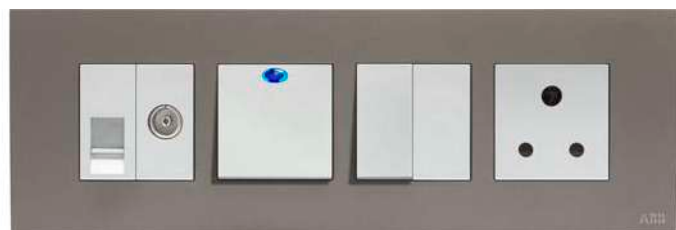

02



03



04

Different finishes and combinations:

- 01 Anthracite grey mechanisms in Silver plate
- 02 Silver mechanisms in Anthracite Grey plate
- 03 Anthracite grey mechanisms in White plate
- 04 Anthracite grey mechanisms in Anthracite Grey plate

## Flexibility in design which provides total control

The IVIE range is the first Indian range to incorporate wired and wireless home automation systems together. This range can be integrated with

ABB-free@home® home automation system, which is the most intelligent way of managing spaces with energy saving.

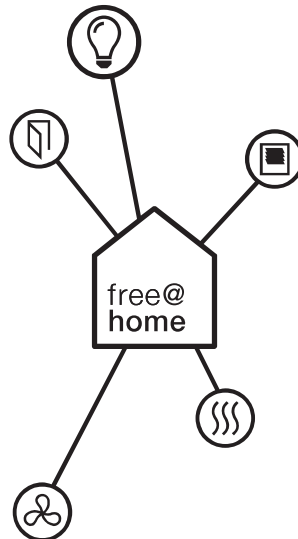

Great comfort, safety and energy efficiency for buildings

ABB-free@home® sensor for switching control, blind control, dimming and scene control.



# IVIE complete range

## IVIE mechanisms - White



1SYK100001A1001

Type reference and description	Number of modules	Std pack	Ordering code	Unit M.R.P.(₹)
<b>Switch 6 A - 240 V ~</b>				
IIS10610 BL - 6A 1 way switch	1	20/400	1SYK100001A1001 ■	168
IIS10620 BL - 6A 2 way switch	1	20/400	1SYK100001A1002 ■	320



1SYK100001A1009

Type reference and description	Number of modules	Std pack	Ordering code	Unit M.R.P.(₹)
<b>Switch 10 A - 240 V ~</b>				
IIS11010 BL 10A 1 way switch	1	20/400	1SYK100001A1009 ■	183
IIS1101L BL 10A 1 way switch with indicator	1	20/400	1SYK100001A1012 ■	247
IIS11020 BL 10A 2 way switch	1	20/400	1SYK100001A1010	335



1SYK100001A1007

Type reference and description	Number of modules	Std pack	Ordering code	Unit M.R.P.(₹)
<b>Switch 16 A - 240 V ~</b>				
IIS11610 BL - 16A 1 way switch	1	20/400	1SYK100001A1006 ■	404
IIS1161L BL - 16A 1 way switch with indicator	1	20/400	1SYK100001A1007 ■	483



1SYK100001A1008

Type reference and description	Number of modules	Std pack	Ordering code	Unit M.R.P.(₹)
<b>Switch 32 A - 240 V ~</b>				
IIS2321L BL - 32A, DP switch	2	10/200	1SYK100001A1008 ■	1,351



1SYK100001A1003



1SYK100001A1005

Type reference and description	Number of modules	Std pack	Ordering code	Unit M.R.P.(₹)
<b>Bell Push</b>				
IIS106B0 BL - 6A Bell switch	1	20/400	1SYK100001A1003 ■	355
IIS106BL BL - 6A Bell switch with indicator	1	20/400	1SYK100001A1004 ■	449
IIS206BL BL - 6A Mega Bell switch with indicator	2	10/200	1SYK100001A1005 ■	626



1SYK100001A1023



1SYK100001A1028

Type reference and description	Number of modules	Std pack	Ordering code	Unit M.R.P.(₹)
<b>Sockets</b>				
IIK20306 BL 6A 3Pin Socket	2	10	1SYK100001A1028 ■	426
IIK20616 BL - 6/16A socket	2	10/200	1SYK100001A1023 ■	626



1SYK100001A1060



1SYK100001A1061

Type reference and description	Number of modules	Std pack	Ordering code	Unit M.R.P.(₹)
<b>USB chargers</b>				
IIM1USBC BL 2A 1M USB Charger	1	1	1SYK100001A1060 ■	1,943
IIM2USBC BL 3A 2M USB Charger	2	1	1SYK100001A1061	2,940



1SYK100001A1041

Type reference and description	Number of modules	Std pack	Ordering code	Unit M.R.P.(₹)
<b>Blank plates</b>				
IIM1BLNK BL - blank plate	1	20/400	1SYK100001A1041 ■	81

■ Stock items

# IVIE complete range

## IVIE mechanisms - White



1SYK100001A1042



1SYK100001A1045



2CLA226020N1101



2CLA226030N1101



2CLA226080N1101



2CLA226090N1101



1SYK100001A1047



1SYK100001A1049



1SYK100001A1051

Type reference and description	Number of modules	Std pack	Ordering code	Unit M.R.P.(₹)
<b>Dimmer &amp; fan regulators</b>				
IIM2FR05 BL - step fan regulator 5 step	2	5/100	1SYK100001A1042 ■	1,346
IIM1FR04 BL - step fan regulator 4 step	1	10/200	1SYK100001A1043 ■	1,169
IIM2D400 BL - dimmer 400 watt	1	10/200	1SYK100001A1045	1,593
N2260.2 BL - Universal rotatory/push dimmer, 230V • Rated voltage: 230 V AC • Max. power: incandescent: 500 Watt halogen lamp with electronic transformer: 500 VA • Halogen lamp with ferromagnetic transformer: 400 VA	2	1	2CLA226020N1101	48,002
N2260.3 BL - LED rotatory/push dimmer, 230V • Rated voltage: 230 V AC • Nominal power: 250 W/VA Power (min./max load): LEDi: 2/100 W/VA (max. 10 lamps) • Dimmable energy saving lamps: 2/100 W/VA (max. 10 lamps) • LV LEDi with transformer (only type L or LC): 4/100 W/VA (max. 10 lamps) • Incandescent lamps: 10/250 W/VA • Halogen lamps: 10/250 W/VA • LV halogen with transformer (only type L or LC): 10/250 W/VA (max. 10 lamps) • 2 wire connection. Optional: auxiliary on/off with 2-way switch N2X02	2	1	2CLA226030N1101	21,820
N2260.8 BL - LED rotatory/push dimmer • Rated voltage: 127 V AC, Frequency: 50/60 Hz (Nominal power: 140 W/VA) • Power (min./max load): LEDi: 2/55 W/VA (max. 10 lamps) • Dimmable energy saving lamps: 2/55 W/VA (max. 10 lamps) • LV LEDi with transformer (only type L or LC): 4/55 W/VA (max. 10 lamps) • Incandescent lamps: 10/140 W/VA • Halogen lamps: 10/140 W/VA • LV halogen with transformer (only type L or LC): 10/140 W/VA (max. 10 lamps)	2	1	2CLA226080N1101	23,906
N2260.9 BL - 1-10V rotary dimmer • Rated voltage: 127 - 230 V AC/50 - 60 Hz • Max. power: 230 Vac: 700 VA • 127 V AC: 350 VA • Max. 6 ballasts per device	2	1	2CLA226090N1101	16,127

Type reference and description	Number of modules	Std pack	Ordering code	Unit M.R.P.(₹)
<b>Data &amp; voice</b>				
IIM1RJ11 BL - RJ11 Tel. jack 2 pin	1	20/400	1SYK100001A1047 ■	314
IIM1RJ45 BL - RJ45 Jack cat 6	1	20/400	1SYK100001A1048 ■	1,157

Type reference and description	Number of modules	Std Pack	Ordering code	Unit M.R.P.(₹)
<b>TV Socket</b>				
IIM1TVSK BL - TV co-axial socket	1	20/400	1SYK100001A1049 ■	319

Type reference and description	Number of modules	Std Pack	Ordering code	Unit M.R.P.(₹)
<b>Starters</b>				
IIM2ST20 BL - Single Phase Starter 20A	2	5/100	1SYK100001A1051	1,361
IIM2ST25 BL - Single Phase Starter 25A	2	5/100	1SYK100001A1052	1,476

■ Stock items

# IVIE complete range

## IVIE mechanisms - White



1SYK100001A1055



2CLA224450N1102 2CLA218050N1101  
2CLA218040N1101



2CLA221410N1101



1SYK100001A1059



2CLA215520N1102 2CLA215530N1102



2CLA215540N1102 2CLA215560N1102



2CLA224100N1101



2CLA222400N1101



2CLA211900N1102 2CLA221900N1101



1SYK100001A1053

■ Stock items

Type reference and description	Number of modules	Std pack	Ordering code	Unit M.R.P.(₹)
<b>DND &amp; MMR</b>				
IIM1DND5 BL - DND and MMR set internal & external	2+3	5/100	1SYK100001A1055	2,193
N2244.5 BL - DND and MUR 2-gang interlocked switch	2	5	2CLA224450N1101	
N2180.5 BL - LED MUR signaling light	1	5	2CLA218050N1101	7,141
N2180.4 BL - LED DND signaling light	1	5	2CLA218040N1101	

Type reference and description	Number of modules	Std pack	Ordering code	Unit M.R.P.(₹)
<b>Key card switches</b>				
N2214.1 BL - Card switch 1-gang, 1-way, DP	2	1	2CLA221410N1101	6,796

Type reference and description	Number of modules	Std pack	Ordering code	Unit M.R.P.(₹)
<b>Down lighter</b>				
IIM3DOWN BL-down lighter	3	5/100	1SYK100001A1059 ■	1,043

Type reference and description	Number of modules	Std pack	Ordering code	Unit M.R.P.(₹)
<b>Audio &amp; video connector</b>				
N2155.2 BL - 2x RCA connection unit	1	1	2CLA215520N1101	5,000
N2155.3 BL - 3x RCA connection unit	1	1	2CLA215530N1101	6,173
N2155.4 BL - Mini-Jack connection unit	1	1	2CLA215540N1101	5,000
N2155.5 BL - VGA connection unit	1	1	2CLA215550N1101	5,781
N2155.6 BL - HDMI connection unit	1	1	2CLA215560N1101	6,740
N2155.7 BL - HDMI female-female connection unit	1	1	2CLA215570N1101	6,740
N2155.8 BL - USB connection unit	1	1	2CLA215580N1101	5,000
N2155.9 BL - USB female-female connection unit	1	1	2CLA215590N1101	5,000

Type reference and description	Number of modules	Std pack	Ordering code	Unit M.R.P.(₹)
<b>Motion sensor</b>				
N2241 BL - 110° motion sensor • Max. power: Incandescent: 1,800W @230V AC/1,000W @127V AC • Halogen with electronic or ferromagnetic transformer: 750VA @230V AC/400VA @127V AC - Fluorescent lamps or motors: 400VA @230V AC/200VA @127V AC • For automatic switching of devices dependent on motion and brightness • With integrated selector switch for automatic ON-OFF in the front side • Switch-off delay: 10 sec to 10 min or short-time pulse 1 sec adjustable (from the front side) • Detection range: 5 m radius • Adjustable light set point level for activation (from the front side) • Detection angle: 110° Mounting height: 1, 2 m Auxiliary control with N2X04.X push-buttons	2	1	2CLA224100N1101	24,861

Type reference and description	Number of modules	Std pack	Ordering code	Unit M.R.P.(₹)
<b>Buzzer &amp; door bell</b>				
IIM2BUZR BL - Buzzer	2	5/100	1SYK100001A1054	722
N2119 BL - Buzzer	1	1	2CLA211900N1101	3,208
N2219 BL - Buzzer	2	1	2CLA221900N1101	3,518
N2224 BL - Electronic door bell 230 V AC	2	1	2CLA222400N1101	14,284

Type reference and description	Number of modules	Std pack	Ordering code	Unit M.R.P.(₹)
<b>Indicator</b>				
IIM1INDI BL - Indicator	1	20/400	1SYK100001A1053	485



# IVIE complete range

## IVIE mechanisms - White



2CLA218000N1601

Type reference and description	Number of modules	Std pack	Ordering code	Unit M.R.P.(₹)
<b>Signaling light</b>				
N2180 BL - L ED white signaling light, Lamp: white LED Luminous flux: > 2 lumen at 1 meter, white diffuser	1	5	2CLA218000N1101	5,714
N2180 RJ - LED red signaling light, Lamp: white LED Luminous flux: > 2 lumen at 1 meter, Red diffuser	1	1	2CLA218000N1601	5,714
N2180 VD - N2180 VD, Lamp: white LED Luminous flux: > 2 lumen at 1 meter, Green diffuser	1	1	2CLA218000N1801	5,714
N2280 BL - LED signaling light, Lamp: white LED Luminous flux: > 2 lumen at 1 meter, White diffuser	2	1	2CLA228000N1101	10,711
N2281 BL - Beacon LED light, Lamp: white LED Luminous flux: > 2 lumen at 1 meter, white diffuser, Autonomy: 3 hours (1 hour at maximum illumination 2 hours with lower illumination), Battery: Ni-MH (estimated lifetime: 4 years)	2	1	2CLA228100N1101	17,851



2CLA814050  
A1002



2CLA224050  
N1102

Type reference and description	Number of modules	Std pack	Ordering code	Unit M.R.P.(₹)
<b>Thermostat</b>				
8140.5 - Digital room thermostat • Maximum load: 3A cos = 0,5 • Output relay operation modes: Hysteresis: 0.5° C • Pulse-width modulation: with a ±4°C difference with the set-point temperature • Variable from 100% to 0% modulation • To be installed with N2240.5 cover plates	2	1	2CLA814050A1001	42,633
N2240.5 BL - Cover plate for digital thermostat - 2M	2	1	2CLA224050N1101	2,117



2CLA936810A1001



2CLA936820  
A1001



2CLA225710  
N1102

Type reference and description	Number of modules	Std pack	Ordering code	Unit M.R.P.(₹)
<b>Sound</b>				
9368.1 - Multiroom sound module	1	1	2CLA936810A1001	1,00,126
9368.2 - Remote control for multiroom sound module	2	1	2CLA936820A1001	63,834
N2268 BL - Cover plate for radio/remote control modules	-	1	2CLA226800N1101	1,788
9368- FM - Radio and alarm module	2	1	2CLA936800A1001	62,584
N2268 BL - Cover plate for radio/remote control modules	-	1	2CLA226800N1101	1,788
9368.3 - Auxiliary module	2	1	2CLA936830A1001	1,00,101
N2268.3 BL - Cover plate for I/O + USB + Bluetooth module	-	1	2CLA226830N1101	2,157
N2257.1 BL - Speaker connection unit	2	1	2CLA225710N1101	6,656

\* More details will be provided upon request



1SYK100001  
A1071



1SYK100001  
A1072



1SYK100001  
A1073



1SYK100001  
A1074



1SYK100001A1077



1SYK100001A1079

Type reference and description	Number of modules	Std pack	Ordering code	Unit M.R.P.(₹)
<b>White plate with frame</b>				
IIP0133 BL - 1M plate	1	15/360	1SYK100001A1071 ■	235
IIP0233 BL - 2M plate	2	15/360	1SYK100001A1072 ■	253
IIPP343 BL - 3M plate power	3	10/240	1SYK100001A1073 ■	266
IIP0343 BL - 3M plate	3	10/240	1SYK100001A1074 ■	350
IIP0453 BL - 4M plate	4	10/190	1SYK100001A1075 ■	380
IIP0683 BL - 6M plate	6	5/120	1SYK100001A1076 ■	524
IIP0893 BL - 8M plate	8	5/120	1SYK100001A1077 ■	614
IIP0855 BL - 8M plate square	8	5/95	1SYK100001A1078 ■	698
IIP1286 BL - 12M plate	12	5/95	1SYK100001A1079 ■	758
IIP1888 BL - 18M plate	18	5/40	1SYK100001A1080 ■	1,197

■ Stock items

# IVIE complete range

## IVIE mechanisms - Anthracite Grey



1SYK100001A1201

Type reference and description	Number of modules	Std pack	Ordering code	Unit M.R.P.(₹)
<b>Switch 6 A - 240 V ~</b>				
IIS10610 AN - 6A 1 way switch	1	20/400	1SYK100001A1201 ■	231
IIS10620 AN - 6 A 2 way switch	1	20/400	1SYK100001A1202 ■	361



1SYK100001A1209

Type reference and description	Number of modules	Std pack	Ordering code	Unit M.R.P.(₹)
<b>Switch 10 A - 240 V ~</b>				
IIS11010 AN 10A 1 way switch	1	20/400	1SYK100001A1209 ■	246
IIS1101L AN 10A 1 way switch with indicator	1	20/400	1SYK100001A1212 ■	310
IIS11020 AN 10A 2 way switch	1	20/400	1SYK100001A1210	376



1SYK100001A1207

Type reference and description	Number of modules	Std pack	Ordering code	Unit M.R.P.(₹)
<b>Switch 16 A - 240 V ~</b>				
IIS11610 AN - 16A 1 way switch	1	20/400	1SYK100001A1206 ■	452
IIS1161L AN - 16A 1 way switch with ind.	1	20/400	1SYK100001A1207 ■	563



1SYK100001A1208

Type reference and description	Number of modules	Std pack	Ordering code	Unit M.R.P.(₹)
<b>Switch 32 A - 240 V ~</b>				
IIS2321L AN - 32A, DP switch	2	10/200	1SYK100001A1208	1,640



1SYK100001A1203



1SYK100001A1205

Type reference and description	Number of modules	Std pack	Ordering code	Unit M.R.P.(₹)
<b>Bell Push - 240 V ~</b>				
IIS106B0 AN - 6A Bell Switch	1	20/400	1SYK100001A1203	407
IIS106BL AN - 6A Bell Switch with ind.	1	20/400	1SYK100001A1204 ■	524
IIS206BL AN - 6A Mega Bell switch with ind.	2	10/200	1SYK100001A1205	748



1SYK100001A1223



1SYK100001A1128

Type reference and description	Number of modules	Std pack	Ordering code	Unit M.R.P.(₹)
<b>Sockets - 240 V ~</b>				
IIK20616 AN - 6/16A socket	2	10/200	1SYK100001A1223 ■	741
IIK20306 AN - 6A, 3Pin socket	2	10/200	1SYK100001A1228 ■	478



1SYK100001A1260

Type reference and description	Number of modules	Std pack	Ordering code	Unit M.R.P.(₹)
<b>USB chargers</b>				
IIM1USBC AN 2A 1M USB Charger	1	1	1SYK100001A1260 ■	2,100
IIM2USBC AN 3A 2M USB Charger	2	1	1SYK100001A1261	3,045



1SYK100001A1241

Type reference and description	Number of modules	Std pack	Ordering code	Unit M.R.P.(₹)
<b>Blank plates</b>				
IIM1BLNK AN - Blank plate	1	20/400	1SYK100001A1241 ■	149

■ Stock items

# IVIE complete range

## IVIE mechanisms - Anthracite Grey



1SYK100001A1242



2CLA226020N1801



2CLA226030N1801



2CLA226080N1801



2CLA226090N1801



1SYK100001A1247



1SYK100001A1249



1SYK100001A1257



1SYK100001A1255



2CLA221410N1801

Type reference and description	Number of modules	Std pack	Ordering code	Unit M.R.P.(₹)
<b>Motion sensor</b>				
IIM2FR05 AN - Step fan regulator 5 step	2	5/100	1SYK100001A1242 ■	1,554
IIM1FR04 AN - Step fan regulator 4 step	1	10/200	1SYK100001A1243 ■	1,376
IIM1D400 AN - Dimmer 400 Watt	1	10/200	1SYK100001A1245	1,825
N2260.2 AN - Universal rotatory/push dimmer • Rated voltage: 230 V AC • Max. power: Incandescent: 500 W • Halogen lamp with electronic transformer: 500 VA • Halogen lamp with ferromagnetic transformer: 400 VA	2	1	2CLA226020N1801	45,711
N2260.3 AN - LED rotatory/push dimmer • Rated voltage: 230 V AC • Nominal power: 250 W/VA • Power (min./max load): LEDi: 2/100 W/VA (max. 10 lamps). Dimmable energy saving lamps: 2/100 W/VA (max. 10 lamps) • LV LEDi with transformer (only type L or LC): 4/100 W/VA (max. 10 lamps) • Incandescent lamps: 10/250 W/VA • Halogen lamps: 10/250 W/VA • LV halogen with transformer (only type L or LC): 10/250 W/VA (max. 10 lamps) • 2 wire connection • Optional: auxiliary on/off with 2-way switch N2X02	2	1	2CLA226030N1801	28,409
N2260.8 AN - LED rotatory/push dimmer • Rated voltage: 127 V AC • Frequency: 50/60 Hz (Nominal power: 140 W/ VA) • Power (min./max load): LEDi: 2/55 W/VA (max. 10 lamps) • Dimmable energy saving lamps: 2/55 W/VA (max. 10 lamps) • LV LEDi with transformer (only type L or LC): 4/55 W/VA (max. 10 lamps) • Incandescent lamps: 10/140 W/VA • Halogen lamps: 10/140 W/VA • LV halogen with transformer (only type L or LC): 10/140 W/VA (max. 10 lamps)	2	1	2CLA226080N1801	23,012
N2260.9 AN - 1-10V rotary dimmer • Rated voltage: 127 - 230 V AC / 50 - 60 Hz • Max. power: 230 V AC: 700 VA • 127 V AC: 350 VA • Max. 6 ballasts per device	2	1	2CLA226090N1801	15,710

Type reference and description	Number of modules	Std pack	Ordering code	Unit M.R.P.(₹)
<b>Data &amp; Voice</b>				
IIM1RJ11 AN - RJ11 Tel. jack 2 pin	1	20/400	1SYK100001A1247 ■	375
IIM1RJ45 AN - RJ45 Jack cat 6	1	20/400	1SYK100001A1248 ■	1,219

Type reference and description	Number of modules	Std pack	Ordering code	Unit M.R.P.(₹)
<b>TV socket</b>				
IIM1TVSK AN - TV co-axial socket	1	20/400	1SYK100001A1249 ■	445

Type reference and description	Number of modules	Std pack	Ordering code	Unit M.R.P.(₹)
<b>Shaver socket</b>				
IIM2SVSK AN - Shaver Socket	2	5/100	1SYK100001A1257	2,205

Type reference and description	Number of modules	Std pack	Ordering code	Unit M.R.P.(₹)
<b>DND &amp; MMR</b>				
IIM1DNDS AN - DND and MMR set internal & external	2+3	5/100	1SYK100001A1255	2,456
N2244.5 AN - DND and MUR 2-gang interlocked switch	2	1	2CLA224450N1801	7,478
N2180.4 AN - LED MUR signaling light	1	1	2CLA218050N1801	7,141
N2180.4 AN - LED DND signaling light	1	1	2CLA218040N1801	7,141

Type reference and description	Number of modules	Std pack	Ordering code	Unit M.R.P.(₹)
<b>Key card switches</b>				
- Card switch 1-gang, 1-way, DP	2	1	2CLA221410N1801	6,791

■ Stock items

# IVIE complete range

## IVIE mechanisms - Anthracite Grey



1SYK100001A1259

Type reference and description	Number of modules	Std pack	Ordering code	Unit M.R.P.(₹)
<b>Down lighter</b>				
IIM3DOWN AN - Down lighter	3	5/100	1SYK100001A1259 ■	1,382



2CLA215520N1802



2CLA215530N1802



2CLA215540N1802



2CLA215550N1802



2CLA215560N1802



2CLA215580N1802

Type reference and description	Number of modules	Std pack	Ordering code	Unit M.R.P.(₹)
<b>Audio &amp; Video Connector</b>				
N2155.2 AN - 2x RCA connection unit	1	1	2CLA215520N1801	Upon request
N2155.3 AN - 3x RCA connection unit	1	1	2CLA215530N1801	
N2155.4 AN - Mini-Jack connection unit	1	1	2CLA215540N1801	
N2155.5 AN - VGA connection unit	1	1	2CLA215550N1801	
N2155.6 AN - HDMI connection unit	1	1	2CLA215560N1801	
N2155.7 AN - HDMI female-female connection unit	1	1	2CLA215570N1801	
N2155.8 AN - USB connection unit	1	1	2CLA215580N1801	
N2155.9 AN - USB female-female connection unit	1	1	2CLA215590N1801	

Type reference and description	Number of modules	Std pack	Ordering code	Unit M.R.P.(₹)
<b>Motion Sensor</b>				
N2241 AN - 110° motion sensor • Max. power: Incandescent: 1.800W @230V AC/1.000W @127V AC • Halogen with electronic or ferromagnetic transformer: 750VA @230V AC/400VA @127V AC • Fluorescent lamps or motors: 400VA @230V AC/200VA @127V AC • For automatic switching of devices dependent on motion and brightness • With integrated selector switch for automatic ON-OFF in the front side • Switch-off delay: 10 sec. to 10 min. or short-time pulse 1 sec adjustable (from the front side) • Detection range: 5 m radius Adjustable light set point level for activation (from the front side) • Detection angle: 110° Mounting height: 1, 2 m auxiliary control with N2X04.X push-buttons	2	1	2CLA224100N1801	Upon request



2CLA211900N1802



2CLA221900N1802

Type reference and description	Number of modules	Std pack	Ordering code	Unit M.R.P.(₹)
<b>Buzzer &amp; Door Bell</b>				
IM2BUZR AN - Buzzer	2	5/100	1SYK100001A1254	867
N2119 AN - Buzzer	1	1	2CLA211900N1801	Upon request
N2219 AN - Buzzer	2	1	2CLA221900N1801	
N2224 AN - Electronic door bell 230 V AC	2	1	2CLA222400N1801	

Type reference and description	Number of modules	Std pack	Ordering code	Unit M.R.P.(₹)
<b>Indicator</b>				
IIM1INDI AN - Indicator	1	20/400	1SYK100001A1253	520

Type reference and description	Number of modules	Std pack	Ordering code	Unit M.R.P.(₹)
<b>Thermostat</b>				
N2240.5 AN - Cover plate for digital thermostat	2	1	2CLA224050N1801	Upon request

■ Stock items

# IVIE complete range

## IVIE accessories - Anthracite Grey

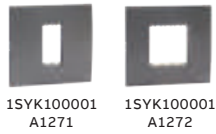

Type reference and description	Number of modules	Std pack	Ordering code	Unit M.R.P.(₹)
<b>Anthracite plate with frame</b>				
IIP0133 AN - 1M plate	1	15/360	1SYK100001A1271 ■	525
IIP0233 AN - 2M plate	2	15/360	1SYK100001A1272 ■	544
IIPP343 AN - 3M plate power	3	10/240	1SYK100001A1273 ■	620
IIP0343 AN - 3M plate	3	10/240	1SYK100001A1274 ■	739
IIP0453 AN - 4M plate	4	10/190	1SYK100001A1275 ■	929
IIP0683 AN - 6M plate	6	5/120	1SYK100001A1276 ■	1,162
IIP0893 AN - 8M plate	8	5/120	1SYK100001A1277 ■	1,345
IIP0855 AN - 8M plate square	8	5/95	1SYK100001A1278	1,458
IIP1286 AN - 12M plate	12	5/95	1SYK100001A1279 ■	1,952
IIP1888 AN - 18M plate	18	5/40	1SYK100001A1280	2,747

## IVIE installation system

IVIE series is a grid type system enabling combination of colours and products of different dimensions and functionalities, together with ABB-free@home® sensors that have to be composed with the required frame, in order to have the right assortment of functionality and design.

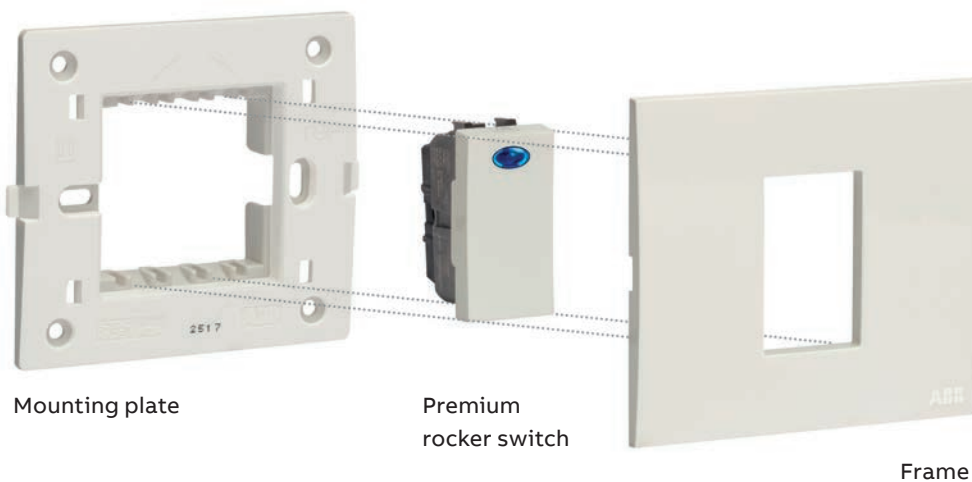

# IVIE complete range

## IVIE mechanisms - Silver



1SYK100001A1101

Type reference and description	Number of modules	Std pack	Ordering code	Unit M.R.P.(₹)
<b>Switch 6 A - 240 V ~</b>				
IIS10610 PL - 6A 1 way switch	1	20/400	1SYK100001A1101 ■	231
IIS10620 PL - 6A 2 way switch	1	20/400	1SYK100001A1102 ■	361



1SYK100001A1109

Type reference and description	Number of modules	Std pack	Ordering code	Unit M.R.P.(₹)
<b>Switch 10 A - 240 V ~</b>				
IIS11010 PL 10A 1 way switch	1	20/400	1SYK100001A1109 ■	246
IIS1101L PL 10A 1 way switch with indicator	1	20/400	1SYK100001A1112 ■	310
IIS11020 PL 10A 2 way switch	1	20/400	1SYK100001A1110	376



1SYK100001A1107

Type reference and description	Number of modules	Std pack	Ordering code	Unit M.R.P.(₹)
<b>Switch 16 A - 240 V ~</b>				
IIS11610 PL - 16A 1 way switch	1	20/400	1SYK100001A1106 ■	452
IIS1161L PL - 16A 1 way switch with Ind.	1	20/400	1SYK100001A1107 ■	563



1SYK100001A1108

Type reference and description	Number of modules	Std pack	Ordering code	Unit M.R.P.(₹)
<b>Switch 32 A - 240 V ~</b>				
IIS2321L PL - 32A, DP switch	2	10/200	1SYK100001A1108	1,609



1SYK100001A1003



1SYK100001A1105

Type reference and description	Number of modules	Std pack	Ordering code	Unit M.R.P.(₹)
<b>Bell Push - 240 V ~</b>				
IIS106B0 PL - 6A Bell Switch	1	20/400	1SYK100001A1103 ■	407
IIS106BL PL - 6A Bell Switch with Ind.	1	20/400	1SYK100001A1104 ■	524
IIS206BL PL - 6A Mega bell switch with Ind.	2	10/200	1SYK100001A1105 ■	748



1SYK100001A1123



1SYK100001A1128

Type reference and description	Number of modules	Std pack	Ordering code	Unit M.R.P.(₹)
<b>Sockets - 240 V ~</b>				
IIK20616 PL - 6/16A socket	2	10/200	1SYK100001A1123 ■	741
IIK20306 PL - 6A, 3Pin socket	2	10/200	1SYK100001A1128 ■	474



1SYK100001A1160



1SYK100001A1161

Type reference and description	Number of modules	Std pack	Ordering code	Unit M.R.P.(₹)
<b>USB Chargers</b>				
IIM1USBC PL 2A 1M USB Charger	1	1	1SYK100001A1160 ■	2,100
IIM2USBC PL 3A 2M USB Charger	2	1	1SYK100001A1161	3,045

Type reference and description	Number of modules	Std pack	Ordering code	Unit M.R.P.(₹)
<b>Blank Plates</b>				
IIM1BLNK PL - Blank Plate	1	20/400	1SYK100001A1141 ■	149

■ Stock items

# IVIE complete range

## IVIE mechanisms - Silver



1SYK100001A1142



2CLA226030N1301



2CLA226030N1301



2CLA226080N1301



2CLA226090N1301

Type reference and description	Number of modules	Std pack	Ordering code	Unit M.R.P.(₹)
<b>Dimmer &amp; Fan Regulators</b>				
IIM2FR05 PL - Step fan regulator 5 step	2	5/100	1SYK100001A1142 ■	1,561
IIM1FR04 PL - Step fan regulator 4 step	1	10/200	1SYK100001A1143 ■	1,371
IIM1D400 PL - Dimmer 400 Watt	1	10/200	1SYK100001A1145	1,825
N2260.2 PL - Universal rotatory/push dimmer • Rated voltage: 230 V AC • Max. power: Incandescent: 500 W • Halogen lamp with electronic transformer: 500 VA • Halogen lamp with ferromagnetic transformer: 400 VA.	2	1	2CLA226020N1301	Upon request
N2260.3 PL - LED rotatory/push dimmer 230 V AC • Rated voltage: 230 V AC, Nominal power: 250 W/VA • Power (min./max load): LEDi: 2/100 W/VA (max. 10 lamps) • Dimmable energy saving lamps: 2/100 W/VA (max. 10 lamps) • LV LEDi with transformer (only type L or LC): 4/100 W/VA (max. 10 lamps) • Incandescent lamps: 10/250 W/VA • Halogen lamps: 10/250 W/VA • LV halogen with transformer (only type L or LC): 10/250 W/VA (max. 10 lamps) • 2 wire connection • Optional: auxiliary on/off with 2-way switch N2X02	2	1	2CLA226030N1301	
N2260.8 PL - LED rotatory/push dimmer 127 V AC • Rated voltage: 127 V AC, Frequency: 50/60 Hz (Nominal power: 140 W/VA) • Power (min./max load): LEDi: 2/55 W/VA (max. 10 lamps) • Dimmable energy saving lamps: 2/55 W/VA (max. 10 lamps) • LV LEDi with transformer (only type L or LC): 4/55 W/VA (max. 10 lamps) • Incandescent lamps: 10/140 W/VA • Halogen lamps: 10/140 W/VA • LV halogen with transformer (only type L or LC): 10/140 W/VA (max. 10 lamps)	2	1	2CLA226080N1301	
N2260.9 PL - 1-10V rotary dimmer • Rated voltage: 127 - 230 V AC/50 - 60 Hz • Max. power: 230 Vac: 700 VA • 127 Vac: 350 VA • Max. 6 ballasts per device	2	1	2CLA226090N1301	



1SYK100001A1147



1SYK100001A1149

Type reference and description	Number of modules	Std pack	Ordering code	Unit M.R.P.(₹)
<b>Data &amp; Voice</b>				
IIM1RJ11 PL - RJ11 Tel. jack 2 pin	1	20/400	1SYK100001A1147 ■	375
IIM1RJ45 PL - RJ45 Jack cat 6	1	20/400	1SYK100001A1148 ■	1,219



1SYK100001A1157

Type reference and description	Number of modules	Std pack	Ordering code	Unit M.R.P.(₹)
<b>TV Socket</b>				
IIM1TVSK PL - TV co-axial socket	1	20/400	1SYK100001A1149 ■	445

Type reference and description	Number of modules	Std pack	Ordering code	Unit M.R.P.(₹)
<b>Shaver Socket</b>				
IIM2SVSK PL - Shaver Socket	2	5/100	1SYK100001A1157	2,205



2CLA218040N1301

Type reference and description	Number of modules	Std pack	Ordering code	Unit M.R.P.(₹)
<b>DND &amp; MMR</b>				
IIM1DND5 PL - DND and MMR set internal & external	2+3	5/100	1SYK100001A1155	2,748
N2244.5 PL - DND and MUR 2-gang interlocked switch	1	1	2CLA224450N1301	Upon request
N2180.4 PL - LED DND signaling light	2	1	2CLA218040N1301	
N2180.4 BL - LED MUR signaling light	1	1	2CLA218050N1101	

# IVIE complete range

## IVIE mechanisms - Silver



2CLA221410N1301



1SYK100001A1159



2CLA215520N1302



2CLA215530N1302



2CLA215540N1302



2CLA215550N1302



2CLA215560N1302



2CLA215580N1302

Type reference and description	Number of modules	Std pack	Ordering code	Unit M.R.P.(₹)
<b>Key Card Switches</b>				
N2214.1 PL - Card switch 1-gang, 1-way, DP	2	1	2CLA221410N1301	8,097

Type reference and description	Number of modules	Std pack	Ordering code	Unit M.R.P.(₹)
<b>Down Lighter</b>				
IIM3DOWN PL - Down lighter	2	5/100	1SYK100001A1159	1,388

Type reference and description	Number of modules	Std pack	Ordering code	Unit M.R.P.(₹)
<b>Audio &amp; Video Connector</b>				
N2155.2 PL - 2x RCA connection unit	1	1	2CLA215520N1301	Upon request
N2155.3 PL - 3x RCA connection unit	1	1	2CLA215530N1301	
N2155.4 PL - Mini-Jack connection unit	1	1	2CLA215540N1301	
N2155.5 PL - VGA connection unit	1	1	2CLA215550N1301	
N2155.6 PL - HDMI connection unit	1	1	2CLA215560N1301	
N2155.7 PL - HDMI female-female connection unit	1	1	2CLA215570N1301	
N2155.8 PL - USB connection unit	1	1	2CLA215580N1301	
N2155.9 PL - USB female-female connection unit	1	1	2CLA215590N1301	

Type reference and description	Number of modules	Std pack	Ordering code	Unit M.R.P.(₹)
<b>Motion Sensor</b>				
N2241 PL - 110° motion sensor Max. power: Incandescent: 1.800W @230V AC/1.000W @127V AC • Halogen with electronic or ferromagnetic transformer: 750VA @230V AC/400VA @127V AC - Fluorescent lamps or motors: 400VA @230V / 200VA @127Vac • For automatic switching of devices dependent on motion and brightness • With integrated selector switch for automatic ON-OFF in the front side, Switch-off delay: 10 sec to 10 min or short-time pulse 1 sec adjustable (from the front side) • Detection range: 5 m radius Adjustable light set point level for activation (from the front side) • Detection angle: 110° Mounting height: 1, 2 m Auxiliary control with N2X04.X push-buttons	2	1	2CLA224100N1301	Upon request



2CLA211900N1302



2CLA221900N1302

Type reference and description	Number of modules	Std pack	Ordering code	Unit M.R.P.(₹)
<b>Buzzer &amp; Door Bell</b>				
IIM2BUZR PL - Buzzer	2	5/100	1SYK100001A1154	938
N2119 PL - Buzzer	1	1	2CLA211900N1301	Upon request
N2219 PL - Buzzer	2	1	2CLA221900N1301	
N2224 PL - Electronic door bell 230 V AC	2	1	2CLA222400N1301	

Type reference and description	Number of modules	Std pack	Ordering code	Unit M.R.P.(₹)
<b>Indicator</b>				
IIM1INDI PL - Indicator	1	20/400	1SYK100001A1153	550

Type reference and description	Number of modules	Std pack	Ordering code	Unit M.R.P.(₹)
<b>Thermostat</b>				
N2240.5 PL - Cover plate for digital thermostat	2	1	2CLA224050N1301	Upon request



# IVIE complete range

## IVIE mechanisms - Silver

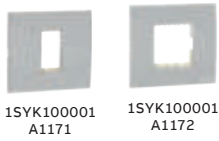

### Plates

Type reference and description	Number of modules	Std pack	Ordering code	Unit M.R.P.(₹)
<b>Silver plate with frame</b>				
IIP0133 PL - 1M plate	1	15/360	1SYK100001A1171 ■	525
IIP0233 PL - 2M plate	2	15/360	1SYK100001A1172 ■	544
IIPP343 PL - 3M plate power	3	10/240	1SYK100001A1173 ■	626
IIP0343 PL - 3M plate	3	10/240	1SYK100001A1174 ■	739
IIP0453 PL - 4M plate	4	10/190	1SYK100001A1175 ■	929
IIP0683 PL - 6M plate	6	5/120	1SYK100001A1176 ■	1,162
IIP0893 PL - 8M plate	8	5/120	1SYK100001A1177 ■	1,345
IIP0855 PL - 8M plate square	8	5/95	1SYK100001A1178	1,458
IIP1286 PL - 12M plate	12	5/95	1SYK100001A1179 ■	1,952
IIP1888 PL - 18M plate	18	5/40	1SYK100001A1180	2,747

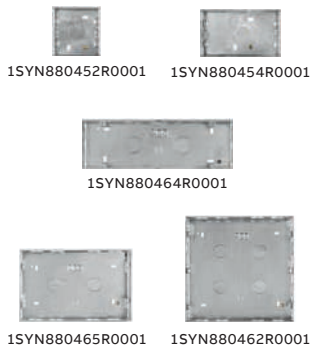

### Metal flush boxes

Type reference and description	Number of modules	Std pack	Ordering code	Unit M.R.P.(₹)
<b>Flush boxes</b>				
Metal Box 1-2M - CMBZ3302	1/2	108	1SYN880452R0001 ■	155
Metal Box 3M - CMBZ4303	3	82	1SYN880453R0001 ■	161
Metal Box 4-5M - CMBZ5305	4	60	1SYN880454R0001 ■	204
Metal Box 6M - CMBZ8306	6	40	1SYN880463R0001 ■	334
Metal Box 8M - CMBZ9308	8	39	1SYN880464R0001 ■	463
Metal Box 8MV - CMBZ5508V	8	26	1SYN880456R0001 ■	433
Metal Box 12M - CMBZ8612	12	16	1SYN880465R0001 ■	507
Metal Box 18M - CMBZ8824	18	10	1SYN880462R0001 ■	803

## Metal Flush Boxes

**NEW**

- New locking design form front and bottom for more strength
- Strengthening profile change to more strength of box
- New finish
- Knock out for conduit pipe entry from any direction (Top, Bottom, Side and Back)
- Possible to break open knockout without any special tool
- Optimized packaging quantity

### Metal flush boxes



Type reference and description	Number of modules	Std pack	Ordering code	Unit M.R.P.(₹)
<b>Flush boxes</b>				
Metal Box 1-2M - NM CMBZ3302	1/2	40	1SYN890452R0001 ■	140
Metal Box 3M - NM CMBZ4303	3	40	1SYN890453R0001 ■	145
Metal Box 4-5M -NM CMBZ5305	4	40	1SYN890454R0001 ■	185
Metal Box 6M -NM CMBZ8306	6	40	1SYN890463R0001 ■	284
Metal Box 8M -NM CMBZ9308	8	40	1SYN890464R0001 ■	394
Metal Box 12M -NM CMBZ8612	12	10	1SYN890465R0001 ■	456

■ Stock items

# Tvisha

## Wiring accessories

### Switch on simplicity

Tvisha is a range of wiring accessories with simple flat surface design that creates a trend on the wall with its elegant Euro white finish. The range covers a large variety of functionalities that caters to most of the applications beyond the normal switching functions like USB chargers, HDMI ports, communication sockets, foot lamps and dimmers. Tvisha is ideal for residential and commercial requirements.

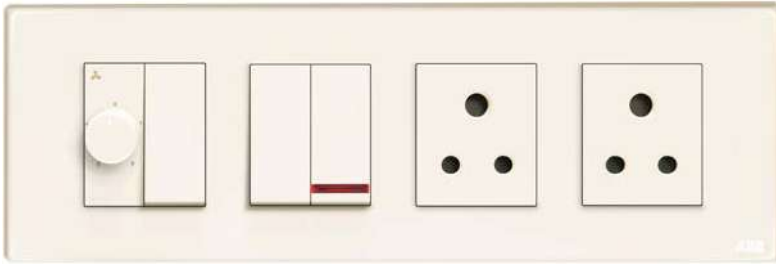

- Plastic parts which hold current carrying parts are made of PA6 20% glass filled rating upto 16A
- All switches are marked with IS 3854:1997
- Terminals are designed in such a way that wire is tightened without damage
- Bi-metal silver contact tips for less spark and longer life
- 6A & 6/16A marked with IS 1293, up to 16A
- Non-flammable thermoplastic resin parts and a very high insulating resistance after humidity test



Internal arc shield provided in switch mechanism



Terminal screws with Combihead for star /flat screw drivers.



20A DP switch in one module (space optimisation)



Top entry

Easy terminal accessibility by top entry to load connection.



ISI marking on switch socket and fan regulator and laser marked.

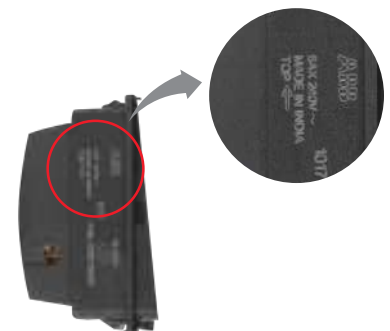

Laser marking and arrow showing the correct orientation of the mechanism.

# Tvisha

## Wiring accessories

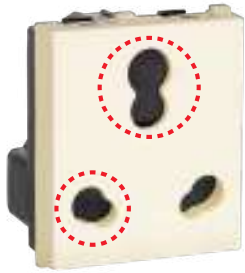

6/16A sockets are equipped with dual shutters which can take two pin plugs.



Universal regulator with 360 degree rotation.



Mounting screws press fitted on the screw holder on inner frame to avoid losing the screws.



Two module partition is provided for sturdiness with extra ribs to ensure better strength of the frame and overlap of plugs.

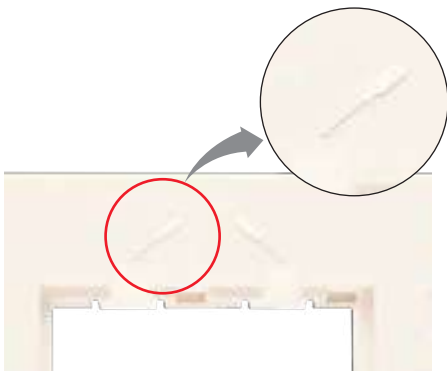

Visual signs provided in inner grids to guide proper fitment for easy installation and easy removal during fitment of mechanism with inner grid.



Resin frame with extra ribs provides better mechanical strength, insulation resistance and corrosion proof.

# Tvisha

## Switches, sockets, plates and accessories



**NEW**

### Switches

Item description	Module size	Std pack	Ordering code	Unit M.R.P.(₹)
ITS10610 BL 6A 1 way switch	1 M	20	1SYK100001A1501 ■	137
ITS1061L BL 6A 1 way switch with Ind.	1 M	20	1SYK100001A1502	252
ITS10620 BL 6A 2 way switch	1 M	20	1SYK100001A1503 ■	223
ITS106B0 BL 6A Bell switch	1 M	20	1SYK100001A1504 ■	242
ITS106BL BL 6A Bell switch with Ind.	1 M	20	1SYK100001A1505 ■	337
ITS11010 BL 10A 1 way switch	1 M	20	1SYK100001A1513 ■	152
ITS1101L BL 10A 1 way switch with Ind.	1 M	20	1SYK100001A1514 ■	267
ITS11020 BL 10A 2 way switch	1 M	20	1SYK100001A1515	238
ITS11610 BL 16A 1 way switch	1 M	20	1SYK100001A1506 ■	260
ITS1161L BL 16A 1 way switch with Ind.	1 M	20	1SYK100001A1507 ■	318
ITS1201L BL 20A DP Switch 1 way with Ind.	1 M	20	1SYK100001A1508 ■	731
ITS206BL BL 6A Bell Mega switch with Ind.	2 M	10	1SYK100001A1509 ■	432
ITS2062L BL 6A 2 way Mega switch with Ind.	2 M	10	1SYK100001A1510	520
ITS2162L BL 16A 2 way Mega switch with Ind.	2 M	10	1SYK100001A1511	547
ITS2321L BL 32A 1 Way DP Mega switch with Ind.	2 M	10	1SYK100001A1512 ■	686

### Sockets

Item description	Module size	Std pack	Ordering code	Unit M.R.P.(₹)
ITK20306 BL 6A 3Pin Socket	2 M	10	1SYK100001A1527 ■	224
ITK20616 BL 6/16A Socket	2 M	10	1SYK100001A1523 ■	418



### Support accessories

Item description	Module size	Std pack	Ordering code	Unit M.R.P.(₹)
ITM1BLNK BL Blank plate	1 M	20	1SYK100001A1541 ■	55
ITM2FR05 BL Fan regulator 5 step	2 M	5	1SYK100001A1542 ■	946
ITM1FR04 BL Fan regulator 4 step	1 M	10	1SYK100001A1543 ■	699
ITM1RJ11 BL RJ 11TEL 2 Pin	1 M	20	1SYK100001A1544 ■	214
ITM1RJ45 BL RJ 45 Jack CAT 6	1 M	20	1SYK100001A1545 ■	863
ITM1TVSK BL TV socket	1 M	20	1SYK100001A1546 ■	221
ITM1FLEX BL Flex outlet	1 M	20	1SYK100001A1547	204
ITM2LDFL BL LED foot lamp	2 M	10	1SYK100001A1550 ■	698
ITM1INDI BL Indicator	1 M	5	1SYK100001A1551 ■	380
ITM1USBC BL 2A 1M USB Charger	1 M	5	1SYK100001A1557 ■	1,890
ITM2USBC BL USB charger 2A	2 M	10	1SYK100001A1553	2,521
ITM1HDMI BL HDMI Port 2.0	1 M	20	1SYK100001A1554	2,154
ITM1D400 BL Dimmer 400W	1 M	20	1SYK100001A1548	1,048
ITM2D1000 BL Dimmer 1000W	1 M	20	1SYK100001A1549	1,327
ITM2MS20 BL Single Phase Starter 20A	2 M	5	1SYK100001A1555	1,251
ITM2MS25 BL Single Phase Starter 25A	2 M	5	1SYK100001A1556 ■	1,360

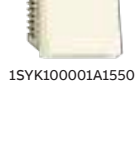

■ Stock items

# Tvisha

## Switches, sockets, plates and accessories



### Plates

Item description	Module size	Std pack	Ordering code	Unit M.R.P. (₹)
ITP0133 BL 1 M Plate	1 M	15	1SYK100001A1571 ■	147
ITP0233 BL 2 M Plate	2 M	15	1SYK100001A1572 ■	147
ITPP343 BL 3 M Plate power	3 M	10	1SYK100001A1573 ■	190
ITP0453 BL 4 M Plate	4 M	10	1SYK100001A1574 ■	208
ITP0683 BL 6 M Plate	6 M	5	1SYK100001A1575 ■	334
ITP0893 BL 8 M Plate	8 M	5	1SYK100001A1576 ■	385
ITP0855 BL 8 M Plate square	8 M	5	1SYK100001A1577 ■	496
ITP1286 BL 12 M Plate	12 M	5	1SYK100001A1578 ■	637
ITP1696 BL 16M Plate	16 M	5	1SYK100001A1579 ■	714
ITP1888 BL 18M Plate	18 M	5	1SYK100001A1580 ■	858



### Metal flush boxes

Type reference and description	Number of modules	Std pack	Ordering code	Unit M.R.P. (₹)
<b>Flush boxes</b>				
Metal Box 1-2M - CMBZ3302	1/2	108	1SYN880452R0001 ■	155
Metal Box 3M - CMBZ4303	3	82	1SYN880453R0001 ■	161
Metal Box 4-5M - CMBZ5305	4	60	1SYN880454R0001 ■	204
Metal Box 6M - CMBZ8306	6	40	1SYN880463R0001 ■	334
Metal Box 8M - CMBZ9308	8	39	1SYN880464R0001 ■	463
Metal Box 8MV - CMBZ5508V	8	26	1SYN880456R0001 ■	433
Metal Box 12M - CMBZ8612	12	16	1SYN880465R0001 ■	507
Metal Box 16M - CMBZ9616	12	15	1SYN880466R0001 ■	668
Metal Box 18M - CMBZ8824	18	10	1SYN880462R0001 ■	803

## Metal Flush Boxes

**NEW**

- New locking design form front and bottom for more strength
- Strengthening profile change to more strength of box
- New finish
- Knock out for conduit pipe entry from any direction (Top, Bottom, Side and Back)
- Possible to break open knockout without any special tool
- Optimized packaging quantity

### Metal flush boxes

Type reference and description	Number of modules	Std pack	Ordering code	Unit M.R.P. (₹)
<b>Flush boxes</b>				
Metal Box 1-2M - NM CMBZ3302	1/2	40	1SYN890452R0001 ■	140
Metal Box 3M - NM CMBZ4303	3	40	1SYN890453R0001 ■	145
Metal Box 4-5M -NM CMBZ5305	4	40	1SYN890454R0001 ■	185
Metal Box 6M -NM CMBZ8306	6	40	1SYN890463R0001 ■	284
Metal Box 8M -NM CMBZ9308	8	40	1SYN890464R0001 ■	394
Metal Box 12M -NM CMBZ8612	12	10	1SYN890465R0001 ■	456



■ Stock items

# Tvisha (White)

## Wiring accessories



1SYK100001A1801 1SYK100001A1804



1SYK100001A1805 1SYK100001A1809



1SYK100001A1808 1SYK100001A1812

### Switches

Item description	Module size	Std pack	Ordering code	Unit M.R.P. (₹)
ITS10610 RW 6A 1 way switch	1 M	20	1SYK100001A1801	145
ITS1061L RW 6A 1 way switch with Ind.	1 M	20	1SYK100001A1802	268
ITS10620 RW 6A 2 way switch	1 M	20	1SYK100001A1803	235
ITS106B0 RW 6A Bell Switch	1 M	20	1SYK100001A1804	256
ITS106BL RW 6A Bell Switch with Ind.	1 M	20	1SYK100001A1805	357
ITS11610 RW 16A 1 way switch	1 M	20	1SYK100001A1806	276
ITS1161L RW 16A 1 way switch with Ind.	1 M	20	1SYK100001A1807	337
ITS1201L RW 20A DP Switch 1 way with Ind.	1 M	20	1SYK100001A1808	775
ITS206BL RW 6A Bell Mega Switch with Ind.	2 M	10	1SYK100001A1809	458
ITS2062L RW 6A 2 way Mega Switch with Ind	2 M	10	1SYK100001A1810	551
ITS2162L RW 16A 2 way Mega Switch with Ind	2 M	10	1SYK100001A1811	580
ITS2321L RW 32A 1 Way DP Mega Switch with Ind.	2 M	10	1SYK100001A1812	775



1SYK100001A1827 1SYK100001A1823

### Sockets

Item description	Module size	Std pack	Ordering code	Unit M.R.P. (₹)
ITK20006 RW 6A 3 Pin Socket	2 M	10	1SYK100001A1827	237
ITK20616 RW 6/16A Socket	2 M	10	1SYK100001A1823	443



1SYK100001A1842 1SYK100001A1843



1SYK100001A1844 1SYK100001A1845



1SYK100001A1854 1SYK100001A1846



1SYK100001A1857



1SYK100001A1850 1SYK100001A1855

### Support accessories

Item description	Module size	Std pack	Ordering code	Unit M.R.P. (₹)
ITM1BLNK RW Blank Plate	1 M	20	1SYK100001A1841	59
ITM2FR05 RW Fan Regulator 5 Step	2 M	5	1SYK100001A1842	1,004
ITM1FR04 RW Fan Regulator 4 Step	1 M	10	1SYK100001A1843	740
ITM1RJ11 RW RJ 11TEL 2 Pin	1 M	20	1SYK100001A1844	227
ITM1RJ45 RW RJ 45 Jack CAT 6	1 M	20	1SYK100001A1845	915
ITM1TVSK RW TV Socket	1 M	20	1SYK100001A1846	234
ITM1FLEX RW Flex outlet	1 M	20	1SYK100001A1847	215
ITM1D400 RW Dimmer 400W	1 M	10	1SYK100001A1848	1,111
ITM2D1000 RW Dimmer 1000W	2 M	5	1SYK100001A1849	1,407
ITM2LDL RW LED Foot Lamp	2 M	5	1SYK100001A1850	740
ITM1INDI RW Indicator	1 M	10	1SYK100001A1851	376
ITM1USBC RW 2A 1M USB Charger	1 M	20	1SYK100001A1857	1,890
ITM1HDMI RW HDMI Port 2.0	1 M	20	1SYK100001A1854	2,283
ITM2MS20 RW Motor Starter 20A	2 M	5	1SYK100001A1855	1,326
ITM2MS25 RW Motor Starter 25A	2 M	5	1SYK100001A1856	1,442

# Tvisha (White)

## Wiring accessories



1SYK100001A1871



1SYK100001A1872



1SYK100001A1873



1SYK100001A1874



1SYK100001A1880

### Plates

Item description	Module size	Std pack	Ordering code	Unit M.R.P. (₹)
ITPO133 RW 1 M Plate	1 M	15	1SYK100001A1871	155
ITPO233 RW 2 M Plate	2 M	15	1SYK100001A1872	155
ITPP343 RW 3 M Plate Power	3 M	10	1SYK100001A1873	202
ITPO453 RW 4 M Plate	4 M	10	1SYK100001A1874	221
ITPO683 RW 6 M Plate	6 M	5	1SYK100001A1875	354
ITPO893 RW 8 M Plate	8 M	5	1SYK100001A1876	408
ITPO855 RW 8 M Plate Square	8 M	5	1SYK100001A1877	525
ITP1286 RW 12 M Plate	12 M	5	1SYK100001A1878	675
ITP1696 RW 16M Plate	16 M	5	1SYK100001A1879	757
ITP1888 RW 18M Plate	18 M	5	1SYK100001A1880	909



# Tvisha

## Anti-bacterial range



Switches with double shrouds



Socket with separate shutter



Frame with partition



Knobs with 360° rotation



\*Ordering codes and prices on request



# Snieo

## Wiring accessories

### Classic ideas never go out of style

Snieo combines modern design with high-performance materials such as premium thermoplastic resin. Our switches are made of fire retardant substances with superior electrical properties. Chamfered edges prevent dust accumulation and well crafted sockets provide an enduring grip for a variety of plugs.



#### Switch modules

Description	Module size	Std pack	Ordering code	Unit M.R.P. (₹)
6A 1 way switch - CPW10610	1	25	1SYN880676R0001 ■	153
6A 2 way switch - CPW10620	1	25	1SYN880677R0001 ■	218
6A Bell Push - CPW106B0	1	25	1SYN880676R0002 ■	237
6A 1 way switch LED - CPW1061L	1	25	1SYN880676R0003	261
6A Bell Push LED - CPW106BL	1	25	1SYN880676R0004 ■	352
10A 1 Way Switch - CPW11010	1	25	1SYN880676R0008 ■	168
10A 2 Way Switch - CPW11020	1	25	1SYN880677R0003 ■	233
10A 1 way switch LED - CPW1101L	1	25	1SYN880676R0010	276
16A 1 way switch - CPW11610	1	25	1SYN880676R0005 ■	229
16A 2 way switch - CPW11620	1	25	1SYN880677R0002 ■	381
16A 1 way switch with LED - CPW1161L	1	25	1SYN880676R0006 ■	308
20A DP Switch 1 way with LED - CPW1201L	2	20	1SYN880670R0001 ■	477
6A 1 way Mega switch with LED - CPW2061L	2	10	1SYN880652R0001	416
6A 2 way Mega switch with LED - CPW2062L	2	10	1SYN880652R0002	470
6A Mega Bell Push with LED - CPW206BL	2	10	1SYN880652R0003 ■	414
16A 1 way Mega switch with LED - CPW2161L	2	10	1SYN880653R0001	528
16A 2 way Mega switch with LED - CPW2162L	2	10	1SYN880653R0002	530
32A 1 way DP Switch with LED - CPW2321DPL	2	10	1SYN880655R0001 ■	601

NEW

#### Socket modules

Description	Module size	Std pack	Ordering code	Unit M.R.P. (₹)
6A 3 Pin Socket - 2 Module - CPWS2063	2	20	1SYN880690R0002 ■	261
6/16A Socket - 2 Module - CPWS2166	2	10	1SYN880393R0001 ■	368
6/16A Socket - 3 Module - CPWS3166	3	5	1SYN880122R0001 ■	475

#### Support modules

Description	Module size	Std pack	Ordering code	Unit M.R.P. (₹)
Fan Regulator - 1 Module - CPW1SFR4	1	20	1SYN880373R0002 ■	545
Fan Regulator - CPW2SFR5	2	10	1SYN880284R0003 ■	800
Dimmer 100W - 1 Module - CPW1D0400	1	20	1SYN880373R0011	699
Dimmer 400W - CPW2D0400	2	10	1SYN880400R0001	1,078
Dimmer 1000W - CPW1D1000	2	20	1SYN880500R0001	1,286
Blank Plate - CPW1BLNK	1	80	1SYN880182R0001 ■	55
TV Socket - CPW1TVSK	1	20	1SYN880175R0001 ■	197
RJ 11TEL 2 Pin - CPW1RJ11	1	20	1SYN880192R0001 ■	160
RJ 45 Jack CAT 6 - CPW1RJ45	1	20	1SYN880201R0001 ■	789
Flex Outlet - CPW1FLEX	1	20	1SYN880165R0001	204
Foot Lamp Grid - CPW4FLGD	4	10	1SYN880671R0001	379
Buzzer - CPW2BZR	2	10	1SYN880490R0001	422
Indicator - CPW1IND	1	20	1SYN880412R0004	351

#### Hospitality products

Description	Ordering code	Unit M.R.P. (₹)
Mechanical Keytag fitted with Lumina Plate & 20A DP Switch (3M) - CPW320MKT	1SYN880669R0001	1,442
DND/MMR Set - External - CPWDNDSET	1SYN880412R0005	1,219
Switch Ste DND/MMR - Internal - CPW2SET	1SYN880414R0001	812
Room Occupied - Internal - CPW1OQP	1SYN880412R0003	546
Charger 1Module 2A - CPW1USBC	1SYN880417R0002	1,890

# Snieo

## Wiring accessories

### Snieo mounting plates

Description	Metal box size	Std Pack	Ordering code	Unit M.R.P. (₹)
1 M Plate - SNWP3301	3"x3"	25	1SYN880421R0001 ■	129
2 M Plate - SNWP3302	3"x3"	25	1SYN880422R0001 ■	129
3 M Plate - SNWP4303	4"x3"	20	1SYN880423R0001 ■	163
3 M Power Plate - SNWP4303S	4"x3"	20	1SYN880424R0001 ■	161
4 M Plate - SNWP5304	5"x3"	15	1SYN880425R0001 ■	194
5 M Plate - SNWP5305	5"x3"	15	1SYN880426R0001 ■	235
6 M Plate - SNWP8306	8"x3"	10	1SYN880427R0001 ■	315
8 M Plate - SNWP8308	8"x3"	10	1SYN880428R0001 ■	358
8 M Plate Square - SNWP5508	5"x5"	6	1SYN880430R0001 ■	393
10 M Plate - SNWP9310	9"x3"	15	1SYN880429R0001 ■	427
12 M Plate - SNWP8612	8"x6"	6	1SYN880431R0001 ■	473
16 M Plate - SNWP8616	8"x6"	6	1SYN880432R0001 ■	623

### Metal flush boxes

Description	Metal box size	Std Pack	Ordering code	Unit M.R.P. (₹)
Metal Box 1-2M - CMBZ3302	3"x3"	108	1SYN880452R0001 ■	155
Metal Box 3M - CMBZ4303	4"x3"	82	1SYN880453R0001 ■	161
Metal Box 4-5M - CMBZ5305	5"x3"	60	1SYN880454R0001 ■	204
Metal Box 6-8MH - CMBZ8308	8"x3"	40	1SYN880455R0001 ■	340
Metal Box 9-10M - CMBZ9310	9"x3"	39	1SYN880457R0001 ■	476
Metal Box 8MV - CMBZ5508V	5"x5"	26	1SYN880456R0001 ■	433
Metal Box 12-16M - CMBZ8616	8"x6"	16	1SYN880458R0001 ■	507

### Surface boxes

Description	Length	Height	Depth	Std Pack	Ordering code	Unit M.R.P. (₹)
Surface box 1-2M - SNBW3302	86.7	86.7	49.3	60	1SYN880351R0001	228
Surface box 3M - SNBW4303	115	87	50.8	45	1SYN880352R0001	257
Surface box 4M - SNBW5305	146	85.3	50.6	30	1SYN880353R0001	311
Surface box 6-8M - SNBW8308	220.3	85.9	50.5	20	1SYN880354R0001	429

## Metal Flush Boxes NEW

- New locking design form front and bottom for more strength
- Strengthening profile change to more strength of box
- New finish
- Knock out for conduit pipe entry from any direction (Top, Bottom, Side and Back)
- Possible to break open knockout without any special tool
- Optimized packaging quantity

### Metal flush boxes

Type reference and description	Number of modules	Std pack	Ordering code	Unit M.R.P.(₹)
<b>Flush boxes</b>				
Metal Box 1-2M -NM CMBZ3302	1/2	40	1SYN890452R0001 ■	140
Metal Box 3M -NM CMBZ4303	3	40	1SYN890453R0001 ■	145
Metal Box 4-5M -NM CMBZ5305	4	40	1SYN890454R0001 ■	185
Metal Box 6-8MH -NM CMBZ8308	6	40	1SYN890455R0001 ■	289
Metal Box 9-10M -NM CMBZ9310	8	40	1SYN890457R0001 ■	405
Metal Box 12-16M -NM CMBZ8616	12	10	1SYN890458R0001 ■	456

■ Stock items

# Busch-Presence detectors

## Energy saving the easy way

Presence detectors automatically detect the presence of someone inside the room. Their precision is far superior to that of conventional movement detectors. Not only lighting systems but heating systems and air-conditioning systems can be controlled intelligently and efficiently with presence detectors. Empty rooms in which the lights are on and the air-conditioning runs at full power are now history. There is one presence detector for each need.



Office single



Office open plan /  
with or without windows



Gym  
Sport facilities



Toilets



6818 U-500

Description	Type	Ordering code	L.P. (₹)
<b>Busch-Watchdog Presence tech BasicLINE mini - 6 Metres</b> For switching lighting systems that depend on brightness and movement. Ceiling installation using integrated spring bracket. Switch-off delay: approx. 1 sec - 15 min or short-time pulse adjustable.	6811 EB-500	2CKA006800A2517	7,440
<b>Busch-Watchdog Presence tech BasicLINE - 8 Metres</b> For switching lighting systems that depend on brightness and movement. For semiautomatic and fully automatic operation. Ceiling installation using integrated spring bracket. Switch-off delay: approx. 5 sec - 30 min or short-timepulse adjustable.	6814 U-500	2CKA006800A2518	6,453
<b>Busch-Watchdog Presence tech BasicLINE Corridor - 24 Metres</b> For switching lighting systems that depend on brightness and movement. Ceiling installation using included dust protection socket. Switch-off delay: approx. 10 sec - 30 min or short-time pulse adjustable. Remote control possible via IR service remote control 6843. Use outdoors possible due to combination with surfacemounted housing 6888.	6818 U-500	2CKA006800A2519	13,758
<b>Surface-mounting box -6818U</b> For Busch-Watchdog Presence tech BasicLINE Corridor 6818 U-500. For surface mounting and increase of the protection type. Protection class (Device): IP 54	6888	2CKA006899A2305	2,638

# Busch-Presence detectors

## Energy saving the easy way

Description	Type	Ordering code	L.P. (₹)
<p><b>Presence Comp. e-contact - 8 Metres</b> Master presence detector with mixed light measurement. For switching lighting systems that depend on brightness and movement. Detection range (for installation height of 3 m): circular: Seated persons: up to Ø 6,5 m, walking persons: up to Ø 8 m. Ceiling installation using integrated spring bracket. Switch-off delay: approx. 1 min - 30 min or short-time pulse adjustable. Remote control possible via IR service remote control 6843. Suitable for false ceilings with a board thickness from 9 to 25 mm.</p>	6817/62-24-500	2CKA006800A2737	25,860
 <p><b>Presence Uni. e-contact - 12 Metres</b> Master presence detector with mixed light measurement. For switching lighting systems that depend on brightness and movement. Detection range (for installation height of 3 m): circular: Seated persons: up to Ø 10 m, walking persons: up to Ø 12 m. Ceiling installation using integrated spring bracket. Switch-off delay: approx. 1 min - 30 min or short-time pulse adjustable. Remote control possible via IR service remote control 6843. Suitable for false ceilings with a board thickness from 9 to 25 mm.</p>	6817/32-24-500	2CKA006800A2739	30,911
<p><b>Presence Uni. Bluetooth e-contact - 12 Metres</b> Master presence detector with mixed light measurement. For switching lighting systems that depend on brightness and movement. Detection range (for installation height of 3 m): circular: Seated persons: up to Ø 10 m, walking persons: up to Ø 12 m. Ceiling installation using integrated spring bracket. Switch-off delay: approx. 1 min - 30 min or short-time pulse adjustable. With selectable dynamic switch-off delay. Suitable for false ceilings with a board thickness from 9 to 25 mm.</p>	6817/33-24-500	2CKA006800A2743	34,187

6817/32-24-500

Description	Type	Ordering code	L.P. (₹)
<p><b>Presence Comp. rel - 8 Meters</b> Master presence detector with mixed light measurement. For switching lighting systems that depend on brightness and movement. With power relays for LED operation. Detection range (for installation height of 3 m): circular Seated persons: up to Ø 6.5 m, walking persons: up to Ø 8 m.</p>	6819/60-24-500	2CKA006800A2733	24,141
<p><b>Presence Uni. Rel - 12 Meters</b> Master presence detector with mixed light measurement. For switching lighting systems that depend on brightness and movement. With power relays for LED operation. Detection range (for installation height of 3 m): circular Seated persons: up to Ø 10 m, walking persons: up to Ø 12 m.</p>	6819/30-24-500	2CKA006800A2735	29,438
 <p><b>Presence Uni. rel. Bluetooth - 12 Metres</b> Master presence detector with mixed light measurement. For switching lighting systems that depend on brightness and movement. With Bluetooth interface for parameterization and operation. Adjustment of all setting options via smartphone or tablet. Light control via smartphone or tablet app. With power relays for LED operation. Detection range (for installation height of 3 m): circular Seated persons: up to Ø 10 m, walking persons: up to Ø 12 m.</p>	6819/31-24-500	2CKA006800A2741	33,340
<p><b>Presence Corr. rel. Bluetooth - 20 Metres</b> Master presence detector with mixed light measurement. For switching lighting systems that depend on brightness and movement. With Bluetooth interface for parameterization and operation. Adjustment of all setting options via smartphone or tablet. Light control via smartphone or tablet app. With power relays for LED operation. Detection range (for installation height of 3 m): rectangular Walking persons: crosswise to the detector 30 m x 3 m, frontal 20 m x 3 m. Extension of the detection range by means of master/slave combination. Mounting height 27 mm.</p>	6819/51-24-500	2CKA006800A2745	43,015
<p><b>Presence Uni. DALI Bluetooth -12 Metres</b> Master presence detector with mixed light measurement. For regulating and switching of DALI operating devices that depend on brightness and movement. Suitable for up to 45 DALI operating devices. Detection range (for installation height of 3 m): circular Seated persons: up to Ø 10 m, walking persons: up to Ø 12 m.</p>	6819/35-24-500	2CKA006800A2747	41,542

6819/51-24-500

# Busch-Presence detectors

Energy saving the easy way



6819/50-24-500



6819/39-24-500



2069/21



2069/11-84

Description	Type	Ordering code	L.P. (₹)
<p><b>Presence Corr. DALI Bluetooth - 30 Metres</b> Master presence detector with mixed light measurement. For regulating and switching of DALI operating devices that depend on brightness and movement. . Detection range (for installation height of 3 m): rectangular Walking persons: crosswise to the detector 30 m x 3 m, frontal 20 m x 3 m.</p>	6819/55-24-500	2CKA006800A2749	56,087
<p><b>Presence Comp. Slave - 8 Metres</b> Slave presence detector for extension of the detection range of master presence detectors. Detection range (for installation height of 3 m): circular Seated persons: up to Ø 6.5 m, walking persons: up to Ø 8 m. Visible height 23 mm.</p>	6819/68-24-500	2CKA006800A2751	19,313
<p><b>Presence Uni. Slave - 8 Metres</b> Slave presence detector for extension of the detection range of master presence detectors. Detection range (for installation height of 3 m): circular Seated persons: up to Ø 10 m, walking persons: up to Ø 12 m. Visible height 23 mm.</p>	6819/38-24-500	2CKA006800A2753	23,555
<p><b>Presence Corr. Slave - 30 Metres</b> Slave presence detector for extension of the detection range of master presence detectors. Detection range (for installation height of 3 m): rectangular Walking persons: crosswise to the detector 24 m x 3 m, frontal/lengthways to the detector 14 m x 3 m.</p>	6819/58-24-500	2CKA006800A2755	31,796
<p><b>Presence Uni. DALI Slave - 12 Metres</b> DALI slave presence detector for extension of the detection range of DALI master presence detectors. For the supply of operating voltage via the DALI master. Power consumption on the DALI bus: max. 10 mA, corresponds to approx. 5 DALI operating devices. Detection range (for installation height of 3 m): circular Seated persons: up to Ø 10 m, walking persons: up to Ø 12 m. Visible height 23 mm.</p>	6819/39-24-500	2CKA006800A2759	30,620
<p><b>Presence Corr. DALI Slave - 30 Metres</b> DALI slave presence detector for extension of the detection range of DALI master presence detectors. For the supply of operating voltage via the DALI master. Detection range (for installation height of 3 m): rectangular Walking persons: crosswise to the detector 24 m x 3 m, frontal/lengthways to the detector 14 m x 3 m. Mounting height 27 mm.</p>	6819/59-24-500	2CKA006800A2761	31,796
<p><b>Presence Corr. Rel - 30 Metres</b> Master presence detector with mixed light measurement. For switching lighting systems that depend on brightness and movement. With power relays for LED operation. Detection range (for installation height of 3 m): rectangular Walking persons: crosswise to the detector 24 m x 3 m, frontal/lengthways to the detector 14 m x 3 m. Switch-off delay: approx. 1 min. - 30 min. or short-time pulse adjustable.</p>	6819/50-24-500	2CKA006800A2797	39,749
<p><b>IceLight set ceiling module, Busch-iceLight</b> Consisting of LED/FM insert, power module (neutral white) 2067/12 U. Consisting of ceiling module, one light direction 2068/21. For ambient lightning. Light outlet downward. Not dimmable. Light intensity can be switched between 100% and 25% using front service switch. Colour temperature: 4,000 K (neutral white) System power consumption: 5 W Rated voltage: 230 V~, + 10% / - 10% Current consumption of LED: 350 mA (secondary) Secondary: SELV</p>	2069/21	2CKA001510A0018	43,524
<p><b>IceLight Night light set, studio white, Busch-iceLight</b> Complete set consists flush-mounted LED insert Night light (cold white) 2067/14 U. Wall module with one lighting direction, design future® linear 2068/11-84. Cover frame design future® linear 1721-184K. With one lighting direction. Not dimmable. For low brightness (night light). Colour temperature 6,500 K (cold white) System power consumption: 0.15 W Rated voltage: 230 V~, + 10% / - 10% Current consumption of LED: 40 mA (secondary) Secondary: SELV</p>	2069/11-84	2CKA001510A0015	21,633

# Emergency lighting systems

## Exit sign, light and battery system

The requirement for emergency lighting originates from the Fire Precautions Act, 1971 and was further enforced by the Fire Precautions (Workplace) Regulations, 1997 (Amended 1999).

The Emergi-Lite concept is clear and simple. Emergi-Lite offers you reliable total solutions for safe evacuation. The way in which we do this is what makes the difference. Emergi-Lite offers advantages to everybody involved in the construction process. That way, you know that Emergi-Lite is always the right choice, for both you and your customers.

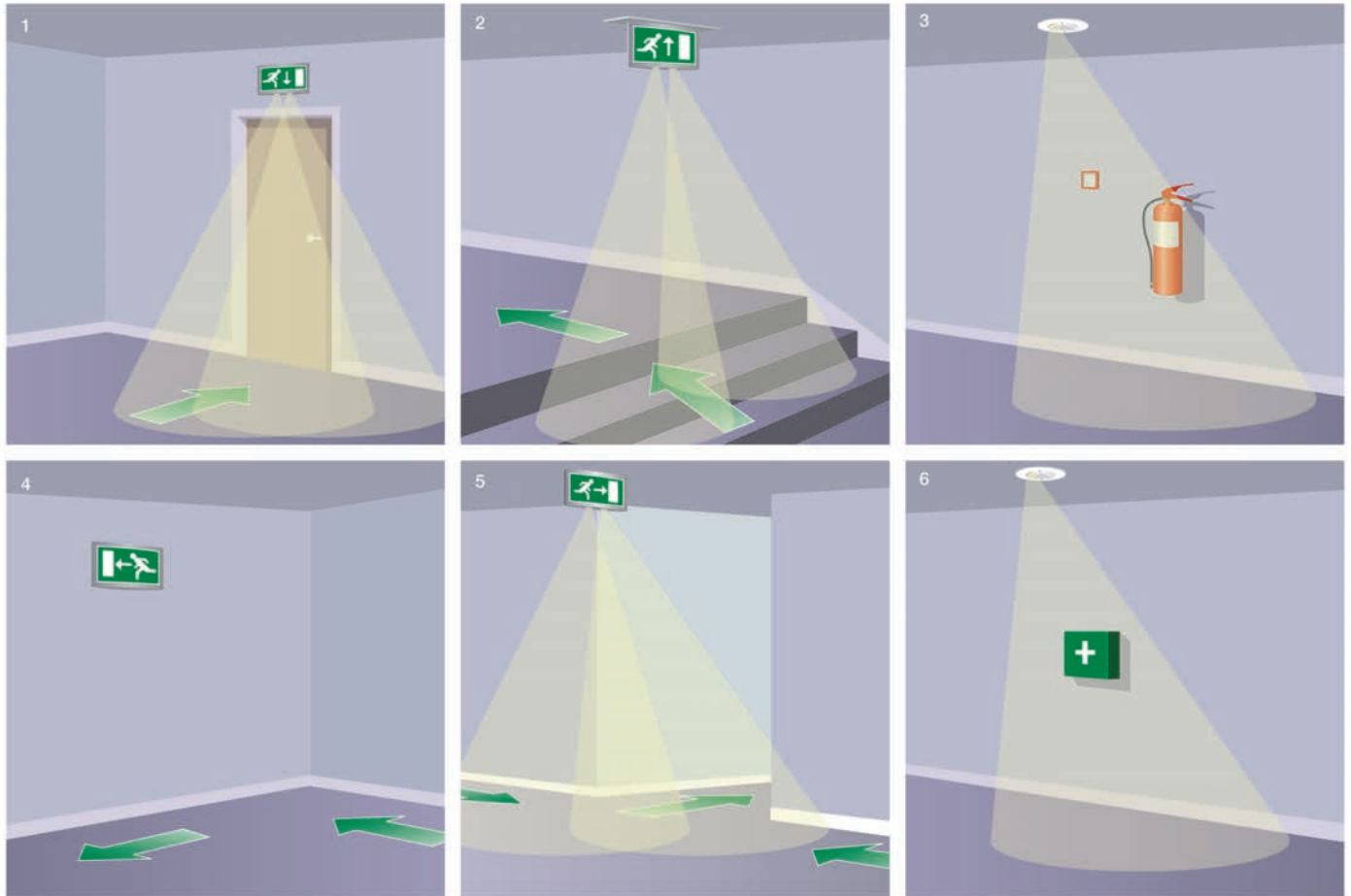

# Industrial plugs and sockets

## Wiring accessories

### Reliable, durable and safe. Perfect for your application

These products are used for connection of equipment in all kind of applications where it needs to be possible to connect and disconnect. ABB industrial plugs and sockets are chosen when safety, reliability and durability are requested.

#### IEC 60309-2 "clock"

$I_e = 16 \text{ A}, 32 \text{ A}, 63 \text{ A}, 125 \text{ A}$   
 $U_e = 50 \dots 1000 \text{ V}$

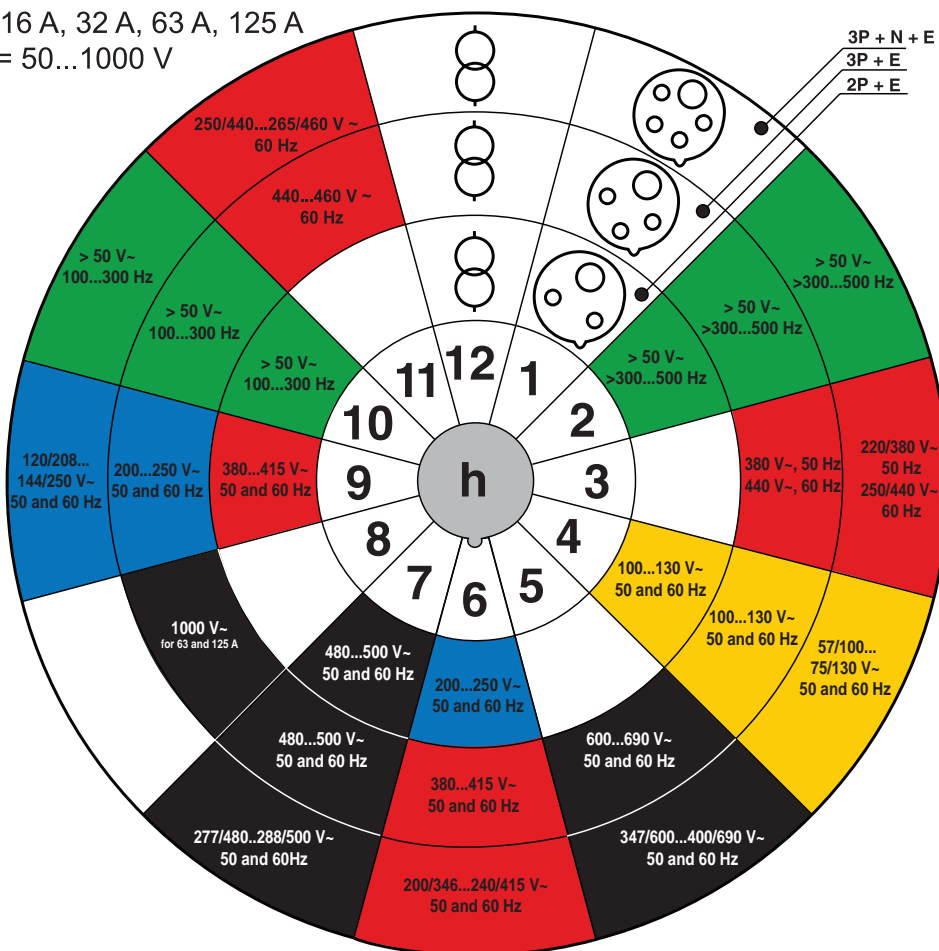

3P + N + E  
 3P + E  
 2P + E

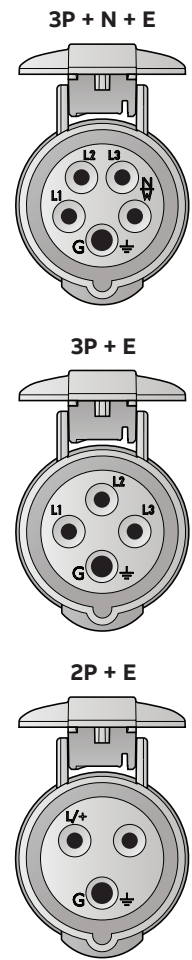

Standard voltages - Color codes according to IEC60309-1, -2

Position of earthing sleeve according to IEC 60309-2 (clock)	2P+E	3P+E	3P+N+E
1	<input type="checkbox"/> Optional voltage (not stated below)	<input type="checkbox"/> Optional voltage (not stated below)	<input type="checkbox"/> Optional voltage (not stated below)
2	<input checked="" type="checkbox"/> >300...500 V~ >50 Hz	<input checked="" type="checkbox"/> >300...500 V~ >50 Hz	<input checked="" type="checkbox"/> >300...500 V~ >50 Hz
3	<input type="checkbox"/> Not used	<input checked="" type="checkbox"/> 380 V~ 50 Hz, 440 V 60 Hz	<input checked="" type="checkbox"/> 220/380 V~ 50 Hz, 250/440 V 60 Hz
4	<input checked="" type="checkbox"/> 100...130 V~ 50 and 60 Hz	<input checked="" type="checkbox"/> 100...130 V~ 50 and 60 Hz	<input checked="" type="checkbox"/> 57/100...75/130 V~ 50 and 60 Hz
5	<input type="checkbox"/> Not used	<input checked="" type="checkbox"/> 600...690 V~ 50 and 60 Hz	<input checked="" type="checkbox"/> 347/600...400/690 V~ 50 and 60 Hz
6	<input checked="" type="checkbox"/> 200...250 V~ 50 and 60 Hz	<input checked="" type="checkbox"/> 380...415 V~ 50 and 60 Hz	<input checked="" type="checkbox"/> 200/346...240/415 V~ 50 and 60 Hz
7	<input checked="" type="checkbox"/> 480...500 V~ 50 and 60 Hz	<input checked="" type="checkbox"/> 480...500 V~ 50 and 60 Hz	<input checked="" type="checkbox"/> 277/480...288/500 V~ 50 and 60 Hz
8	<input type="checkbox"/> Not used	<input checked="" type="checkbox"/> 1000 V~ (for 63 A and 125 A)	<input type="checkbox"/> Not used
9	<input checked="" type="checkbox"/> 380...415 V~ 50 and 60 Hz	<input checked="" type="checkbox"/> 200...250 V~ 50 and 60 Hz	<input checked="" type="checkbox"/> 120/208...144/250 V~ 50 and 60 Hz
10	<input checked="" type="checkbox"/> 100...300 V~ >50 Hz	<input checked="" type="checkbox"/> 100...300 V~ >50 Hz	<input checked="" type="checkbox"/> 100...300 V~ >50 Hz
11 Mainly for marine installations	<input type="checkbox"/> Not used	<input checked="" type="checkbox"/> 440...460 V~ 60 Hz	<input checked="" type="checkbox"/> 250/440...265/460 V~ 60 Hz
12 Supply from isolating transformer	<input type="checkbox"/> Supply from isolating transformer	<input type="checkbox"/> Supply from isolating transformer	<input type="checkbox"/> Supply from isolating transformer

# Industrial plugs and sockets

## Wiring accessories

### Plugs



IP44 (2P+E)



IP44 (3P+E)



IP67 (3P+N+E)

Terminals / Pole	IP Protection	Color code	Voltage	Current rating (A)	Type	Ordering code	L.P. (₹)	
3 (2P+E)	IP44	Blue	200...250	16	216EP6	2CMA101947R1000	998	
		Blue	200...250	32	232EP6	2CMA101975R1000	1,260	
		Blue	200...250	63	263P6	2CMA166742R1000	4,975	
	IP67	Blue	200...250	16	216P6W	2CMA166460R1000	2,301	
		Blue	200...250	32	232P6W	2CMA166722R1000	2,893	
		Blue	200...250	63	263P6W	2CMA166776R1000	6,432	
		Blue	200...250	125	2125P6W	2CMA166810R1000	18,940	
		IP44	Red	380...415	16	316EP6	2CMA101956R1000	1,016
			Red	380...415	32	332EP6	2CMA101984R1000	1,394
Red	380...415		63	363P6	2CMA166752R1000	5,990		
IP67	Red		380...415	16	316P6W	2CMA166476R1000	2,303	
	Red		380...415	32	332P6W	2CMA166738R1000	3,059	
	Red		380...415	63	363P6W	2CMA166786R1000	7,083	
5 (3P+N+E)	IP44	Red	346...415	16	416EP6	2CMA101967R1000	1,190	
		Red	346...415	32	432EP6	2CMA101995R1000	1,470	
		Red	346...415	63	463P6	2CMA166764R1000	6,243	
	IP67	Red	346...415	16	416P6W	2CMA166494R1000	2,549	
		Red	346...415	32	432P6W	2CMA166524R1000	3,650	
		Red	346...415	63	463P6W	2CMA166798R1000	7,375	
		Red	346...415	125	4125P6W	2CMA166828R1000	19,712	

### Connectors



IP44 (2P+E)



IP67 (3P+E)



IP67 (3P+N+E)

Terminals / Pole	IP Protection	Color code	Voltage	Current rating (A)	Type	Ordering code	L.P. (₹)	
3 (2P+E)	IP44	Blue	200...250	16	216EC6	2CMA102003R1000	1,244	
		Blue	200...250	32	232EC6	2CMA102031R1000	1,345	
		Blue	200...250	63	263C6	2CMA166840R1000	7,205	
	IP67	Blue	200...250	16	216C6W	2CMA166538R1000	2,960	
		Blue	200...250	32	232C6W	2CMA166584R1000	3,929	
		Blue	200...250	63	263C6W	2CMA166874R1000	8,615	
		Blue	200...250	125	2125C6W	2CMA166918R1000	24,839	
		IP44	Red	380...415	16	316EC6	2CMA102012R1000	1,290
			Red	380...415	32	332EC6	2CMA102040R1000	1,798
Red	380...415		63	363C6	2CMA166850R1000	7,455		
IP67	Red		380...415	16	316C6W	2CMA166554R1000	3,368	
	Red		380...415	32	332C6W	2CMA166604R1000	3,883	
	Red		380...415	63	363C6W	2CMA166894R1000	8,775	
5 (3P+N+E)	IP44	Red	346...415	16	416EC6	2CMA102023R1000	1,465	
		Red	346...415	32	432EC6	2CMA102051R1000	2,049	
		Red	346...415	63	463C6	2CMA166862R1000	6,966	
	IP67	Red	346...415	16	416C6W	2CMA166572R1000	3,313	
		Red	346...415	32	432C6W	2CMA166618R1000	4,339	
		Red	346...415	63	463C6W	2CMA166906R1000	9,041	
		Red	346...415	125	4125C6W	2CMA166936R1000	27,608	

■ Stock items



# Industrial plugs and sockets

## Wiring accessories

### Panel mounted socket - Unified angled flange



IP44 (2P+E)



IP67 (2P+E)



IP44 (3P+E)



IP67 (3P+E)



IP44 (3P+N+E)



IP67 (3P+N+E)

Terminals / Pole	IP Protection	Color code	Voltage	Current rating (A)	Type	Ordering code	L.P. (₹)
3 (2P+E)	IP44	Blue	200...250	16	216RAU6	2CMA193218R1000	1,298
		Blue	200...250	32	232RAU6	2CMA193266R1000	1,467
		Blue	200...250	63	263RAU6	2CMA167408R1000	6,154
	IP67	Blue	200...250	16	216RAU6W	2CMA166996R1000	2,227
		Blue	200...250	32	232RAU6W	2CMA166948R1000	2,704
		Blue	200...250	63	263RAU6W	2CMA167442R1000	6,761
4 (3P+E)	IP44	Red	380...415	16	316RAU6	2CMA193226R1000	1,278
		Red	380...415	32	332RAU6	2CMA193274R1000	1,705
		Red	380...415	63	363RAU6	2CMA167418R1000	6,313
	IP67	Red	380...415	16	316RAU6W	2CMA167012R1000	2,555
		Red	380...415	32	332RAU6W	2CMA166964R1000	3,323
		Red	380...415	63	363RAU6W	2CMA167452R1000	6,765
5 (3P+N+E)	IP44	Red	346...415	16	416RAU6	2CMA193235R1000	1,471
		Red	346...415	32	432RAU6	2CMA193283R1000	1,826
		Red	346...415	63	463RAU6	2CMA167430R1000	6,241
	IP67	Red	346...415	16	416RAU6W	2CMA167030R1000	2,895
		Red	346...415	32	432RAU6W	2CMA166982R1000	3,429
		Red	346...415	63	463RAU6W	2CMA167464R1000	6,432

### Panel mounted sockets - Unified straight flange



IP44 (2P+E)



IP67 (2P+E)



IP44 (3P+E)



IP67 (3P+E)



IP44 (3P+N+E)



IP67 (3P+N+E)

Terminals / Pole	IP Protection	Color code	Voltage	Current rating (A)	Type	Ordering code	L.P. (₹)
3 (2P+E)	IP44	Blue	200...250	16	216RU6	2CMA193170R1000	1,198
		Blue	200...250	32	232RU6	2CMA193242R1000	1,344
		Blue	200...250	63	263RU6	2CMA167510R1000	5,972
	IP67	Blue	200...250	63	263RU6W	2CMA167374R1000	6,931
		Blue	200...250	125	2125RU6W	2CMA167133R1000	23,200
		Red	380...415	16	316RU6	2CMA193178R1000	1,395
4 (3P+E)	IP44	Red	380...415	32	332RU6	2CMA193250R1000	1,662
		Red	380...415	63	363RU6	2CMA167520R1000	6,173
		Red	380...415	63	363RU6W	2CMA167384R1000	6,939
	IP67	Red	380...415	125	3125RU6W	2CMA167136R1000	20,087
		Red	346...415	16	416RU6	2CMA193187R1000	1,337
		Red	346...415	32	432RU6	2CMA193259R1000	1,678
5 (3P+N+E)	IP44	Red	346...415	63	463RU6	2CMA167532R1000	6,395
		Red	346...415	63	463RU6W	2CMA167396R1000	6,957
	IP67	Red	346...415	125	4125RU6W	2CMA167142R1000	22,042

# Industrial plugs and sockets

## Wiring accessories

### Surface Sockets Outlet



IP44 (2P+E)



IP67 (2P+E)



IP44 (3P+E)



IP67 (3P+E)



IP44 (3P+N+E)



IP67 (3P+N+E) 125

Terminals / Pole	IP Protection	Color code	Voltage	Current rating (A)	Type	Ordering code	L.P. (₹)
3 (2P+E)	IP44	Blue	200...250	16	216RS6	2CMA193098R1000	1,297
		Blue	200...250	32	232RS6	2CMA193122R1000	1,769
		Blue	200...250	63	263RS6	2CMA167476R1000	6,724
	IP67	Blue	200...250	16	216RS6W	2CMA167149R1000	2,648
		Blue	200...250	32	232RS6W	2CMA167172R1000	3,770
		Blue	200...250	63	263RS6W	2CMA167306R1000	9,619
Blue		200...250	125	2125RS6W	2CMA167246R1000	29,811	
4 (3P+E)	IP44	Red	380...415	16	316RS6	2CMA193106R1000	1,454
		Red	380...415	32	332RS6	2CMA193130R1000	1,855
		Red	380...415	63	363RS6	2CMA167498R1000	6,999
	IP67	Red	380...415	16	316RS6W	2CMA167157R1000	3,200
		Red	380...415	32	332RS6W	2CMA167180R1000	4,050
		Red	380...415	63	363RS6W	2CMA167316R1000	8,478
5 (3P+N+E)	IP44	Red	346...415	16	416RS6	2CMA193115R1000	1,499
		Red	346...415	32	432RS6	2CMA193139R1000	1,911
		Red	346...415	63	463RS6	2CMA167484R1000	7,035
	IP67	Red	346...415	16	416RS6W	2CMA167166R1000	3,436
		Red	346...415	32	432RS6W	2CMA167189R1000	4,475
		Red	346...415	63	463RS6W	2CMA167328R1000	8,569
		Red	346...415	125	4125RS6W	2CMA167264R1000	27,670

# Installation products

## Product brands overview

The acquisition of Thomas & Betts advances ABB's strategy of expanding its electrification products division into new geographies, sectors and products. The combination of Thomas & Betts' electrical components and ABB's low voltage protection, control and measurement products offer more of the components you need every day than any other single manufacturer in the world.

Our focus is on improving your business performance by providing practical, reliable electrical products and services that solve everyday problems in:

- Wire & cable management - cable ties, wiring ducts, accessories.
- Connectivity & grounding - connectors, terminals, earthing, lightning protection
- Cable protection systems - rigid and flexible conduit & fittings
- Lighting & systems - emergency lighting, lighting & battery systems
- Explosion protection - IECex, UL, CSA lighting, boxes and conduit systems
- Cable accessories and apparatus - MV and HV switches, cable accessories

Markets we protect & connect together.

- 1 Renewables  
Wind, solar, water & bio
- 2 Utilities  
Power generation, transmission & distribution, telecom & datacentre, water & waste
- 3 Extraction  
Oil, gas, mining
- 4 Transportation & infrastructure  
Rail, road, marine, aerospace, rail track, motorways, waterways
- 5 Commercial & institutional  
Office & storage, retail & leisure, healthcare & education, Government
- 6 Residential  
Residential towers & apartment blocks, housing development projects, HMOs & university accommodation
- 7 Industry processing chemicals, pharma, minerals, metals, materials, food & beverage, agriculture
- 8 Industry assembling & OEM  
OEM equipment & devices, machinery, automation, robotics

Wire & cable management - Energy & data connection	Cable protection systems - Energy & data protection	Connectivity & grounding - Critical process protection	Lighting - Safety & explosion proof
 <p><b>Ty-Rap</b></p> <p>Premium cable ties</p>	 <p><b>Flexiplast</b></p> <p>Flexible conduit systems for critical power &amp; data protection</p>	 <p><b>furse</b></p> <p>Earthing &amp; lightning protection</p>	 <p><b>EMERGI-LITE</b></p> <p>Emergency lighting systems</p>
 <p><b>Ty-Met</b></p> <p>Stainless steel cable ties</p>	 <p><b>Flexiplast</b></p> <p>Flexible conduit systems for hazardous areas</p>	 <p><b>elastimold</b></p> <p>Underground cable protection accessories</p>	 <p><b>EMERGI-LITE</b></p> <p>Emergency safety systems</p>
 <p><b>T&amp;B Cable Tray</b></p> <p>Cable tray, ladder, support systems &amp; wire duct</p>	 <p><b>PMA</b></p> <p>Cable protection systems</p>	 <p><b>JOSLYN</b></p> <p>Overhead products for electrical power systems</p>	 <p><b>BTS</b></p> <p>Explosion-proof lighting &amp; emergency lighting</p>
 <p><b>E-Klips</b></p> <p>Electrical &amp; mechanical steel spring fasteners</p>	 <p><b>Harnessflex</b></p> <p>Automotive wiring harness protection</p>	 <p><b>Spec-Konr</b></p> <p>Solderless crimp connectors</p>	 <p><b>BTS</b></p> <p>Custom built control panels for hazardous areas</p>

# Flexible conduit system

## Adaptaflex flexible conduit system

Adaptaflex is one of the market leading flexible conduit system brands that can be found all over the world. Combining innovative design with dedicated manufacture, it offers customers one of the world's broadest ranges of cable protection products and solutions. With a choice of over 6000 products, the range covers metallic and non-metallic flexible conduit systems for the protection of critical power and data cables.

The system solutions from Adaptaflex need to perform in a wide variety of environments from high temperature to freezing subzero conditions. The products are designed and tested to withstand constant vibrations, water ingress, offer corrosion resistance and are available in halogen free, low smoke and low toxicity materials. An extensive range of engineered solutions are designed to withstand the rigours of some of the most technically demanding markets. So whatever your project involves, our experience will provide the answer, helping you to specify the correct flexible conduit system.

## Markets and industries

Adaptaflex flexible conduit systems used to protect critical power and data cabling are available throughout a wide range of markets including:

- Commercial contracting
- Machinery
- Rail / Infrastructure
- Marine
- Mechanical
- Security / CCTV
- Data cabling
- Critical power

Many components are designed specifically for a market solution. These products uniquely meet an industry's needs - solving a specific application requirement, providing product innovation, saving installation and component costs, improving the quality and the integrity of the end product. Wherever you need mechanical and electrical protection for your cables you can be confident in specifying Adaptaflex products.

## Type PA - Polyamide (Nylon) 6 conduit

Type Code	Description	UOM	MOQ	SPQ	M.R.P.*
PAFL13/BL	13mm nominal dia Nylon conduit, black	mtr	50	50	Upon request
PAFL16/BL	16mm nominal dia Nylon conduit, black	mtr	50	50	
PAFL21/BL	21mm nominal dia Nylon conduit, black	mtr	50	50	
PACL28/BL	28mm nominal dia Nylon conduit, black	mtr	50	50	
PACL34/BL	34mm nominal dia Nylon conduit, black	mtr	50	50	
PACL42/BL	42mm nominal dia Nylon conduit, black	mtr	25	25	
PACL54/BL	54mm nominal dia Nylon conduit, black	mtr	25	25	
PACS80/BL	80mm nominal dia Nylon conduit, black	mtr	10	10	
PACS106/BL	106mm nominal dia Nylon conduit, black	mtr	10	10	

\* Price per meter



### Approvals



### Temperature Range

Static applications: -40°C to +120°C

Moving applications: -5°C to +120°C

### Flexibility & fatigue life

High flexibility - high fatigue life

### Fire performance & EMI screen

Self extinguishing Halogen-free

### UV resistance

Very high

## Type S - Galvanised steel general purpose conduit

Type Code	Description	UOM	MOQ	SPQ	M.R.P.*
S16	16mm nominal dia steel conduit	mtr	10	10	Upon request
S20	20mm nominal dia steel conduit	mtr	10	10	
S25	25mm nominal dia steel conduit	mtr	10	10	
S32	32mm nominal dia steel conduit	mtr	10	10	
S40	40mm nominal dia steel conduit	mtr	10	10	
S50	50mm nominal dia steel conduit	mtr	10	10	
S63	63mm nominal dia steel conduit	mtr	10	10	
S75	75mm nominal dia steel conduit	mtr	10	10	

\* Price per meter



### Approvals



### Temperature range

Static applications: -50°C to +300°C

Moving applications: -45°C to +250°C

### Flexibility & fatigue life

High flexibility - High fatigue life

### Fire performance & EMI screen

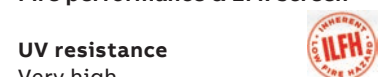

### UV resistance

Very high

## Type SP - Covered steel general purpose conduit

Type Code	Description	UOM	MOQ	SPQ	M.R.P.*
SP16/BL	BL 16mm nom. dia covered steel conduit, black	mtr	10	10	Upon request
SP20/BL	20mm nom. dia covered steel conduit, black	mtr	10	10	
SP25/BL	25mm nom. dia covered steel conduit, black	mtr	10	10	
SP32/BL	32mm nom. dia covered steel conduit, black	mtr	10	10	
SP40/BL	40mm nom. dia covered steel conduit, black	mtr	10	10	
SP50/BL	50mm nom. dia covered steel conduit, black	mtr	10	10	
SP63/BL	63mm nom. dia covered steel conduit, black	mtr	10	10	
SP75/BL	75mm nom. dia covered steel conduit, black	mtr	10	10	

\* Price per meter



### Approvals



### Temperature range

Static applications: -25°C to +70°C

Moving applications: -5°C to +90°C

### Flexibility & fatigue life

High flexibility - Medium fatigue life

### Fire performance & EMI screen

Self extinguishing

### UV resistance

Very high

For any other specification/requirement of conduits and accessories kindly contact local ABB sales office

# External lightning protection

## OPR - Optimized Pulse Rod

### The OPR efficiency ( $\Delta T$ )

Lightning is one of the most spectacular meteorological phenomena. Generated by the interaction of clouds elements (water and ice), it can kill, injure and damage. The unique efficiency of the OPR Early streamer emission is based on the difference ( $\Delta T$ ), measured in a laboratory, in between the emission time of the OPR and the one from a simple rod. The OPR ESE air terminal is composed of a striking point connected to a down conductor to conduct the lightning to the ground.

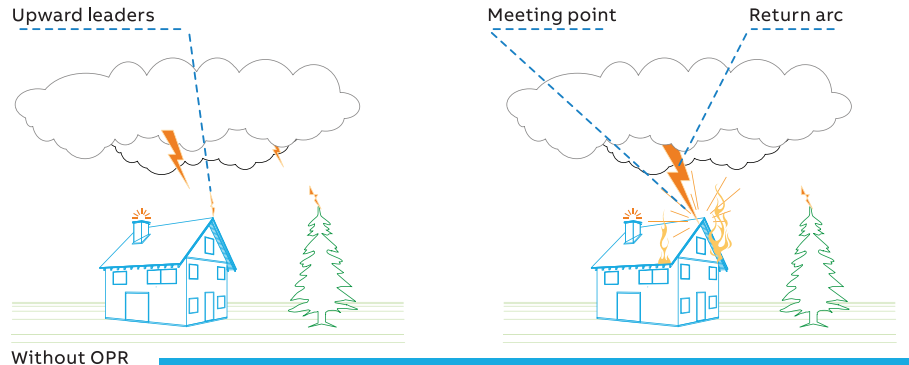

### Complete autonomy

During a storm the ambient electric field may rise from 600 V to 10-20 kV/m. When the electric field reach this level representing a minimum risk for a lightning, the OPR begins to get activated and generates high voltage pulses, helping to create and propagating an upward leader. After a strike on the OPR, the lightning current is driven to ground by the down conductor to the earth termination system.

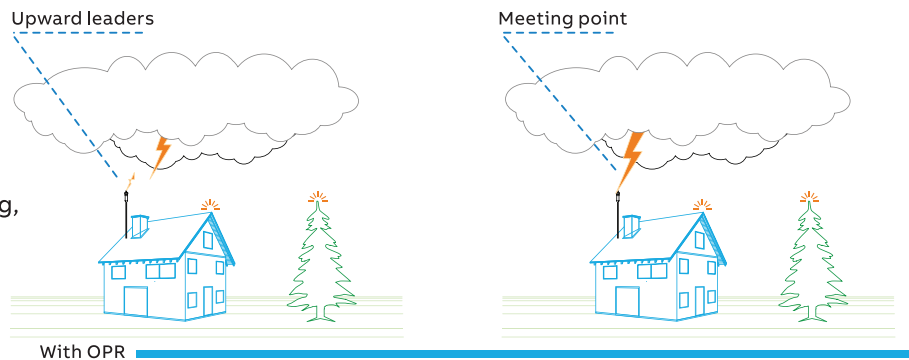

### Radius of protection

The radius of protection ( $R_p$ ) of the OPR is calculated according to the NF C 17-102 (edition 2011). It depends on the OPR efficiency ( $\Delta T$ ) expressed in micro-seconds. The maximum value for  $\Delta T$  is 60  $\mu s$ .

The risk assessment shall be calculated according to the NF C 17-102 Annex A / IEC 62305-2 and will define the protection level (LPL I, II, III or IV) which will be used in the determination of the OPR radius of protection.

### Installing/testing

The installation and verification of lightning protection systems using one or more OPR units must be performed in accordance with the manufacturer's recommendations and to the NF C 17-102 standard.

**Rp(h)** : Protection radius at a given height (h)  
 $R_p(h) = \sqrt{2rh - h^2 + \Delta(2r + \Delta)}$  (for  $h \geq 5$  m)  
 For  $h < 5$  m, refer to the table below

**h** : Height of the OPR tip above the surface(s) to be protected

**r(m)** : Standardized striking distance

**$\Delta(m)$**  =  $10^6 \cdot \Delta T$  (OPR efficiency)

### OPR radius of protection

Protection level	I (r = 20 m)			II (r = 30 m)			III (r = 45 m)			IV (r = 60 m)		
	OPR 30	OPR 45	OPR 60	OPR 30	OPR 45	OPR 60	OPR 30	OPR 45	OPR 60	OPR 30	OPR 45	OPR 60
<b>h (m)</b>	<b>Radius of protection Rp (m)</b>											
2	19	25	31	22	28	35	25	32	39	28	36	43
3	29	38	47	33	42	52	38	48	58	43	57	64
4	38	51	63	44	57	69	51	65	78	57	72	85
<b>5</b>	<b>48</b>	<b>63</b>	<b>79</b>	<b>55</b>	<b>71</b>	<b>86</b>	<b>63</b>	<b>81</b>	<b>97</b>	<b>71</b>	<b>89</b>	<b>107</b>
6	48	63	79	55	71	87	64	81	97	72	90	107
8	49	64	79	56	72	87	65	82	98	73	91	108
10	49	64	79	57	72	88	66	83	99	75	92	109
15	50	65	80	58	73	89	69	85	101	78	95	111
20	50	65	80	59	74	89	71	86	102	81	97	113
45	43	65	76	58	75	89	75	90	105	89	104	119
50	40	65	74	57	75	88	75	90	105	89	104	120
55	36	65	72	55	75	86	74	90	105	90	105	120
60	30	65	69	52	75	85	73	90	104	90	105	120

# External lightning protection

## OPR - Optimized Pulse Rod

### OPR Range

Type Code	Description	Length (m)	Weight (kg)	Time gain (μs)	Ordering code	M.R.P. (₹)
OPR 30	ESE Air terminal without mast	0.215	2.4	30	2CTB899800R7000	Upon request
OPR 45	ESE Air terminal without mast	0.215	2.4	45	2CTB899800R7500	
OPR 60	ESE Air terminal without mast	0.215	2.4	60	2CTB899800R7100	

### Accessories

Type Code	Description	Length (m)	Weight (kg)	Ordering code	M.R.P. (₹)
LS COUNTER	Lightning stroke counter	-	0.56	2CTH0CCF2004	Upon request
MAST 2M30	Mounting Mast, 2m, 30mm dia	2	4.4	H00003002L	
MAST 3M	Mounting Mast, 3m with guywire and base plate	3	6.5	H00003003LGB	
CM015	25kg sack of bentonite moisture	-	25	7TCA083870R0030	
CM035	25kg sack of furse conductive	-	25	7TCA083870R1818	
RB335	3/4 (NOM)x3000mm extensible cu-bond	3	-	7TCA083120R0069	
CR315	1in (25mm) type e connector	-	-	7TCA083210R0014	
PT205	Lockable high performance poly	-	-	7TCA083320R0011	
TC030/50-IN	25x3mm cu-tape 50m furse coils	50	-	7TCA083010R0629	

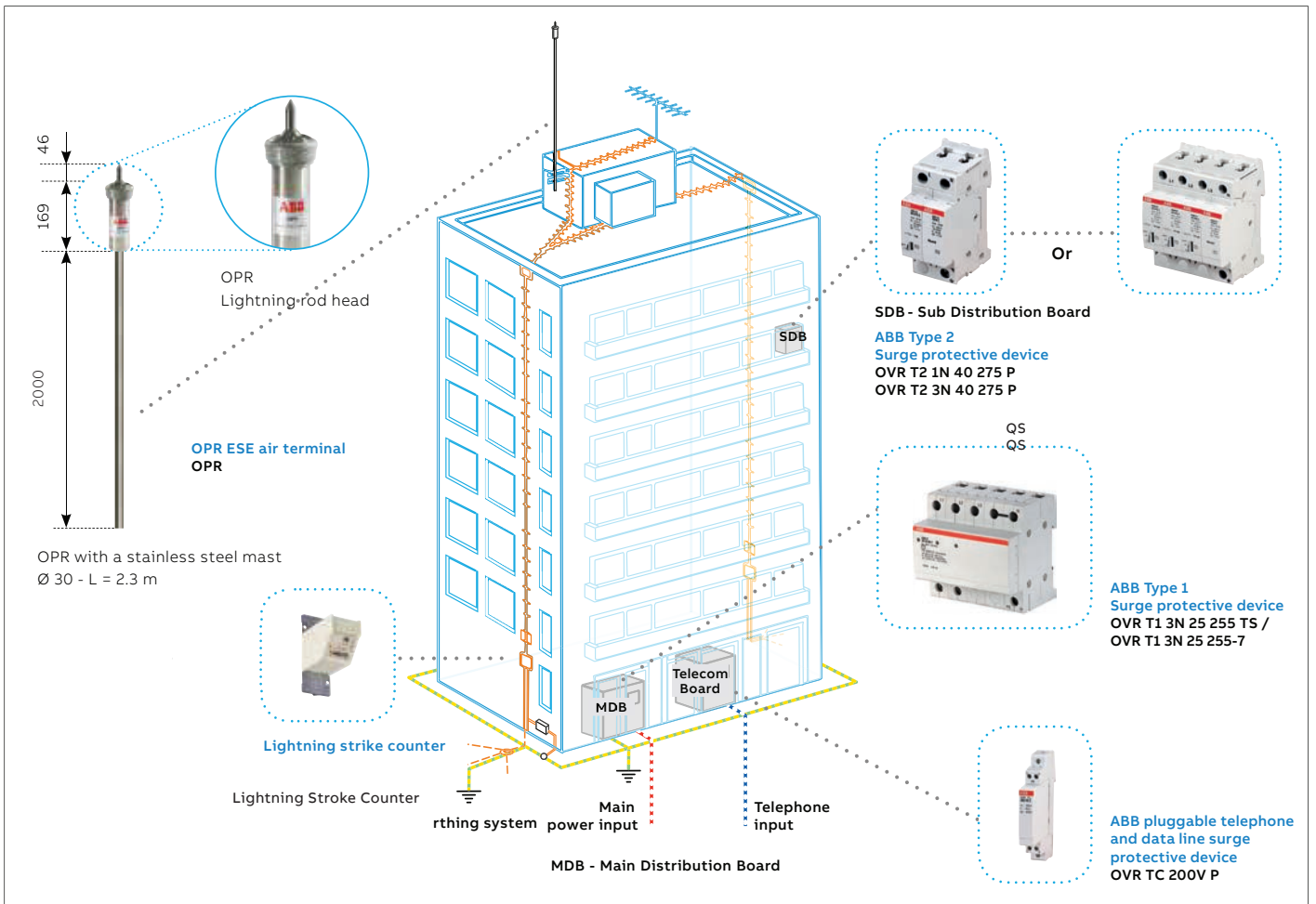

# External lightning protection

## Furse - Earthing and lightning protection

Furse provides world leading earthing, lightning and electronic systems protection from our own designed and manufactured products through to risk assessment and systems design advice.

Our renowned Furse range of earthing & lightning protection design services provide a unique total solution.

### Expertise

Specialist advice from our fully qualified technical engineers - focusing on your earthing & lightning protection issues and concerns.

### Experience

Experience to provide the optimum design - one that doesn't use more material than is necessary, saving you money.

### Knowledge

Our knowledge of the latest products ensures a tailored design that can be installed using the most appropriate and up-to-date products.



### Structural lightning protection

From Furse air termination systems including air rods and strike plates to capture lightning strikes, through to our comprehensive range of down conductors and lightning protection components which channel lightning energy safely to a Furse earth termination network.

- Air termination systems
- Lightning protection conductors
- Conductor clips, clamps and holdfasts
- Bimetallic connection components



### Electronic systems protection

Our exhaustive range of equipotential bonding and transient overvoltage SPDs providing fully co-ordinated protection against transient overvoltages on all incoming and outgoing metallic service lines including power, data, signal & telecoms.

- Lightning equipotential bonding SPDs
- Mains power transient overvoltage SPDs
- Data, signal & telecommunication lines SPDs
- DC power & photovoltaic SPDs

### Compliance, now & in the future

Furse designs comply with all recognised standards - national and international. Our engineers actively contribute to national and harmonised European / international standards, ensuring we remain at the forefront of new developments.

- BS EN/IEC 62305 protection against lightning
- NFPA 780 Standard for the installation of lightning protection systems
- IEEE Std 80:2000 IEEE guide for safety in AC substation grounding
- ENA TS 41-24 guidelines for the design, installation, testing & maintenance of main earthing systems in substations
- BS EN 50522:2010 - earthing of power installations exceeding 1.k Vac
- IS/IEC 62305 - protection against lightning



### Earthing

A combination of Furse earth electrodes, soil conditioning, conductors and equipotential bonding bars provide an effective, low resistance dissipation from the lightning protection system to earth.

- Earth rods and conductor systems
- Mechanical earth clamps and bonds
- Soil conditioning agents
- Earth bars and equipotential bonding



### FurseWELD - Exothermic welding

FurseWELD exothermic welding is a cost-efficient, self-contained system that uses the high temperature reaction of powdered copper oxide and aluminium, within a mould, to form permanent electrical connections.

- Moulds
- Powder
- Handle clamps
- Accessories

## Section I: Auxiliary relays, tripping relays and timers

Type	Technical description	Auxiliary voltage	Type of mounting	Contact configurations	Typical applications	L.P. (₹)
<b>Auxiliary relays</b>						
CV2DJ	Single element auxiliary relay, self reset contacts with operation indicator	24/30/48/110/220/250 V DC	Flush mounting	2NO+0NC/ 1NO+1NC	Contact multiplication, signalling	2,230
CV2AJ	Single element auxiliary relay, self reset contacts with operation indicator	110/240 V AC	Flush mounting	2NO+0NC/ 1NO+1NC	Contact multiplication, signalling	3,230
CV2D2J	Two element auxiliary relay, self reset contacts with operation indicator	24/30/48/110/220/250 V DC	Flush mounting	4NO+0NC/ 2NO+2NC/ 3NO+1NC	Contact multiplication, signalling	3,530
CV2A2J	Two element auxiliary relay, self reset contacts with operation indicator	110/240 V AC	Flush mounting	4NO+0NC/ 2NO+2NC/ 3NO+1NC	Contact multiplication, signalling	3,860
P8nCH2J	Single element auxiliary relay, self reset contacts with operation indicator	24/30/48/110/125//220/250 V DC	Flush mounting	7NO+0NC/ 6NO+1NC/ 5NO+2NC/ 4NO+3NC	Contact multiplication, signalling and tripping	4,290
P8nCH2J	Single element auxiliary relay, self reset contacts without operation indicator	110/240 V AC	Flush mounting	7NO+0NC/ 6NO+1NC/ 5NO+2NC/ 4NO+3NC	Contact multiplication, signalling and tripping	4,790
P8nAHX	Single element auxiliary relay, self reset contacts without operation indicator	24/30/48/110/125//220/250 V DC	Plug-in base mounting	7NO+0NC/ 6NO+1NC/ 5NO+2NC/ 4NO+3NC	Contact multiplication, signalling and tripping	4,730
RXP8n	Single element auxiliary relay, self reset contacts without operation indicator	24/30/48/110/220/250 V DC	Combiflex mounting*	7NO+0NC/ 6NO+1NC/ 5NO+2NC/ 4NO+3NC	Contact multiplication, signalling and tripping	3,880
<b>Supervision relays</b>						
PN8nCH2J	No volt relay with reverse flag, self reset contacts	24/30/48/110/220 V DC	Flush mounting	7NO+0NC/ 6NO+1NC/ 5NO+2NC/ 4NO+3NC	DC supply supervision	4,265
PN8nCH2J	No volt relay with reverse flag, self reset contacts	110/240 V AC	Flush mounting	7NO+0NC/ 6NO+1NC/ 5NO+2NC/ 4NO+3NC	AC supply supervision	4,645
TCS	Trip circuit supervision relay	24/30/48 V DC 110-125/220-250 V DC/AC	Flush mounting	1NO+1NC+2C/O	Trip circuit supervision	5,940
RXTCS	Trip circuit supervision relay	24/30/48 V DC 110-125/220-250 V DC/AC	Combiflex mounting*	1NO+1NC+2C/O	Trip circuit supervision	6,040
UVT92M	Fuse failure relay	110V AC, 50 Hz, 30/110/220 V DC	Flush mounting		Fuse failure supervision	13,760

\*Combiflex accessories need to be ordered separately. Check with your local ABB office.



## Section II: Electro-mechanical high speed tripping relays, Bi-stable relays and static relays

Type	Technical description	Auxiliary voltage	Type of mounting	Contact configurations	Typical applications	L.P. (₹)
<b>High speed tripping relays</b>						
PQ5nCH2J	High speed tripping relay, hand reset contacts with operation indicator	24/30/48/110/125//220/250 V DC	Flush mounting	4NO+0NC/ 3NO+1NC	Low burden tripping	4,115
PQ5nCH2J	High speed tripping relay, hand reset contacts with operation indicator	110/240 V AC	Flush mounting	4NO+0NC/ 3NO+1NC	Low burden tripping	4,650
PQ8nCH2J	High speed tripping relay, hand reset contacts with operation indicator	24/30/48/110/125//220/250 V DC	Flush mounting	7NO+0NC/ 6NO+1NC/ 5NO+2NC/ 4NO+3NC	Low burden tripping	4,700
PQ8nCH2J	High speed tripping relay, hand reset contacts with operation indicator	110/240 V AC	Flush mounting	7NO+0NC/ 6NO+1NC/ 5NO+2NC/ 4NO+3NC	Low burden tripping	5,075
PQ8nC2JW	High speed high burden tripping relay, hand reset contacts with operation indicator	24-30/48/110-125//220-250 V DC	Flush mounting	6NO+0NC/ 5NO+1NC/ 4NO+2NC	High burden tripping	4,700
RXPQ8n	High speed tripping relay, hand reset contacts with operation indicator	24/30/48/110/220/250 V DC	Combiflex mounting*	7NO+0NC/ 6NO+1NC/ 5NO+2NC/ 4NO+3NC	Low burden tripping	3,980
PSU14n-2X	High speed tripping relay, electrically reset contacts, with operation indicator	110/220 V DC	Plug-in base mounting	14NO+0NC/ 13NO+1NC/ 12NO+2NC/ 11NO+3NC/ 10NO+4NC/ 9NO+5NC/ 8NO+6NC/ 7NO+7NC	High burden tripping	14,210
RXPSU14n	High speed tripping relay, electrically reset contacts with operation indicator	110/220 V DC	Combiflex mounting*	14NO+0NC/ 13NO+1NC/ 12NO+2NC/ 11NO+3NC/ 10NO+4NC/ 9NO+5NC/ 8NO+6NC/ 7NO+7NC	High burden tripping	14,210
PSU6n-X	High speed trip relay without operation indicator	110/220 V DC	Plug-in base mounting	6NO+0NC 5NO+1NC 4NO+2NC 3NO+3NC	High burden tripping	8,630
RXPSU6n	High speed trip relay without operation indicator	110/220 V DC	Combiflex mounting*	6NO+0NC 5NO+1NC 4NO+2NC 3NO+3NC	High burden tripping	8,630
PSU14nCJW	High speed high burden tripping relay, hand/ electrical reset contacts with operation indicator	110/220 V DC	Flush Mounting	14NO+0NC 13NO+1NC/ 12NO+2NC/ 11NO+3NC/ 10NO+4NC/ 9NO+5NC/ 8NO+6NC/ 7NO+7NC	High burden tripping	15,240
PSU6nCJW	High speed high burden tripping relay, hand/ electrical reset contacts with operation indicator	110/220 V DC	Flush Mounting	6NO+0NC 5NO+1NC/ 4NO+2NC/ 3NO+3NC	High burden tripping	9,240

## Section II: Electro-mechanical high speed tripping relays, Bi-stable relays and static relays

Type	Technical description	Auxiliary voltage	Type of mounting	Contact configurations	Typical applications	L.P. (₹)
<b>Bi-stable relays</b>						
PSU6n-X	Bi-stable relay, electrically reset contacts without operation indicator	24/30/48/110/125//220/250 V DC	Plug-in base mounting	6NO+0NC/ 5NO+1NC/ 4NO+2NC/ 3NO+3NC	CB/ Isolation/ Earth switch/ Contact multiplication/ Voltage selection/ CT switching	7,785
PSU14n-2X	Bi-stable relay, electrically reset contacts with operation indicator	24/30/48/110/125//220/250 V DC	Plug-in base mounting	14NO+0NC/ 13NO+1NC/ 12NO+2NC/ 11NO+3NC/ 10NO+4NC/ 9NO+5NC/ 8NO+6NC/ 7NO+7NC	CB/ Isolation/ Earth switch/ Contact multiplication/ Voltage selection/ CT switching	12,840
RXPSU6n	Bi-stable relay, electrically reset contacts without operation indicator	24/30/48/110/125//220/250 V DC	Combiflex mounting*	6NO+0NC/ 5NO+1NC/ 4NO+2NC/ 3NO+3NC	CB/ Isolation/ Earth switch/ Contact multiplication/ Voltage selection/ CT switching	7,785
RXPSU14n	Bi-stable relay, electrically reset contacts, with operation Indicator	24/30/48/110/125//220/250 V DC	Combiflex mounting*	14NO+0NC/ 13NO+1NC/ 12NO+2NC/ 11NO+3NC/ 10NO+4NC/ 9NO+5NC/ 8NO+6NC/ 7NO+7NC	CB/ Isolation/ Earth switch/ Contact multiplication/ Voltage selection/ CT switching	12,840
<b>Static protection relay</b>						
IRXm	Circulating current relay	24/30/48 V DC 110-125/220-250 V DC	Flush mounting	2NO+1NC	Restricted earth fault protection for generators and transformers, high impedance differential protection for motors, generators	14,415
VHXM22A	Under relay without time delay	63.5/110/240 V AC, 40-80%, 24/30/48/110/220 V DC	Flush mounting	6NO+0NC/ 3NO+3NC/	Under voltage protection/ Residual (dead bus) monitoring	12,740
VHXM22B	Under voltage relay with variable time delay	63.5/110/240 V AC, 40-80%, 0.1-1.0 sec/0.5-5.0 sec/1-10 sec, 24/30/48/110/220 V DC	Flush mounting	6NO+0NC/ 3NO+3NC/	Under voltage protection	17,510
VHXM23A	Over voltage relay without time delay	63.5/110/240 V AC, 80-140%, 24/30/48/110/220 V DC	Flush mounting	6NO+0NC/ 3NO+3NC/	Over voltage relay	12,740
VHXM23B	Over voltage relay with variable time delay	63.5/110/240 V AC, 80-140%, 0.1-1.0 sec/0.5-5.0 sec/1-10 sec, 24/30/48/110/220 V DC	Flush mounting	6NO+0NC/ 3NO+3NC/	Over voltage relay	17,510

\*Combiflex accessories need to be ordered separately. Check with your local ABB office.

# Type 2 co-ordination

## MS132/MS165 DOL-NS-IE1/IE2/IE3

SCPD type : MMS

Rated voltage : 400/415 V.

Short circuit current: 50 kA

Starting type : DOL-NS

Co-ordination type: IEC Type 2

Overload relay: embedded

Frequency: 50-60 Hz

Motor			Manual motor starter		Contactor
Rated power	Rated current		Instantaneous tripping current	Current setting range	
[kW]	[A]	Type	[A]	[A]	Type
0.06	0.2	MS132-0,25	2.44	0.16 - 0.25	
0.09	0.3	MS132-0,40	3.9	0.25 - 0.40	
0.12	0.44	MS132-0,63	6.14	0.40 - 0.63	
0.18	0.6	MS132-0,63	6.14	0.40 - 0.63	
0.25	0.85	MS132-1,0	11.5	0.63 - 1.00	
0.37	1.1	MS132-1,6	18.4	1.00 - 1.60	
0.55	1.5	MS132-1,6	18.4	1.00 - 1.60	
0.75	1.9	MS132-2,5	28.75	1.60 - 2.50	
1.1	2.7	MS132-4,0	50	2.50 - 4.00	
1.5	3.6	MS132-4,0	50	2.50 - 4.00	
2.2	4.9	MS132-6,3	78.75	4.00 - 6.30	
3	6.5	MS132-10	150	6.30 - 10.00	
4	8.5	MS132-10	150	6.30 - 10.00	
5.5	11.5	MS132-12	180	8.00 - 12.00	
7.5	15.5	MS132-16	240	10.00 - 16.00	
11	22	MS132-25	375	20.00 - 25.00	
15	29	MS132-32	480	25.00 - 32.00	
18.5	35	MS165-42	630	30.00 - 42.00	
22	41	MS165-54	810	40.00 - 54.00	
25	46.6	MS165-54	810	40.00-54.00	
30	45.5	MS165-65	975	52.00-65.00	

# Type 2 co-ordination

## MS132/MS165 SD-NS-IE1/IE2/IE3

Co-ordination type: IEC Type 2

SCPD type: MMS

Rated voltage : 400/415 V

Short circuit current: 50 kA.

Starting type : SD-NS

Overload relay: Embedded

Frequency : 50-60 Hz

Rated power [kW]	Rated current		Instantaneous tripping current [A]	Current setting range			
	[A]	Type		[A]	Line	Delta	Star
0.06	0.20	MS132-0,25	3.13	0.16 - 0.25	A9	A9	A9
0.09	0.30	MS132-0,40	5.0	0.25 - 0.40	A9	A9	A9
0.12	0.44	MS132-0,63	7.88	0.40 - 0.63	A9	A9	A9
0.18	0.60	MS132-0.63	7.88	0.40 - 0.63	A9	A9	A9
0.25	0.85	MS132-1,00	12.5	0.63 - 1.00	A9	A9	A9
0.37	1.10	MS132-1,60	20.0	1.00 - 1.60	A9	A9	A9
0.55	1.50	MS132-1,60	20.0	1.00 - 1.60	A9	A9	A9
0.75	1.90	MS132-2,50	31.25	1.60 - 2.50	A9	A9	A9
1.1	2.70	MS132-4,00	50	2.50 - 4.00	A26	A26	A26
1.5	3.60	MS132-4,00	50	2.50 - 4.00	A26	A26	A26
2.2	4.90	MS132-6,30	78.75	4.00 - 6.30	A26	A26	A26
3.0	6.5	MS132-10.00	150	6.30-10.00	A26	A26	A26
4.0	8.5	MS132-10.00	150	6.30-10.00	A26	A26	A26
5.5	11.5	MS132-16.00	240	10.00-16.00	A26	A26	A26
7.5	18.5	MS132-20.00	300	16.00-20.00	A30	A26	A26
11.0	22.0	MS132- 25.00	375	20.00-25.00	A30	A26	A26
15.0	29.0	MS132- 32.00	480	25.00-32.00	A30	A26	A26
15.0	29.0	MS165 -32.00	480	23.00-32.00	A40	A40	A40
18.5	35.0	MS165 -42.00	630	30.00-42.00	A40	A40	A40
22.0	41.0	MS165 -54.00	810	40.00-54.00	A50	A40	A40
25.0	46.6	MS165 -54.00	810	40.00-54.00	A63	A40	A40
30.0	55.0	MS165 -65.00	975	52.00-65.00	A63	A40	A40

# Type 2 co-ordination

## MCCB DOL-NS

SCPD type: MCCB

Rated voltage: 400/415 V

Short circuit current: 50 kA

Starting type: DOL-NS

Coordination type: IEC Type 2 / IE1 /IE2

Overload relay: TOL

Frequency: 50-60 Hz

Motor		Moulded case circuit breakers		Contactor		Overload relay
Rated power	Rated current	Instantaneous tripping current				Current setting range
[kW]	[A]	Type	[A]	Type	Type	[A]
0.37	1.1	XT2S160 MF 2	28	A9	TA25DU1.4	1 - 1.4
0.55	1.5	XT2S160 MF 2	28	A9	TA25DU1.8	1.3 - 1.8
0.75	1.9	XT2S160 MF 2	28	A9	TA25DU2.4	1.7 - 2.4
1.1	2.7	XT2S160 MF 4	56	A9	TA25DU4	2.8 - 4
1.5	3.6	XT2S160 MF 4	56	A16	TA25DU5	3.5 - 5
2.2	4.9	XT2S160 MF 8.5	120	A26	TA25DU6.5	4.5 - 6.5
3	6.5	XT2S160 MF 8.5	120	A26	TA25DU8.5	6 - 8.5
4	8.5	XT2S160 MF 12.5	175	A30	TA25DU11	7.5 - 11
5.5	11.5	XT2S160 MF 12.5	175	A30	TA25DU14	10 - 14
7.5	15.5	XT2S160 MA 20	210	A30	TA25DU19	13 - 19
11	22	XT2S160 MA 32	288	A30	TA42DU25	18 - 25
15	29	XT2S160 MA 52	392	A50	TA75DU42	29 - 42
18.5	35	XT2S160 MA 52	469	A50	TA75DU42	29 - 42
22	41	XT2S160 MA 52	547	A50	TA75DU52	36 - 52
30	55	XT2S160 MA 80	840	A63	TA75DU63	45 - 63
37	66	XT2S160 MA 80	960	A75	TA75DU80	60 - 80
45	80	XT2S160 MA 100	1200	A95	TA110DU110	80 - 110
55	97	XT3S250 MA 160	1440	A110	TA110DU110	80 - 110
75	132	XT3S250 MA 200	1800	A145	TA200DU175	130 - 175
90	160	XT3S250 MA 200	2400	A185	TA200DU200	150 - 200
110	193	T5S400 PR221-I In320	2720	AF205	EF205-210	63 - 210
132	230	T5S400 PR221-I In400	3200	AF265	EF370-380	115 - 380
160	280	T5S400 PR221-I In400	4000	AF305	EF370-380	115 - 380
200	350	T5S630 PR221-I In630	5040	AF370	EF370-380	115 - 380
250	430	T6S630 PR221-I In630	6300	AF460	EF460-500	150 - 500
290	520	T6S800 PR221-I In800	8000	AF580	EF750-800	250 - 800
315	540	T6S800 PR221-I In800	8000	AF580	EF750-800	250 - 800
355	610	T6S800 PR221-I In800	8000	AF750	EF750-800	250 - 800

# Type 2 co-ordination

## MCCB SD-NS

SCPD type: MCCB

Rated voltage: 400/415 V

Short circuit current: 50 kA

Starting type: SD-NS

Coordination type: IEC Type 2 / IE1 /IE2

Overload relay: TOL

Frequency: 50-60 Hz

Motor		MCCB		Contactor			Thermal release	
Pe [kW]	Ie [A]	Type	Im [A]	Line type	Delta type	Star type	Type	[A]
18.5	35	XT2S160 MA52	469	A50	A50	A26	TA75DU25	18-25
22	41	XT2S160 MA52	547	A50	A50	A26	TA75DU32	22-32
30	55	XT2S160 MA80	720	A63	A63	A30	TA75DU42	29-42
37	66	XT2S160 MA80	840	A75	A75	A30	TA75DU52	36-52
45	80	XT2S160 MA100	1050	A75	A75	A30	TA75DU63	45-63
55	97	XT2S160 MA100	1200	A75	A75	A40	TA75DU63	45-63
75	132	XT3S250 MA160	1700	A95	A95	A75	TA110DU90	66-90
90	160	XT3S250 MA200	2000	A110	A110	A95	TA110DU110	80-110
110	195	XT3S250 MA200	2400	A145	A145	A95	TA200DU135	100-135
132	232	T5S400 PR221-I In320	2880	A145	A145	A110	EF205-210	60-200
160	282	T5S400 PR221-I In400	3600	A185	A185	A145	EF205-210	60-200
200	350	T5S630 PR221-I In630	5040	AF265	AF265	AF190	EF370-380	115-380
250	430	T6S630 PR221-I In630	6300	AF265	AF265	AF190	EF370-380	115-380
290	520	T6S630 PR221-I In630	8000	AF580	AF580	AF400	EF750-800	250-800
315	540	T6S800 PR221-I In800	8000	AF580	AF580	AF400	EF750-800	250-800
355	610	T6S800 PR221-I In800	8000	AF580	AF580	AF400	EF750-800	250-800

# Spares for contactors

## Spare coils for A range

For contactor types	Type code reference	Ordering code	L.P.(₹)
N, A9.....A16, UA16..RA	ZA16 **	1SBN151410R□□06	Upon request
A26..A40;UA26..UA30 RA	ZA40 **	1SBN152410R□□06	
A45..A75;UA50..UA75 RA	ZA75 **	1SBN153510R□□06	
A95..A110; UA95..UA110 RA	ZA110 **	1SFN154310R□□06	
A145...A185	ZA185 **	1SFN154710R□□06	
A210...A300	ZA300 **	1SFN155110R□□06	

## Spare coils for AF range

For contactor types	Type code reference	Ordering code	L.P.(₹)
AF45...AF75	ZAF75	1SBN153570R□□06	Upon request
AF95...AF110	ZAF110	1SFN153370R□□06	
AF145...AF185	ZAF185	1SFN154770R□□06	
AF210,AF260 &AF300	ZAF300	1SFN155170R□□06	
AF400...AF460	ZAF460**	1SFN155770R□□06	
AF580...AF750**	ZAF750**	1SFN156170R□□06	

## Coil voltages & codes

N range, A09.....A300, UA....RA, AX09...AX205			AF45...AF300			AF400...AF750		
Voltage V-50 Hz	Voltage V-60 Hz	Code	Voltage V-50/60 Hz	Voltage V..dc	Code	Voltage V-50/60 Hz	Voltage V..dc	Code
24	24	81		20....60	72*		24....60	68
110	110....120	84	48....130	48....130	69	48....130	48....130	69
220....230	230....240	80	100....250	100....250	70	100....250	100....250	70
400....415	415....440	86				250....500	250....500	71

\* For contactor AF95...AF300

## Spare contact sets for 3 pole

Description	For contactor types	Type code reference	Ordering code	L.P.(₹)
Contact set for 3 -pole contactors consisting of 6 fixed contacts, 3 moving contacts, springs and the required screws.	A/AF/AE/TAE50	ZL 50	1SBN163503R1000 ■	Upon request
	A/AF/AE/TAE63	ZL 63	1SBN163703R1000 ■	
	A/AF/AE/TAE75	ZL 75	1SBN164103R1000 ■	
	A/AF/AE/TAE95	ZL 95	1SFN164303R1000 ■	
	A/AF/AE/TAE110	ZL 110	1SFN164503R1000 ■	
	A/AF145	ZL 145	1SFN164703R1000 ■	
	A/AF185	ZL 185	1SFN164903R1000 ■	
	A/AF210	ZL 210	1SFN165103R1000 ■	
	A/AF260	ZL 260	1SFN165303R1000 ■	
	A/AF300	ZL 300	1SFN165503R1000 ■	
	AF400	ZL 400	1SFN165703R1000 ■	
	AF460	ZL 460	1SFN165903R1000 ■	
	AF 580	ZL 580	1SFN166103R1000 ■	
	AF 750	ZL 750	1SFN166303R1000 ■	
	UA 50	ZLU 50	1SBN163502R1000	
	UA 63	ZLU 63	1SBN163702R1000	
UA 75	ZLU 75	1SBN164102R1000		

## Spare contact sets for 3 pole for AX

For contactor types	Type code reference	Ordering code	L.P.(₹)
AX50	ZLX50	1SBN163506R1000	Upon request
AX65	ZLX65	1SBN163706R1000	
AX80	ZLX80	1SBN164106R1000	
AX95	ZLX95	1SFN164306R1000	
AX115	ZLX115	1SFN169806R1000	
AX150	ZLX150	1SFN169906R1000	
AX185	ZLX185	1SFN164906R1000	
AX205	ZLX205	1SFN165006R1000	

## Spare coils for AX range

For contactor types	Type code reference	Ordering code	L.P.(₹)
AX25	ZAX25	1SBN158910R□□36	Upon request
AX40	ZAX40	1SBN152810R□□36	
AX80	ZAX80	1SBN153510R□□36	
AX150	ZAX150	1SFN159910R□□36	
AX205	ZAX205	1SFN155010R□□36	

Complete the contactor type code by replacing□□ with desired coil voltage from above mentioned table

\* Consider Spare price list for other products.

■ Stock items

# Introduction

## ABB Service

### ABB Service is more than a simple Service!

ABB is a pioneering technology leader for utilities, industries, transportations and infrastructures.

The company was found in 1988 by the merger between ASEA and Brown Bover & Cie (BBC), two of the most important electrical companies of the last century.

ABB has extensively invested in Service developing advanced solutions aim to guarantee the continuous revamping of products and systems according to the technology progress.

### Spare Parts

Spare Parts availability is the key of a successful Service!

A spare part is a replaceable product's component fundamental to ensure the functioning of the system to which it belongs.

Having original spare parts always at your disposal means guarantee of the highest level of performance to your plant, reducing significantly the risk of failure as well as the down-time due to the maintenance.

ABB guarantees 100 % of compatibility of all Spare Parts that are going to replace the defective components of your equipment.

All Spare Parts are equipped with instruction sheets to enable a correct and safety assembly and are delivered in short times in order to fulfill customer's needs.

## Service portfolio

### Life Cycle Management

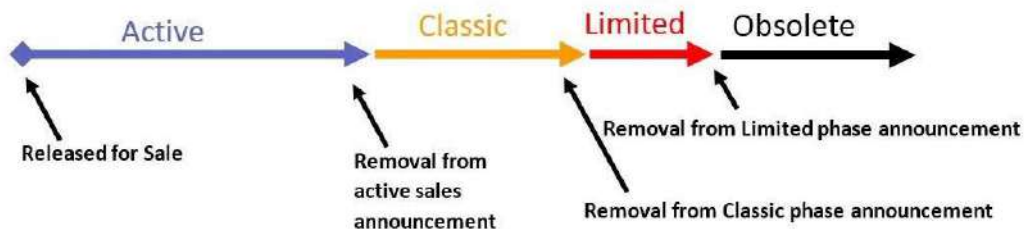

**Active** standard development, production and sale.

**Classic** maintenance phase of the product: spare parts availability is guaranteed for replacing in existing plants.

**Limited** spare parts are available. The production of the CB's whole range is not guaranteed, and the technical support is limited.

**Obsolete** technical support is no more guaranteed. The production of the CB's whole range has ended but spare parts might be available. Retrofit solutions are available.



# Service portfolio

Low voltage products division delivers a vast range of services to cover the whole product lifecycle. The services offered by ABB's low voltage products and systems span the entire value chain, from the moment a customer makes the first enquiry to disposal and recycling of the product. Throughout the value chain, ABB provides training, technical support and customized contracts. All of this is supported by one of the most extensive country sales and service network.

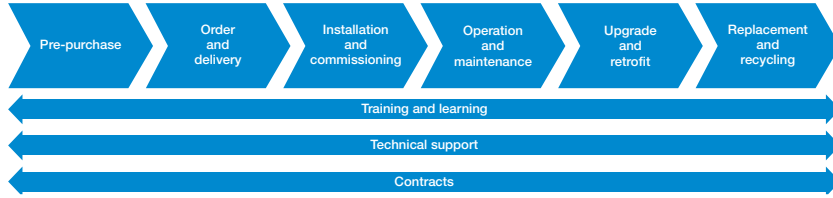

## Installation and commissioning

ABB provides comprehensive installation and commissioning services to achieve a problem-free start up, by following installation and commissioning procedures. The use of service personnel from ABB LP service ensures that the switchgear is installed in a safe and correct way.

## Operation and maintenance

ABB can guide the customer through a fast and efficient fault finding procedure as well as analyze the operation of the product and the customer's process. From site surveys to preventive, predictive maintenance and reconditioning, ABB has all the options covered to keep its customers' processes operational.

## Upgrade and retrofits Upgrades

An existing ABB product can often be upgraded to the latest software or hardware to improve the performance of the application. Existing processes can be economically modernized by upgrading with the latest technology.

## Retrofits

Replacing old LV Switchgear of any make with ABB's latest versions can be done using the ABB special conversion kits which enable quick installation without structural modifications to the original compartment. In addition complete "turnkey" solutions are available. Specific conversion kits have been developed in order to replace old components with new ones that can be found in the latest switchgears.

## Replacement and Recycling

ABB can advise on the best replacement products while ensuring that the existing products are disposed of in a way that meets all local regulations.

## Entire value chain services

The main services available throughout the entire value chain include:

### Training and learning – Hands on

ABB LP service carries out training programs. Those trainings can be either general or bespoke and have the aim of providing the personnel in charge of management/maintenance with the necessary know-how to achieve an excellent level of operating ability in certain situations. The manager of an electrical site can find it convenient to have certain maintenance capabilities available within his own team.

The courses mainly cover:

- Operating equipment
- Maintenance principles
- Repairs for small faults

### Technical support

At each stage of the value chain, an ABB expert is available to offer advice to keep the customer's process or plant operational.

### Spare parts

Availability of original spare parts is essential for fast and efficient maintenance activities. This becomes even more critical when the product was produced some years ago and has components in it which are no longer in production. ABB LP service is the only one able to supply original and guaranteed spare parts. These can be easily selected and ordered through the authorized channel.

### Maintenance contracts

In addition to the corrective maintenance of a faulty unit, which includes any type of emergency intervention, there is a complete preventive maintenance service package, ensuring those who manage the plant gain considerable advantages in terms of reliability, safety and reduction of costs. Also customized contracts can be devised between the customer and ABB. Depending on the severity of the intervention needed, it can often be done on-site by our skilled and experienced engineers and is a faster way of resolution. ABB LP service has an effective service network across the country and dedicated service workshops. For all your service requirements, contact our nearest Sales office.

### Benefits of maintenance contracts

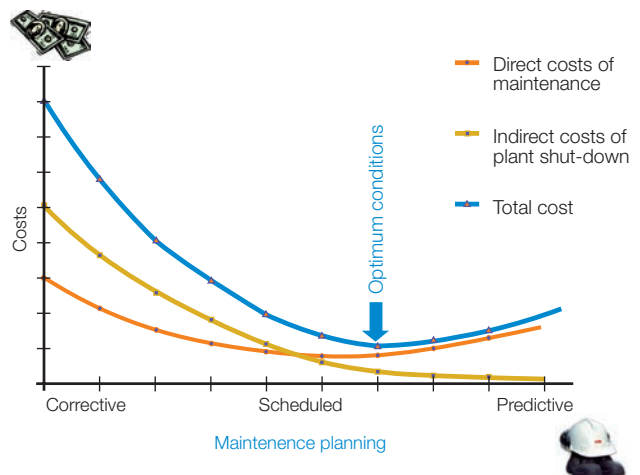

# Materials

## Technical material - SOC

### Selected optimized coordination (SOC) tables

ABB provides coordination tables for the selection of low voltage equipment, specifically tested for starting and protecting IE3 motors in the SOC tool.

Essential, enhanced and advanced solutions as introduced in this brochure can be selected there. Product selection for different types of starting methods are available as well, including direct-on-line, star-delta and softstarters. Usage of coordination tables helps reduce the time for selection and design of solutions as well as the risk of unwanted downtime, e.g. caused by nuisance tripping. This provides protection and safety, further driving down the total cost of ownership

more than **1800**  
tested and validated  
coordination tables  
available

You can find SOC tables [here](#)

### SOC - SELECTED OPTIMIZED COORDINATION

#### Coordination tables for Motor protection

→ Info on IE3 Motors

→ UL Motor Coordinations BETA

Clear selection

Standard:  IEC  UL

Motor efficiency class:  ANY  IE1/IE2/IE3 N/H  IE3 NE/HE

Motor Rated Power [kW]	Rated voltage	Short-Circuit Current [kA]	Starter Type	Coordination type	Protection device	Overload relay
0.06	208Vac	3	DOL-NS	IEC Type 1	ACB	Embedded
0.09	230Vac	5	DOL-HD	IEC Type 2	Fuses	TOL
0.12	240Vac	12	SD-NS		MCCB	EOL
0.18	400Vac	16	SD-HD		MMS	UMC
0.26	415Vac	20	SS-NS-IL			
0.37	440Vac	22	SS-NS-ID			
0.55	480Vac	25				
0.75	480Vac	27				
1.1	500Vac	30				
1.5	525Vac	35				

Search Export PDF

Results 1398 Internal use only records.

20 Number of Records to show

ACB, 415 Vac, 42 kA, DOL-NS, Coordination type : IEC Type 2, Overload relay : Embedded, Motor efficiency class IE1/IE2/IE3 N/H

Motor	SACE Emax Circuit Breaker	Inst.Trip.Current [A]	Max allowed load current [A]	Status	Table
Motor Rated Power [kW]	Rated Current (FLA) [A]	Type			

### IE3/IE4 Motor **NEW**

SOC - Selected Optimized Coordination

Motor protection | Selectivity | Back-up | Other Devices protection

Standard:  IEC  UL

Starting type:  Normal start  Heavy duty

Motor Efficiency Class - Design:  Any  IE1/IE2/IE3/IE4 - N/H  IE3/IE4 - NE/HE

Table status:  Any  Active  Legacy

Starter Type	Rated voltage	Motor Rated Power	Short-Circuit Current	Coordination type	Protection device	Overload protection
Direct-on-line starter	230 V AC	0,06 kW	25 kA	IEC Type 1	Switch fuse	Embedded
Star-Delta starter	400 V AC	0,09 kW	35 kA	IEC Type 2	Molded case circuit-breaker	Thermal overload relay
	415 V AC	0,12 kW	36 kA		Manual motor starter	Electronic overload relay
	440 V AC	0,18 kW	42 kA			Universal motor controller
	500 V AC	0,25 kW	50 kA			
	525 V AC	0,37 kW	65 kA			
	690 V AC	0,55 kW	70 kA			

131 Coordination tables found

Export PDF PDF Books Reset filters

# Materials

## Technical material - e-Configure

e-Configure is a product and application configuration tool for low voltage products and solutions that provides customers a quick and easy configuration process.

- Browse for products by categories, product code or description
- Retrieve product related information (specs, prices, availability)
- Select and configure products and accessories
- Create, modify and order the bill of material
- Re-order custom configured units

You can find e-Configure [here](#)

The screenshot shows the top navigation bar with 'e-Configure', 'Categories', and 'Solutions' tabs. A search bar and a cart icon are on the right. The main content area features a 'Welcome to e-Configure' heading, a 'First time here?' sub-heading, and a video player. The video player has a play button and a title: 'ABB e-Configure that make configuring and ordering solutions simpler and quicker.' The video thumbnail shows a central play button icon surrounded by icons representing various industrial applications: a factory, a server rack, a person, a mobile phone, a car, and a building.

The screenshot shows the 'Categories' page. On the left is a vertical sidebar with a list of categories: Circuit Breakers, Installation Products, Enclosed Switches, Switches, Fusegear, Low Voltage Switchgear & MCC, Cable Distribution Cabinets, Enclosures, Modular DIN Rail Products, Motor protection and control, Softstarters, and Electronic relays and controls. The main content area displays a grid of product images with labels: 'Circuit Breakers', 'Installation Products', 'Enclosed Switches', 'Switches', 'Low Voltage Switchgear & MCC', and another 'Low Voltage Switchgear & MCC' category. The top navigation bar and search bar are also visible.

# Materials

## Technical material - 3D Portal

Cadenas provides 3D and 2D data for ABB Motor Starting & Safety products.

- Download CAD models in different file formats
- Generate Pdf data sheets

You can find 3D Portal [here](#)

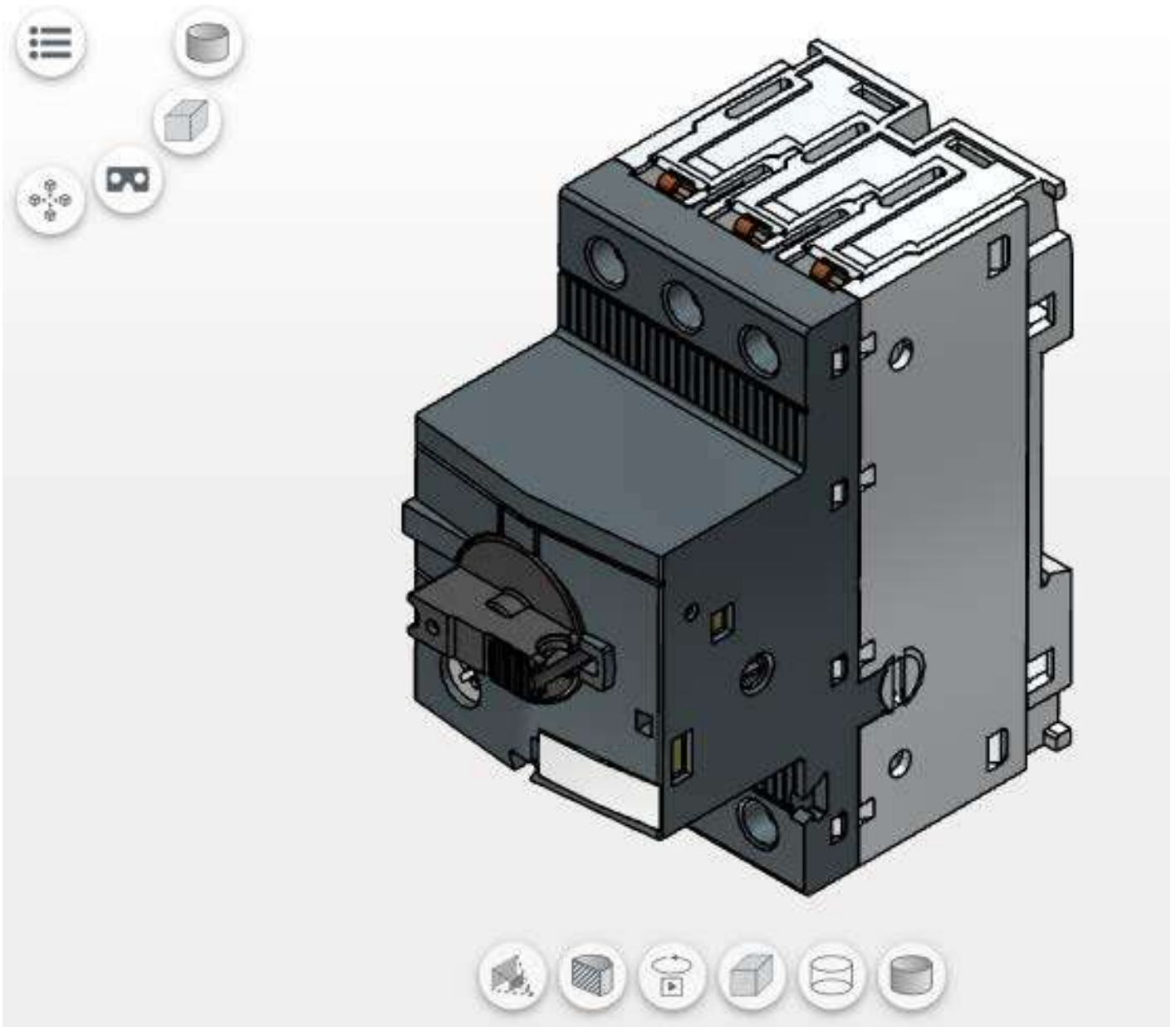

---

## **Electrification India has launched eMart, a B2B & B2C online marketplace** in August 2020 for bringing ABB products and solutions closer and nearer to our customers than ever.

Customers will have easy access to more than 6,000 ABB home and industrial products and solutions in one of the fastest growing e-commerce markets in the world.

This unique B2B & B2C platform is the first of its kind in the industry, owing to its dynamic, price transparent model. It aims to provide an equally fair and favorable experience to both ABB distributors and customers. ABB eMart also provides a dynamic model to empower our partners to set their own competitive pricing for the products they sell on the platform, while simultaneously providing customers with a choice of the best deals to suit their specific needs.

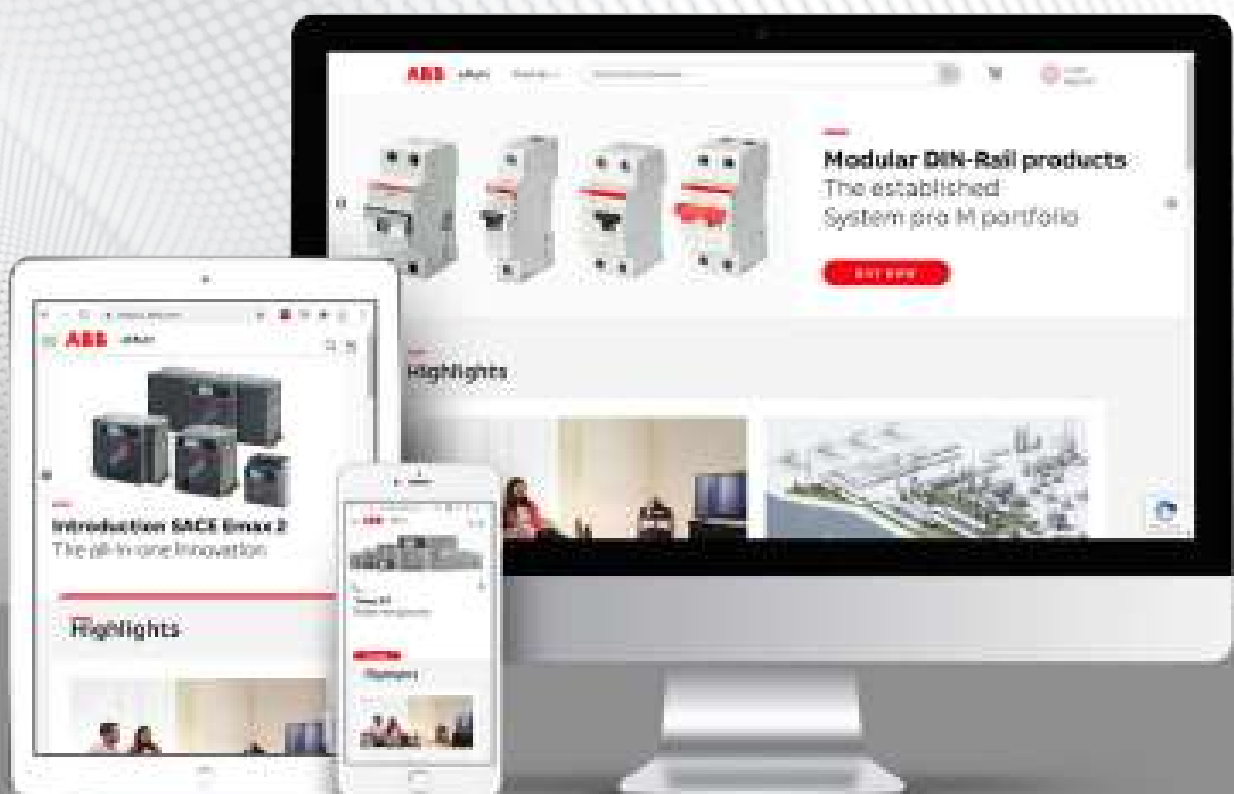

Click below to find offerings from eMart.



MCCB



Isolator



MCB



Meter



RCD



Switches, Sockets & Accessories



Fusegear



Transfer Switch



Switch Disconnecter



Industrial Plug & Socket



Contactor



Interface Products



Manual Motor Starters



Measuring and Monitoring Relays



Pilot Device



Power Supply



Safety Products



Time Relays



Universal Motor Controller



Overload Relays

# General conditions of sale

## General terms and conditions of sale:

- All prices mentioned in this price list are in Indian Rupees (INR) and this supersedes all previous price lists
- Prices are based on Ex-work basis
- Maximum retail prices (MRPs) mentioned in the publication are maximum recommended selling prices
- List prices (LPs) mentioned are exclusive of all taxes
- Prices are subject to revision without prior notice

Terms of delivery: Ex- work, Nelamangala or any other ABB warehouse in India

## Standard delivery terms

Ex-stock or up to 45 working days

## Address of Nelamangala warehouse

### ABB INDIA LIMITED

#126, Hanchipura Village, Kasaba Hobli  
Nelamangala Taluk, Bangalore-562 123

Tel: +91 80 2770 0081

Tel: +91 80 2770 0082

Tel: +91 80 2770 0083

## Address of Works

### Nelamangala

Survey No: 88/3, 88/4, Basavanhalli, Kasaba Hobli,  
Nelamangala Taluk, Bangalore - 562 123

Karnataka, India

Tel: +91 80 2294 6618

Tel: +91 80 2294 6619

Fax: +91 80 2294 9999

### Peenya

Plot No. 5 & 6, II Phase,  
Peenya Industrial Area, Bangalore - 560 058

Karnataka, India

Tel: +91 80 22949354/9585

Fax: +91 80 22949389

### Vadodara

Maneja Works, Maneja,  
Vadodara - 390 013

Gujarat, India

E-mail: in-da.sales@abb.com

Tollfree No: 1800-4200-707

## Warranty policy

ABB guarantees the supply according to the law. Upon expiration, the warranty expires even if the devices have not been operated for any reason. In the case of faults, as long as this does not depend on assembly errors by the customer or third parties, on incorrect use of the materials, lack of or incorrect maintenance, normal wear and tear, faults caused by inexperience or negligence by the purchaser or by transport, by the improper storage of the materials, or failure by the customer to adopt measures to reduce eventual dysfunction, overload with respect to the contractual limits, by unauthorized intervention, by tampering or action effected by the customer, to force majeure, ABB will, throughout the warranty period, repair or replace any defective part of supply free of charge, in the shortest possible time, at its premises. Where the repair cannot be executed at ABB premises, except as otherwise agreed, all the supplementary or relevant expenses shall be borne by the customer.

Repair or replacement will be executed only if the customer has performed all the obligations to that date. The customer may not suspend performance of the obligations in any case in which this warranty is invoked. The term for the repair or replacement of the faulty supply will be agreed by ABB and the customer. The shipment of any supply claimed to be faulty by the customer to ABB and subsequently by ABB to the customer, shall be at the risk and under the responsibility of the customer, who shall arrange adequate insurance coverage. The supply repaired or replaced is shipped at the expense and risk of the customer. Any dispute about a shipment has no effect on the remainder of the supply. The products replaced by ABB become the property of ABB.



# General conditions of sale

Any claim regarding the supply, machinery, plant or components not compliant with the specifications or the contractual documentation must be raised in writing, within a maximum term of 8 days from delivery, when the time limit for action expires. In the case of systems, this term is 60 days from execution of the disputed service when the time limit for action expires.

In the case of latent defects, the terms indicated above run from the date of discovery. Once the warranty period has expired, claims are not accepted, even for latent defect. Where the claim is timely and justified, ABB's obligation is limited to replacement of the goods found not in compliance or repetition of execution of the non-compliant service, excluding all rights to the Customer to seek termination of the contract and/or compensation of damages.

With reference to the provision of spare parts, ABB reserves the right to provide materials either from the original supplier or from equivalent supplier.

## Warranty period:

1. **Breakers & switches:** The warranty period is 12 months from the date of commissioning or 18 months from the date of ABB's invoice, whichever is earlier.
2. **Control products:** The warranty period is 12 months from the date of commissioning or 18 months from the date of ABB's invoice, whichever is earlier.
3. **Enclosures & Din Rail components:**
  - Components of SB200M and SDB200 will have 5 Years warranty from the date of ABB's invoice, if mounted inside the ABB Distribution boards. If non- ABB enclosure is used, Warranty period is 12 months from the date of commissioning or 18 months from the date of ABB's invoice, whichever is earlier.
  - All other range of products : 12 months from the date of commissioning or 18 months from the date of ABB's invoice, whichever earlier.

- If products are altered, dismantled, rectified or tampered. Warranty states is not company's entire liability. This does not extend to cover consequential losses or damage or installation cost arising from defective products. Since product improvement is a continuous process, the data furnished in this brochure may undergo revision. For the latest information, you may contact our nearest sales office.

## 4a. Wiring accessories:

- Standard Switches & Sockets (without LED Lamp) : 10 years from the date of ABB's invoice.
- Electronic Products (with LED Lamp) : 12 months from the date of commissioning or 24 months from the date of ABB's invoice, whichever earlier.
- ABB mounting boxes are not covered under warranty.
- If products are altered, dismantled, rectified or tampered. Warranty states is not company's entire liability. This does not extend to cover consequential losses or damage or installation cost arising from defective products. Since product improvement is a continuous process, the data furnished in this brochure may undergo revision. For the latest information, you may contact our nearest sales office.

- 4b. **Plug & sockets:** The warranty period is 12 months from the date of commissioning or 18 months from the date of ABB's invoice, whichever is earlier.

## Liability clause:

The manufacturer shall not be liable for any consequential loss, injury or damages attributable to defect or failure of its products.







---

**ABB India Helpline.**

Technical telephone support for customers and channel partners.

Toll free: (BSNL) +91 1800 420 07 07

[new.abb.com/low-voltage](https://new.abb.com/low-voltage)

