

PROJECT PRICE LIST

2023

EFFECTIVE APRIL 2023



Contents

—optipro—	MINIATURE CIRCUIT BREAKER (MCBs)	01 - 04
—optipro—	AC CIRCUIT BREAKER	05
—optipro—	DC CIRCUIT BREAKER	05 - 06
—optipro—	DC MCB WITH EXTENDED LINK AS PER RDSO	06
—optipro—	ISOLATOR	07
—optipro—	RESIDUAL CURRENT CIRCUIT BREAKER (RCCBs)	07
—optipro—	RCD ADD ON BLOCK	08
—optipro—	ACCESSORIES	08
—optipro—	DISTRIBUTION BOARDS (DBs)	09 - 15
	BUSBAR CHAMBER	16
	TIME SWITCHES	17
	TIMELITE DISTRIBUTION BOARDS	18
	AUTOMATIC CHANGEOVER	18
—optium—	MCCB - 1.0 (FIXED TM RANGE)	19 - 21
—optium—	MCCB - 2.0 (ADJUSTABLE TM RANGE)	21 - 23
—optium—	MCCB - 2.1 (ELECTRONIC RANGE)	23
—optium—	MCCB - 2.2 (ELECTRONIC RANGE WITH GROUND FAULT SETTING)	23 - 24
—optium—	MCCB - ACCESSORIES	24 - 26
—optipro—	SMDB	27 - 30
NEW —optinova—	SWITCH DISCONNECTOR / TSE (ONLOAD CHANGEOVER)	31 - 34
	HRC FUSE LINKS & BASES	35
	SWITCH DISCONNECTOR FUSES	36
	Ambidex CHANGEOVER SWITCHES	37
	REWIRABLE SWITCH FUSE UNITS	38
	Shynora WIRING ACCESSORIES	39 - 49
	Glint [™] WIRING ACCESSORIES	50 - 56
	ELVIRA WIRING ACCESSORIES	57 - 62
	[™] EXHAUST FAN	63 - 64
	INDOASIAN PLUGS	64
	FANCY BATTEN BULB HOLDER / CEILING ROSE	64 - 65

—optipro— **MINIATURE CIRCUIT BREAKER - MCB**

- ISI / CE Marked as per IS/IEC 60898 - 1 • Rated Short-Circuit Breaking Capacity, Icn 10kA • Degree of Protection IP 20
- Energy Limitation Class 3 • Line Load Reversibility • 35 sq. mm Terminals • Biconnect Terminals • Frequency: 50 Hz
- Operating Voltage : 240V/415V AC , 60V DC per pole

B CURVE SINGLE POLE

HSN Code: 8536

	Rating (A)	Pack	Cat. Nos.	Unit Price (₹)
	6	1/12/180	811008	258
	10	1/12/180	811010	258
	16	1/12/180	811012	258
	20	1/12/180	811013	258
	25	1/12/180	811014	258
	32	1/12/180	811015	258
	40	1/12/180	811016	580
	50	1/12/180	811017	676
	63	1/12/180	811018	676

B CURVE SINGLE POLE NEUTRAL

HSN Code: 8536

	Rating (A)	Pack	Cat. Nos.	Unit Price (₹)
	6	1/6/90	811027	866
	10	1/6/90	811029	866
	16	1/6/90	811031	866
	20	1/6/90	811032	866
	25	1/6/90	811033	866
	32	1/6/90	811034	866
	40	1/6/90	811035	1212
	50	1/6/90	811036	1374
	63	1/6/90	811037	1374

B CURVE DOUBLE POLE

HSN Code: 8536

	Rating (A)	Pack	Cat. Nos.	Unit Price (₹)
	6	1/6/90	811046	900
	10	1/6/90	811048	900
	16	1/6/90	811050	900
	20	1/6/90	811051	900
	25	1/6/90	811052	900
	32	1/6/90	811053	900
	40	1/6/90	811054	1296
	50	1/6/90	811055	1444
	63	1/6/90	811056	1444

C CURVE SINGLE POLE

HSN Code: 8536

	Rating (A)	Pack	Cat. Nos.	Unit Price (₹)
	0.5	1/12/180	811114	454
	1	1/12/180	811115	454
	2	1/12/180	811117	454
	3	1/12/180	811119	454
	4	1/12/180	811120	454
	5	1/12/180	811121	454
	6	1/12/180	811122	270
	10	1/12/180	811124	270
	16	1/12/180	811126	270
	20	1/12/180	811127	270
	25	1/12/180	811128	270
	32	1/12/180	811129	270
	40	1/12/180	811130	546
	50	1/12/180	811131	650
63	1/12/180	811132	650	

—optipro— **MINIATURE CIRCUIT BREAKER - MCB**

C CURVE SINGLE POLE NEUTRAL

HSN Code: 8536

	Rating (A)	Pack	Cat. Nos.	Unit Price (₹)
	0.5	1/6/90	811136	950
1	1/6/90	811137	950	
2	1/6/90	811139	950	
3	1/6/90	811141	950	
4	1/6/90	811142	950	
5	1/6/90	811143	950	
6	1/6/90	811144	892	
10	1/6/90	811146	892	
16	1/6/90	811148	892	
20	1/6/90	811149	892	
25	1/6/90	811150	892	
32	1/6/90	811151	892	
40	1/6/90	811152	1260	
50	1/6/90	811153	1420	
63	1/6/90	811154	1420	

C CURVE DOUBLE POLE

HSN Code: 8536

	Rating (A)	Pack	Cat. Nos.	Unit Price (₹)
	0.5	1/6/90	811158	1088
1	1/6/90	811159	1088	
2	1/6/90	811161	1088	
3	1/6/90	811163	1088	
4	1/6/90	811164	1088	
5	1/6/90	811165	1088	
6	1/6/90	811166	916	
10	1/6/90	811168	916	
16	1/6/90	811170	916	
20	1/6/90	811171	916	
25	1/6/90	811172	916	
32	1/6/90	811173	916	
40	1/6/90	811174	1330	
50	1/6/90	811175	1492	
63	1/6/90	811176	1492	

6

C CURVE THREE POLE

HSN Code: 8536

	Rating (A)	Pack	Cat. Nos.	Unit Price (₹)
	0.5	1/4/60	811180	1670
1	1/4/60	811181	1670	
2	1/4/60	811183	1670	
3	1/4/60	811185	1670	
4	1/4/60	811186	1670	
5	1/4/60	811187	1670	
6	1/4/60	811188	1432	
10	1/4/60	811190	1432	
16	1/4/60	811192	1432	
20	1/4/60	811193	1432	
25	1/4/60	811194	1432	
32	1/4/60	811195	1432	
40	1/4/60	811196	2076	
50	1/4/60	811197	2194	
63	1/4/60	811198	2194	

—optipro— **MINIATURE CIRCUIT BREAKER - MCB**

C CURVE THREE POLE NEUTRAL

HSN Code: 8536

	Rating (A)	Pack	Cat. Nos.	Unit Price (₹)
	0.5	1/3/45	811202	2144
1	1/3/45	811203	2144	
2	1/3/45	811205	2144	
3	1/3/45	811207	2144	
4	1/3/45	811208	2144	
5	1/3/45	811209	2144	
6	1/3/45	811210	1844	
10	1/3/45	811212	1844	
16	1/3/45	811214	1844	
20	1/3/45	811215	1844	
25	1/3/45	811216	1844	
32	1/3/45	811217	1844	
40	1/3/45	811218	2456	
50	1/3/45	811219	2600	
63	1/3/45	811220	2600	

C CURVE FOUR POLE

HSN Code: 8536

	Rating (A)	Pack	Cat. Nos.	Unit Price (₹)
	0.5	1/3/45	811224	2176
1	1/3/45	811225	2176	
2	1/3/45	811227	2176	
3	1/3/45	811229	2176	
4	1/3/45	811230	2176	
5	1/3/45	811231	2176	
6	1/3/45	811232	2042	
10	1/3/45	811234	2042	
16	1/3/45	811236	2042	
20	1/3/45	811237	2042	
25	1/3/45	811238	2042	
32	1/3/45	811239	2042	
40	1/3/45	811240	2772	
50	1/3/45	811241	2834	
63	1/3/45	811242	2834	

D CURVE SINGLE POLE

HSN Code: 8536

	Rating (A)	Pack	Cat. Nos.	Unit Price (₹)
	0.5	1/12/180	811246	464
1	1/12/180	811247	464	
2	1/12/180	811249	464	
3	1/12/180	811251	464	
4	1/12/180	811252	464	
5	1/12/180	811253	464	
6	1/12/180	811254	396	
10	1/12/180	811256	396	
16	1/12/180	811258	396	
20	1/12/180	811259	396	
25	1/12/180	811260	396	
32	1/12/180	811261	396	
40	1/12/180	811262	654	
50	1/12/180	811263	746	
63	1/12/180	811264	746	

—optipro— **MINIATURE CIRCUIT BREAKER - MCB**

D CURVE DOUBLE POLE

HSN Code: 8536

	Rating (A)	Pack	Cat. Nos.	Unit Price (₹)
	0.5	1/6/90	811284	1228
1	1/6/90	811285	1228	
2	1/6/90	811287	1228	
3	1/6/90	811289	1228	
4	1/6/90	811290	1228	
5	1/6/90	811291	1228	
6	1/6/90	811292	956	
10	1/6/90	811294	956	
16	1/6/90	811296	956	
20	1/6/90	811297	956	
25	1/6/90	811298	956	
32	1/6/90	811299	956	
40	1/6/90	811300	1370	
50	1/6/90	811301	1458	
63	1/6/90	811302	1458	

D CURVE THREE POLE

HSN Code: 8536

	Rating (A)	Pack	Cat. Nos.	Unit Price (₹)
	0.5	1/4/60	811303	1818
1	1/4/60	811304	1818	
2	1/4/60	811306	1818	
3	1/4/60	811308	1818	
4	1/4/60	811309	1818	
5	1/4/60	811310	1818	
6	1/4/60	811311	1454	
10	1/4/60	811313	1454	
16	1/4/60	811315	1454	
20	1/4/60	811316	1454	
25	1/4/60	811317	1454	
32	1/4/60	811318	1454	
40	1/4/60	811319	2194	
50	1/4/60	811320	2222	
63	1/4/60	811321	2222	

D CURVE FOUR POLE

HSN Code: 8536

	Rating (A)	Pack	Cat. Nos.	Unit Price (₹)
	0.5	1/3/45	811341	2204
1	1/3/45	811342	2204	
2	1/3/45	811344	2204	
3	1/3/45	811346	2204	
4	1/3/45	811347	2204	
5	1/3/45	811348	2204	
6	1/3/45	811349	1900	
10	1/3/45	811351	1900	
16	1/3/45	811353	1900	
25	1/3/45	811355	1900	
32	1/3/45	811356	1900	
40	1/3/45	811357	2714	
50	1/3/45	811358	2812	
63	1/3/45	811359	2812	

—optipro— **AC CIRCUIT BREAKER**

- Conforms to IEC 60947-2 • CE Marked • Rated Short-Circuit Capacity, Icu 10kA • Degree of Protection IP 20
- 1.5 Module per pole • 50 sq. mm Terminals • Frequency: 50 Hz • Operating Voltage: 240V/415V AC, 60V DC per Pole

SINGLE POLE

HSN Code: 8536

	Rating (A)	Pack	Cat. Nos.	Unit Price (₹)
	80	1	811133	2352
	100	1	811134	2606
	125	1	811135	2904

DOUBLE POLE

HSN Code: 8536

	Rating (A)	Pack	Cat. Nos.	Unit Price (₹)
	80	1	811177	5412
	100	1	811178	5822
	125	1	811179	6380

THREE POLE

HSN Code: 8536

	Rating (A)	Pack	Cat. Nos.	Unit Price (₹)
	80	1	811199	7966
	100	1	811200	8586
	125	1	811201	9328

FOUR POLE

HSN Code: 8536

	Rating (A)	Pack	Cat. Nos.	Unit Price (₹)
	80	1	811243	10412
	100	1	811244	10752
	125	1	811245	12224

—optipro— **DC CIRCUIT BREAKER**

- Conforms to IEC 60947-2 • CE Marked • Breaking Capacity 6kA • Degree of Protection IP 20 • 35 sq. mm Terminals
- Biconnect Terminals • Upto 250V Supply

SINGLE POLE

HSN Code: 8536

	Rating (A)	Pack	Cat. Nos.	Unit Price (₹)
	0.5	1/12/180	811400	608
	1	1/12/180	811401	608
	2	1/12/180	811403	608
	3	1/12/180	811405	608
	4	1/12/180	811406	608
	5	1/12/180	811407	608
	6	1/12/180	811408	546
	10	1/12/180	811410	546
	16	1/12/180	811412	546
	20	1/12/180	811413	546
	25	1/12/180	811414	546
	32	1/12/180	811415	546
	40	1/12/180	811416	724
	50	1/12/180	811417	748
	63	1/12/180	811418	748

—optipro— DC CIRCUIT BREAKER

DOUBLE POLE

HSN Code: 8536

	Rating (A)	Pack	Cat. Nos.	Unit Price (₹)
		0.5	1/6/90	811419
1		1/6/90	811420	1372
2		1/6/90	811422	1372
3		1/6/90	811424	1372
4		1/6/90	811425	1372
5		1/6/90	811426	1372
6		1/6/90	811427	1126
10		1/6/90	811429	1126
16		1/6/90	811431	1126
20		1/6/90	811432	1126
25		1/6/90	811433	1126
32		1/6/90	811434	1126
40		1/6/90	811435	1538
50		1/6/90	811436	1652
63		1/6/90	811437	1652

OPTIPRO DC MCB WITH EXTENDED LINK AS PER RDSO

HSN Code: 8536

	Rating (A)	Pack	Cat. Nos.	Unit Price (₹)
	0.5	1/-/48	811451	652
	1	1/-/48	811452	652
	1.5	1/-/48	811453	652
	1.6	1/-/48	811454	652
	2	1/-/48	811455	652
	2.5	1/-/48	811456	652
	3	1/-/48	811457	652
	4	1/-/48	811458	652
	5	1/-/48	811459	652
	6	1/-/48	811460	610
	7.5	1/-/48	811461	610
	10	1/-/48	811462	610
	15	1/-/48	811463	610
	16	1/-/48	811464	610
	20	1/-/48	811465	610
	25	1/-/48	811466	610
	30	1/-/48	811467	610
	35	1/-/48	811468	808
	40	1/-/48	811469	808
	50	1/-/48	811470	808
60	1/-/48	811471	808	

—optipro— **ISOLATOR**

- Conforms to IEC 60947-3 • CE Marked • Degree of Protection IP 20 • 35 sq. mm Terminals • Biconnect Terminals
- Frequency: 50 Hz • Operating Voltage: 240V/415V AC, 60V DC per Pole

DOUBLE POLE

HSN Code: 8536

	Rating (A)	Pack	Cat. Nos.	Unit Price (₹)
	40	1/6/90	811550	566
	63	1/6/90	811551	698
	80	1/6/90	811552	902
	100	1/6/90	811553	902
	125	1/6/90	811554	972

THREE POLE

HSN Code: 8536

	Rating (A)	Pack	Cat. Nos.	Unit Price (₹)
	40	1/4/60	811555	1058
	63	1/4/60	811556	1210
	80	1/4/60	811557	1364
	100	1/4/60	811558	1364
	125	1/4/60	811559	1496

FOUR POLE

HSN Code: 8536

	Rating (A)	Pack	Cat. Nos.	Unit Price (₹)
	40	1/3/45	811560	1264
	63	1/3/45	811561	1364
	80	1/3/45	811562	1694
	100	1/3/45	811563	1694
	125	1/3/45	811564	1832

—optipro— **RESIDUAL CURRENT CIRCUIT BREAKER - RCCB**

- ISI/CE marked as per IS/IEC 12640-1 • Degree of Protection IP 20 • Rated Conditional Short-Circuit Current, Icc10kA
- 35 sq. mm Terminals • Biconnect Terminals • Frequency: 50 Hz • Operating Voltage: 240V/415V AC

DOUBLE POLE

HSN Code: 8536

	Rating (A)	Sensitivity (mA)	Pack	Cat. Nos.	Unit Price (₹)
	25	30	1/6/90	811700	3170
		100	1/6/90	811706	3170
		300	1/6/90	811712	3300
	40	30	1/6/90	811701	3256
		100	1/6/90	811707	3256
		300	1/6/90	811713	3550
	63	30	1/6/90	811702	4354
		100	1/6/90	811708	4354
		300	1/6/90	811714	4448

FOUR POLE

HSN Code: 8536

	Rating (A)	Sensitivity (mA)	Pack	Cat. Nos.	Unit Price (₹)
	25	30	1/3/45	811718	4066
		100	1/3/45	811724	4066
		300	1/3/45	811730	4222
	40	30	1/3/45	811719	4170
		100	1/3/45	811725	4170
		300	1/3/45	811731	4402
	63	30	1/3/45	811720	4512
		100	1/3/45	811726	4512
		300	1/3/45	811732	4592

—optipro— **RCD ADD ON BLOCK**

- **Conforms to IEC 60947-2 • Degree of Protection IP 20**
- **Rated Conditional Short-Circuit Current, I_{cc} 10kA • 35 sq. mm Terminals • Dual Position DIN Clip**

DOUBLE POLE

HSN Code: 8536

	Rating (A)	Sensitivity (mA)	Pack	Cat. Nos.	Unit Price (₹)
	6A - 32A	30	100	1/ - /32	811666
300		100	1/ - /32	811668	3488
300		300	1/ - /32	811670	3754
40A & 63A	30	100	1/ - /32	811667	3754
	100	100	1/ - /32	811669	4124
	300	300	1/ - /32	811671	4500

FOUR POLE

HSN Code: 8536

	Rating (A)	Sensitivity (mA)	Pack	Cat. Nos.	Unit Price (₹)
	6A - 32A	30	100	1/ - /16	811672
100		100	1/ - /16	811674	3960
300		100	1/ - /16	811676	4130
40A & 63A	30	100	1/ - /16	811673	4248
	100	100	1/ - /16	811675	4620
	300	300	1/ - /16	811677	4982

—optipro— **ACCESSORIES**

HSN Code: 8538

- **Conforms to IEC 60947 - 5 - 1 • Retro Fit Type Clip On Accessory • CE Marked**
- **Upto Three Number of Accessory on a Modular Device • Common Accessories for Entire Range • Easy To Install**

	Item Description	Pack	Cat. Nos.	Unit Price (₹)
	Auxiliary Changeover Switch 1NC	1	811580	424
Fault Signalling Contact 1NC	1	811581	1004	
Shunt Trip 12V to 48V AC/DC	1	811582	1728	
Shunt Trip 110V to 415V AC	1	811583	1728	
Undervoltage 24V & 48V AC/DC	1	811584	1508	
Undervoltage 240V AC	1	811585	1508	

— optipro™ — **DISTRIBUTION BOARDS (DBs)**

SPN DB-SINGLE DOOR

HSN Code: 8537

- IP : 30 Protection
- Door Earthing
- Isolated Neutral Bar
- Mechanical Impact Strength IK 08
- Cement Spill Protector

	Ways	Modules	Cat Ref.	Unit Price (₹)
	4	4	811800	1386
	6	6	811801	1450
	8	8	811802	1698
	12	12	811803	1988
	16	16	811804	2484

SPN DB-DOUBLE DOOR

HSN Code: 8537

- IP : 43 Protection
- Door Earthing
- Isolated Neutral Bar
- Mechanical Impact Strength IK 09
- Cement Spill Protector

	Ways	Modules	Cat Ref.	Unit Price (₹)
	4	4	811805	2070
	6	6	811806	2236
	8	8	811807	2318
	10	10	811812	2650
	12	12	811808	2794
	14	14	811810	3064
	16	16	811809	3394
	18	18	811811	3726

SPN DB -DOUBLE DOOR

HSN Code: 8537

- IP : 54 Protection
- Door Earthing
- Isolated Neutral Bar
- Mechanical Impact Strength IK 09
- Cement Spill Protector

	Ways	Modules	Cat Ref.	Unit Price (₹)
	4	4	811824	3188
	6	6	811825	3892
	8	8	811826	4160
	12	12	811828	5382
	16	16	811829	6644

SPN DB-ACRYLIC DOOR

HSN Code: 8537

- IP : 43 Protection
- Door Earthing
- Isolated Neutral Bar
- Cement Spill Protector

	Ways	Modules	Cat Ref.	Unit Price (₹)
	4	4	811816	2174
	6	6	811817	2588
	8	8	811818	2732
	12	12	811819	3354
	16	16	811820	4140

— optipro™ — **DISTRIBUTION BOARDS (DBs)**

TPN DB-SINGLE DOOR

HSN Code: 8537

- IP : 30 Protection
- Door Earthing
- Isolated Neutral Bar
- Mechanical Impact Strength IK 08
- Cement Spill Protector

	Ways	Modules	Cat Ref.	Unit Price (₹)
	4 Way compact	4 + 12	811832	3456
	4 Way	8 + 12	811833	3644
	6 Way compact	4 + 18	811834	4222
	6 Way	8 + 18	811835	4512
	8 Way	8 + 24	811836	5340
	12 Way	8 + 36	811837	7680
	16 Way	8 + 48	811838	9460

TPN DB-DOUBLE DOOR

HSN Code: 8537

- IP : 43 Protection
- Door Earthing
- Isolated Neutral Bar
- Mechanical Impact Strength IK 09
- Cement Spill Protector

	Ways	Modules	Cat Ref.	Unit Price (₹)
	4 Way compact	4 + 12	811840	4284
	4 Way	8 + 12	811841	4492
	6 Way compact	4 + 18	811842	5278
	6 Way	8 + 18	811843	5610
	8 Way	8 + 24	811844	6728
	12 Way	8 + 36	811845	10080
	16 Way	8 + 48	811846	12524

TPN DB -DOUBLE DOOR

HSN Code: 8537

- IP : 54 Protection
- Door Earthing
- Isolated Neutral Bar
- Mechanical Impact Strength IK 09
- Cement Spill Protector

	Ways	Modules	Cat Ref.	Unit Price (₹)
	4 Way compact	4 + 12	811856	7990
	4 Way	8 + 12	811857	9026
	6 Way compact	4 + 18	811858	10350
	6 Way	8 + 18	811859	11282
	8 Way	8 + 24	811860	14014
	12 Way	8 + 36	811861	19914
	16 Way	8 + 48	811862	23804

TPN DB-ACRYLIC DOOR

HSN Code: 8537

- IP : 43 Protection
- Door Earthing
- Isolated Neutral Bar
- Cement Spill Protector

	Ways	Modules	Cat Ref.	Unit Price (₹)
	4 Way compact	4 + 12	811848	5362
	4 Way	8 + 12	811849	5838
	6 Way compact	4 + 18	811850	6790
	6 Way	8 + 18	811851	7286
	8 Way	8 + 24	811852	9066
	12 Way	8 + 36	811853	12834
	16 Way	8 + 48	811854	15504

— optipro™ — **DISTRIBUTION BOARDS (DBs)**

VTPN MCB DB-SINGLE DOOR

HSN Code: 8537

- IP : 30 Protection
- Door Earthing
- Isolated Neutral Bar
- Mechanical Impact Strength IK 08
- Insulated busbar assembly

	Ways	Modules	Cat Ref.	Unit Price (₹)
	4 Way	8 + 12	811864	9874
	6 Way	8 + 18	811865	10846
	8 Way	8 + 24	811866	12068
	12 Way	8 + 36	811867	16228

VTPN MCB DB-DOUBLE DOOR

- IP : 43 Protection
- Door Earthing
- Isolated Neutral Bar
- Mechanical Impact Strength IK 09
- Insulated busbar assembly

	Ways	Modules	Cat Ref.	Unit Price (₹)
	4 Way	8 + 12	811870	11096
	6 Way	8 + 18	811871	13186
	8 Way	8 + 24	811872	14470
	12 Way	8 + 36	811873	18526

VTPN MCB DB -DOUBLE DOOR

HSN Code: 8537

- IP : 54 Protection
- Door Earthing
- Isolated Neutral Bar
- Mechanical Impact Strength IK 09
- Cement Spill Protector

	Ways	Modules	Cat Ref.	Unit Price (₹)
	4 Way	8 + 12	811882	16892
	6 Way	8 + 18	811883	21342
	8 Way	8 + 24	811884	25958
	12 Way	8 + 36	811885	32644

VTPN MCCB 125A DB-DOUBLE DOOR

HSN Code: 8537

- IP : 43 Protection
- Door Earthing
- Isolated Neutral Bar
- Mechanical Impact Strength IK 09
- Insulated busbar assembly
- Suitable for MCCB's upto 125A as I/C (Frame1)

	Ways	Modules	Cat Ref.	Unit Price (₹)
	4 Way	Optium F1 + 12	811888	12978
	6 Way	Optium F1 + 18	811889	14676
	8 Way	Optium F1 + 24	811890	16022
	12 Way	Optium F1 + 36	811891	21818

VTPN MCCB 125A DB -DOUBLE DOOR

HSN Code: 8537

- IP : 54 Protection
- Door Earthing
- Isolated Neutral Bar
- Mechanical Impact Strength IK 09
- Cement Spill Protector
- Suitable for MCCB's upto 125A as I/C (Frame1)

	Ways	Modules	Cat Ref.	Unit Price (₹)
	4 Way	Optium F1 + 12	812040	21756
	6 Way	Optium F1 + 18	812041	24612
	8 Way	Optium F1 + 24	812042	26330
	12 Way	Optium F1 + 36	812043	35500

— optipro™ — **DISTRIBUTION BOARDS (DBs)**

VTPN MCCB 250A DB-DOUBLE DOOR

HSN Code: 8537

- IP : 43 Protection
- Door Earthing
- Isolated Neutral Bar
- Mechanical Impact Strength IK 09
- Insulated busbar assembly
- Suitable for MCCB's upto 250A as I/C (Frame 2)

	Ways	Modules	Cat Ref.	Unit Price (₹)
	4 Way	Optium F2 + 12	811893	18196
	6 Way	Optium F2 + 18	811894	19334
	8 Way	Optium F2 + 24	811895	21384
	12 Way	Optium F2 + 36	811896	27200

VTPN MCCB 250A DB -DOUBLE DOOR

HSN Code: 8537

- IP : 54 Protection
- Door Earthing
- Isolated Neutral Bar
- Mechanical Impact Strength IK 09
- Cement Spill Protector
- Suitable for MCCB's upto 250A as I/C (Frame 2)

	Ways	Modules	Cat Ref.	Unit Price (₹)
	4 Way	Optium F2 + 12	812045	35294
	6 Way	Optium F2 + 18	812046	37654
	8 Way	Optium F2 + 24	812047	41628
	12 Way	Optium F2 + 36	812048	46762

FLEXI DB-DOUBLE DOOR

HSN Code: 8537

- IP : 43 Protection
- Door Earthing
- Isolated Neutral Bar
- Mechanical Impact Strength IK 09
- Cement Spill Protector

	Ways	Modules	Cat Ref.	Unit Price (₹)
	14 X 2 Row	28	811912	5858
	14 X 3 Row	42	811913	6976
	14 X 4 Row	56	811915	7742

FLEXI DB -DOUBLE DOOR

HSN Code: 8537

- IP : 54 Protection
- Door Earthing
- Isolated Neutral Bar
- Mechanical Impact Strength IK 09
- Cement Spill Protector

	Ways	Modules	Cat Ref.	Unit Price (₹)
	14 X 2 Row	28	812030	9440
	14 X 3 Row	42	812031	11510
	14 X 4 Row	56	812033	12690

— optipro™ — DISTRIBUTION BOARDS (DBs)

7 SEGMENT DB-DOUBLE DOOR

HSN Code: 8537

- IP : 43 Protection
- Door Earthing
- Isolated Neutral Bar
- Mechanical Impact Strength IK 09
- Compartmentalized solution

	Ways	Modules	Cat Ref.	Unit Price (₹)
	4 Way	8 + 12 + 12	811925	11468
6 Way	8 + 12 + 18	811926	12854	
8 Way	8 + 12 + 24	811927	14490	
12 Way	8 + 12 + 36	811928	17926	
16 Way	8 + 12 + 48	811929	18424	

PHASE SELECTOR DB 40A DOUBLE DOOR

HSN Code: 8537

- IP : 43 Protection
- Door Earthing
- 40 A prefitted selector switch
- Mechanical Impact Strength IK 09
- Isolated Neutral Bar

	Ways	Modules	Cat Ref.	Unit Price (₹)
	4 Way	8 + 12	811940	13580
6 Way	8 + 18	811941	14180	
8 Way	8 + 24	811942	15380	
12 Way	8 + 36	811943	17056	

PHASE SELECTOR DB 63A DOUBLE DOOR

HSN Code: 8537

- IP : 43 Protection
- Door Earthing
- 63 A prefitted selector switch
- Mechanical Impact Strength IK 09
- Isolated Neutral Bar

	Ways	Modules	Cat Ref.	Unit Price (₹)
	4 Way	8 + 12	811950	15670
6 Way	8 + 18	811951	16352	
8 Way	8 + 24	811952	17244	
12 Way	8 + 36	811953	19396	

METAL CLAD P&S

HSN Code: 8537

- IP : 30 Protection
- Without MCBs
- Mechanical Impact Strength IK 08

	Ways	Modules	Cat Ref.	Unit Price (₹)
	20A 2P+E	1 Mod	811955	1532
20A 2P+E	2 Mod	811956	1532	
20A 3P+E	3 Mod	811957	3394	
32A 3P+E	3 Mod	811958	4036	

— optipro™ — **DISTRIBUTION BOARDS (DBs)**

TV/TEL DB

HSN Code: 8537

- IP : 43 Protection
- Door Earthing
- Factory fitted KRONE type TV & TEL socket
- Mechanical Impact Strength IK 09
- Isolated & Shrouded Neutral Bar

	Ways	Modules	Cat Ref.	Unit Price (₹)
	8 Way SPN	8	811963	4574
12 Way SPN	12	811964	5154	
16 Way SPN	16	811965	5878	
4 Way TPN	8 + 12	811967	7618	
6 Way TPN	8 + 18	811983	8570	
8 Way TPN	8 + 24	811968	9604	

PPI DB-DOUBLE DOOR

HSN Code: 8537

- IP : 43 Protection
- Door Earthing
- Isolated Neutral Bar for individual phase
- Mechanical Impact Strength IK 09
- Cement Spill Protector

	Ways	Modules	Cat Ref.	Unit Price (₹)
	Hori 4+2 Way	8 + 6 + 12	811971	7824
Hori 6+2 Way	8 + 6 + 18	811972	9604	
Hori 8+2 Way	8 + 6 + 24	811973	11364	
Hori 12+2 Way	8 + 6 + 36	811998	13998	
Tier 6+2 Way	8 + 6 + 18	811974	9294	
Tier 8+2 Way	8 + 6 + 24	811975	11592	
Tier 12+2 Way	8 + 6 + 36	811976	13806	

PPI DB-DOUBLE DOOR

HSN Code: 8537

- IP :54 Protection
- Door Earthing
- Isolated Neutral Bar
- Mechanical Impact Strength IK 09
- Cement Spill Protector

	Ways	Modules	Cat Ref.	Unit Price (₹)
	Hori 4+2 Way	8 + 6 + 12	812034	14924
Hori 6+2 Way	8 + 6 + 18	812035	18298	
Hori 8+2 Way	8 + 6 + 24	812036	20742	
Tier 6+2 Way	8 + 6 + 18	812037	15132	
Tier 8+2 Way	8 + 6 + 24	812038	18900	
Tier 12+2 Way	8 + 6 + 36	812039	21984	

PLASTIC P&S

HSN Code: 8537

- IP : 30 Protection
- Without MCBs

	Ways	Modules	Cat Ref.	Unit Price (₹)
	16A 2P + E	2 Mod	811959	3084
32A 2P + E	2 Mod	811960	3168	
32A 3P + N + E	4 Mod	811961	5072	
63A 3P + N + E	4 Mod	811962	13372	

— optipro™ — **DISTRIBUTION BOARDS (DBs)**

ENCLOSURES

HSN Code: 8537

	Ways	Modules	Cat Ref.	Unit Price (₹)
	1/2 Mod plastic	2	811977	206
	3/4 Mod plastic	4	811978	352
	1 Mod metal	1	811979	518
	2 Mod metal	2	811980	518
	3 Mod metal	3	811981	684
	4 Mod metal	4	811982	684

CABLE END BOX

HSN Code: 8537

• IP : 43 Protection

• Mechanical Impact Strength IK08

Description	Cat Ref.	Unit Price (₹)
CEB SPN DD 4W DB	812000	910
CEB SPN DD 6W DB	812001	972
CEB SPN DD 8W DB	812002	1036
CEB SPN DD 10W DB	812003	1160
CEB SPN DD 12W DB	812004	1222
CEB SPN DD 14W DB	812005	1304
CEB SPN DD 16W DB	812006	1470
CEB SPN DD 18W DB	812007	1574
CEB TPN DD 4W 4 POLE I/C DB	812008	1118
CEB TPN DD 4W 8 POLE I/C DB or CEB TPN 6W4P I/C DB	812009	1346
CEB TPN DD 6W 8P I/C DB or PPI HORI. DD DB 4+2W	812010	1594
CEB TPN DD 8W DB or PPI HORI. DD DB 6+2W	812011	1966
CEB TPN DD 10W DB or PPI HORI. DD DB 8+2W	812012	2298
CEB TPN DD 12W DB	812013	2692
CEB TPN DD 16W DB	812014	2754
CEB VTPN MCCB I/C DB or VTPN MCCB I/C DD DB	812015	2152
CEB FLEXY DD 14 MOD. PER ROW DB	812017	1946
CEB PPI TIER 6+2W	812018	1926
CEB PPI TIER 8+2W	812019	2278
CEB PPI TIER 12+2W	812020	2402

MCCB ENCLOSURE

• Solid Neutral Link for 3 Pole MCCBs

Description	Pack	Cat. Nos.	Unit Price (₹)
Optipro Enclosure for Frame-1 Optium 3 Pole MCCB	1	811984	1884
Optipro Enclosure for Frame-1 Optium 4 Pole MCCB	1	811985	1884
Optipro Enclosure for Frame-2 Optium 3 Pole MCCB	1	811986	2918
Optipro Enclosure for Frame-2 Optium 4 Pole MCCB	1	811987	2918
Optipro Enclosure for Frame-3 Optium 3 Pole MCCB	1	811988	2918
Optipro Enclosure for Frame-3 Optium 4 Pole MCCB	1	811989	2918
Optipro Enclosure for Frame-4 Optium 3 Pole MCCB	1	811990	7266
Optipro Enclosure for Frame-4 Optium 4 Pole MCCB	1	811991	7266

**BUSBAR CHAMBER
TPN BBC (Cu-Busbar)**

HSN Code: 8536

	<p>Solution for safe Power Distribution</p> <ul style="list-style-type: none"> • Step type design • Available in both SPN & TPN configuration 	Item Description	Ingress Protection*	Cat Ref.	Unit Price* (₹)
		Spl. 32A TPN BBC (Cu) with 4 o/g ways	IP42	CPPI1015	7690
		Spl. 63A TPN BBC (Cu) with 4 o/g ways	IP42	CPPI1016	8578
		Spl. 100A TPN BBC (Cu) with 4 o/g ways	IP42	CPPI1017	9502
		Spl. 200A TPN BBC (Cu) with 4 o/g ways	IP42	CPPI1018	11754
		Spl. 250A TPN BBC (Cu) with 4 o/g ways	IP42	CPPI1019	16730
		Spl. 320A TPN BBC (Cu) with 4 o/g ways	IP42	CPPI1020	20326
		Spl. 400A TPN BBC (Cu) with 4 o/g ways	IP42	CPPI1021	22584
		Spl. 630A TPN BBC (Cu) with 4 o/g ways	IP42	CPPI1022	36130

*Also available in IP54 design

**BUSBAR CHAMBER
TPN-Type (Al.Busbar)**

HSN Code: 8536

	<p>Solution for safe Power Distribution</p> <ul style="list-style-type: none"> • Step type design • Available in both SPN & TPN configuration 	Item Description	Ingress Protection*	Cat Ref.	Unit Price* (₹)
		Spl. 32A TPN BBC (Al.) with 4 o/g ways	IP42	CPPI1023	7228
		Spl. 63A TPN BBC (Al.) with 4 o/g ways	IP42	CPPI1024	7690
		Spl. 100A TPN BBC (Al.) with 4 o/g ways	IP42	CPPI1025	8114
		Spl. 200A TPN BBC (Al.) with 4 o/g ways	IP42	CPPI1026	8578
		Spl. 250A TPN BBC (Al.) with 4 o/g ways	IP42	CPPI1027	10368
		Spl. 320A TPN BBC (Al.) with 4 o/g ways	IP42	CPPI1028	11292
		Spl. 400A TPN BBC (Al.) with 4 o/g ways	IP42	CPPI1029	11754
		Spl. 630A TPN BBC (Al.) with 4 o/g ways	IP42	CPPI1008	20202

*Also available in IP54 design

**METAL CLAD PLUG & SOCKET
AC PLUG**

HSN Code: 8536

	Rating	Pack	Cat. Nos.	Unit Price (₹)
	10A 2P+E, 230V AC	1/10/100	810385	178
	20A 2P+E, 230V AC	1/10/100	810386	192
	20A 3P+E, 230V / 415V AC	1/10/100	810387	258
	32A 3P+E, 230V / 415V AC	1/10/100	810388	468

AC SOCKET

HSN Code: 8536

	Rating	Pack	Cat. Nos.	Unit Price (₹)
	10A 2P+E, 230V AC	1/10/100	810389	178
	20A 2P+E, 230V AC	1/10/100	810390	204
	20A 3P+E, 230V / 415V AC	1/10/100	810391	270
	32A 3P+E, 230V / 415V AC	1/10/100	810392	468

TIME SWITCHES

ANALOG TIME SWITCHES (with battery back up)

HSN Code: 9107

	Model Name	Description	Cat Ref.	Unit Price (₹)
	1mod DIN Daily	1P Module, 24 hours program, Programmable every 15 min., backup of 100 hours, current capacity 16A, with 1 changeover (1 CO)	TA916422	3792
	3mod DIN Daily	3P Module, 24 hours program, Programmable every 15 min., backup of 100 hrs., current capacity 16A, with 1 changeover (1 CO)	TA926453	4130
	Front Mounted Daily	Front Mounting, 24 hours program, Programmable every 20 min., back up of 100 hrs., current capacity 16A, with 1 changeover (1 CO)	TA912472*	3792
	3mod DIN Weekly	Weekly program, Programmable every 4 hrs., with back up of 100 hrs., current capacity 16A, with 1 changeover (1 CO)	TA926129*	4512

*Discontinued product, available till stock lasts.

ANALOG TIME SWITCHES (without battery back up)

HSN Code: 9107

	Model Name	Description	Cat Ref.	Unit Price (₹)
	3mod DIN Daily	3P Module, 24 hours program, Programmable every 15 min., current capacity 16A, with 1 changeover (1 CO)	TA925450*	3486
	Front Mounted Daily	Front Mounting, 24 hours program, Programmable every 20 min., current capacity 16A, with 1 changeover (1 CO)	TA912473*	3138

*Discontinued product, available till stock lasts.

DIGITAL TIME SWITCHES

HSN Code: 9107

	Model Name	Description	Cat Ref.	Unit Price (₹)
	DIN Type Daily / Weekly with 1 CO	Programmable every 1 min., with backup of 6 years, 28 memory locations, current capacity 16A, weekly program, with 1 changeover (1 CO), Total 28 programs	TDA43110	5020
	DIN Type Daily / Weekly with 2 CO	Programmable every 1 min., with backup of 6 years, 28 memory locations, current capacity 16A, weekly program, with 2 changeover (2 CO), Total 14 programs per channel	TDA43111	7534
	DIN Type Astronomical with 1 CO	Astronomical Programmable every 1 min., backup of 6 years, 28 memory locations, current capacity 16A, with 1 changeover (1 CO), Total 28 programs	TDA45163	10450
	DIN Type Astronomical with 2 CO	Astronomical Programmable every 1 min., backup of 6 years, 28 memory locations, current capacity 16A, with 2 changeover (2 CO), Total 14 programs per channel	TDA45164	13058

LIGHT SENSITIVE SWITCHES

HSN Code: 9107

	Model Name	Description	Cat Ref.	Unit Price (₹)
	1mod DIN Light	Light sensitive switch with outer sensor, sensitive distance 50m,	TSA58107	8708

TIMELITE DISTRIBUTION BOARDS

HSN Code: 8537

Description	Cat Ref.	Unit Price (₹)
Timelite-16A 3Pole/230V-Analog Time switch	TL016AB0	24492
Timelite-32A 3Pole/230V-Analog Time switch	TL032AB0	26494
Timelite-32A 3Pole/230V-Digital Time Switch	TL032DB0	28914
Timelite-32A 3Pole/230V-Astronomical Time Switch	TL032AS0	33742
Timelite-40A 3Pole/230V-Analog Time Switch	TL040AB0	28540
Timelite-40A 3Pole/230V-Digital Time Switch	TL040DB0	30910
Timelite-40A 3Pole/230V-Astronomical Time Switch	TL040AS0	35742
Timelite-65A 3Pole/230V-Analog Time Switch	TL065AB0	36534
Timelite-65A 3Pole/230V-Digital Time Switch	TL065DB0	38948
Timelite-65A 3Pole/230V-Astronomical Time Switch	TL065AS0	43756
Timelite-110A 3Pole/230V-Analog Time Switch	TL110AB0	61162
Timelite-110A 3Pole/230V-Digital Time Switch	TL110DB0	63026
Timelite-110A 3Pole/230V-Astronomical Time Switch	TL110AS0	68484
The analog time switch which will be used in Timelite DBs is TA926453 The digital time switch which will be used in Timelite DBs is TDA43110 The astronomical time switch which will be used in Timelite DBs is TDA45163		

GSM based SMART Timelite DB's are also available on request.

AUTOMATIC CHANGEOVER WITH CURRENT LIMITER

- As per IEC60947-6-1
- Intelligent micro controller based Design
- RoHS Compliant

HSN Code: 8536

Rating (A)	Pack	Cat. Nos.	Unit Price (₹)
SPN 30A Mains 1.5A DG ACCL	1/3/45	810409	2048
SPN 30A Mains 2.5A DG ACCL	1/3/45	810410	2048
SPN 30A Mains 3A DG ACCL	1/3/45	810400	2048
SPN 30A Mains 4A DG ACCL	1/3/45	810401	2048
SPN 30A Mains 5A DG ACCL	1/3/45	810402	2048
SPN 30A Mains 6A DG ACCL	1/3/45	810403	2048
SPN 30A Mains 9A DG ACCL	1/3/45	810404	2048
SPN 30A Mains 12A DG ACCL	1/3/45	810405	2048
SPN 30A Mains 15A DG ACCL	1/3/45	810406	2048
SPN 30A Mains 20A DG ACCL	1/3/45	810407	2048
SPN 30A Mains 30A DG ACCL	1/3/45	810408	2048

—optium™— **OPTIUM 1.0E (FIXED TM MCCB RANGE)**

- Ics =50% Icu as per IEC 60947-II
- Suitable for isolation
- Class II front face
- Fixed Overload & fixed short circuit setting

HSN Code: 8536

	Frame	Breaking capacity	Rating	3P	Unit Price (₹)	4P	Unit Price (₹)
	F1	10kA	16	830701	2664	830710	3234
	F1	10kA	25	830702	2664	830711	3234
	F1	10kA	32	830703	2664	830712	3234
	F1	10kA	40	830704	2664	830713	3234
	F1	10kA	50	830705	2664	830714	3234
	F1	10kA	63	830706	2664	830715	3234
	F1	10kA	80	830707	3002	830716	3842
	F1	10kA	100	830708	3002	830717	3842
	F1	10kA	125	830709	4302	830718	5558

HSN Code: 8536

	Frame	Breaking capacity	Rating	3P	Unit Price (₹)	4P	Unit Price (₹)
	F1	16kA	16	830001	4436	830015	5418
	F1	16kA	25	830002	4436	830016	5418
	F1	16kA	32	830003	4436	830017	5418
	F1	16kA	40	830004	4436	830018	5418
	F1	16kA	50	830005	4436	830019	5418
	F1	16kA	63	830006	4436	830020	5418
	F1	16kA	80	830007	4658	830021	5998
	F1	16kA	100	830008	4658	830022	5998
	F1	16kA	125	830009	6454	830023	8484

HSN Code: 8536

	Frame	Breaking capacity	Rating	3P	Unit Price (₹)	4P	Unit Price (₹)
	F1	25kA	16	830031	5340	830045	6382
	F1	25kA	25	830032	5340	830046	6382
	F1	25kA	32	830033	5340	830047	6382
	F1	25kA	40	830034	5340	830048	6382
	F1	25kA	50	830035	5340	830049	6382
	F1	25kA	63	830036	5340	830050	6382
	F1	25kA	80	830037	5498	830051	6700
	F1	25kA	100	830038	5498	830052	6700
	F1	25kA	125	830039	6620	830053	8812

HSN Code: 8536

	Frame	Breaking capacity	Rating	3P	Unit Price (₹)	4P	Unit Price (₹)
	F1	36kA	16	830061	7068	830075	8084
	F1	36kA	25	830062	7068	830076	8084
	F1	36kA	32	830063	7068	830077	8084
	F1	36kA	40	830064	7068	830078	8084
	F1	36kA	50	830065	7068	830079	8084
	F1	36kA	63	830066	7068	830080	8084
	F1	36kA	80	830067	7176	830081	8520
	F1	36kA	100	830068	7176	830082	8520
	F1	36kA	125	830069	9888	830083	10278

—optium™— **OPTIUM 1.0 (FIXED TM MCCB RANGE)**

HSN Code: 8536

	Frame	Breaking capacity	Rating	3P	Unit Price (₹)	4P	Unit Price (₹)
	F3	50kA	16	830125	8536	830145	10378
	F3	50kA	25	830126	8536	830146	10378
	F3	50kA	32	830127	8536	830147	10378
	F3	50kA	40	830128	8536	830148	10378
	F3	50kA	50	830129	8536	830149	10378
	F3	50kA	63	830130	8536	830150	10378
	F3	50kA	80	830131	8966	830151	10692
	F3	50kA	100	830132	8966	830152	10692
	F3	50kA	125	830133	10460	830153	13264

HSN Code: 8536

	Frame	Breaking capacity	Rating	3P	Unit Price (₹)	4P	Unit Price (₹)
	F2	16kA	160	830090	6992	830095	10096
	F2	16kA	200	830091	9008	830096	11728
	F2	16kA	250	830092	9940	830097	12386
	F2	25kA	160	830100	8238	830105	10362
	F2	25kA	200	830101	11394	830106	13784
	F2	25kA	250	830102	14702	830107	17282
	F2	36kA	160	830110	10376	830115	12716
	F2	36kA	200	830111	13290	830116	16792
F2	36kA	250	830112	17348	830117	22814	

HSN Code: 8536

	Frame	Breaking capacity	Rating	3P	Unit Price (₹)	4P	Unit Price (₹)
	F3	50kA	160	830134	11702	830154	16068
	F3	50kA	200	830135	14084	830155	19772
F3	50kA	250	830136	18114	830156	24064	

HSN Code: 8536

	Frame	Breaking capacity	Rating	3P	Unit Price (₹)	4P	Unit Price (₹)
	F4	36kA	315	830165	23652	830175	26984
	F4	36kA	400	830166	24998	830176	28516
	F4	36kA	500	830167	27972	830177	32368
F4	36kA	630	830168	29648	830178	34070	

HSN Code: 8536

	Frame	Breaking capacity	Rating	3P	Unit Price (₹)	4P	Unit Price (₹)
	F4	50kA	315	830185	24346	830195	28866
	F4	50kA	400	830186	26572	830196	31180
	F4	50kA	500	830187	28892	830197	33510
F4	50kA	630	830188	30626	830198	34724	

HSN Code: 8536

	Frame	Breaking capacity	Rating	3P	MRP	4P	MRP
F5	50kA	800	830200	39518	830201	51046	

—optium™— **OPTIUM 1.1 (FIXED TM MCCB RANGE)**

- Ics = 100% Icu as per IEC 60947-II
- Suitable for isolation
- Class II front face
- Fixed Overload & fixed short circuit setting

HSN Code: 8536

	Frame	Breaking capacity	Rating	3P	Unit Price (₹)	4P	Unit Price (₹)
		F1	16kA	32	840003	4618	840017
	F1	16kA	40	840004	4618	840018	6060
	F1	16kA	63	840006	4618	840020	6060
	F1	16kA	80	840007	4798	840021	6482
	F1	16kA	100	840008	4798	840022	6482
	F1	16kA	125	840009	6730	840023	9046
	F1	25kA	32	840033	5602	840047	7096
	F1	25kA	40	840034	5602	840048	7096
	F1	25kA	63	840036	5602	840050	7096
	F1	25kA	80	840037	5936	840051	7234
	F1	25kA	100	840038	5936	840052	7234
	F1	25kA	125	840039	6868	840053	10148
	F2	16kA	160	840090	7356	840095	10968
	F2	16kA	200	840091	9236	840096	12260
	F2	16kA	250	840092	10526	840097	14052
	F2	25kA	160	840100	8564	840105	11316
	F2	25kA	200	840101	12016	840106	14440
	F2	25kA	250	840102	15534	840107	19412

—optium™— **OPTIUM 2.0 (ADJUSTABLE THERMAL SETTING MCCB)**

- Conforms to IEC 60947-II
- Adjustable Overload Setting $I_r = (0.8 \text{ to } 1.0) \times I_n$
- Ics = 100% Icu
- Class II front face
- Short Circuit setting fixed
- Suitable for isolation

HSN Code: 8536

	Frame	Breaking capacity	Rating	3P	Unit Price (₹)	4P	Unit Price (₹)
		F1	16kA	25	830222	4698	830236
	F1	16kA	32	830223	4698	830237	6274
	F1	16kA	40	830224	4698	830238	6274
	F1	16kA	50	830225	4698	830239	6274
	F1	16kA	63	830226	4698	830240	6274
	F1	16kA	80	830227	5094	830241	6746
	F1	16kA	100	830228	5094	830242	6746
	F1	16kA	125	830229	6954	830243	9400

HSN Code: 8536

	Frame	Breaking capacity	Rating	3P	Unit Price (₹)	4P	Unit Price (₹)
		F1	25kA	25	830252	5892	830266
	F1	25kA	32	830253	5892	830267	7418
	F1	25kA	40	830254	5892	830268	7418
	F1	25kA	50	830255	5892	830269	7418
	F1	25kA	63	830256	5892	830270	7418
	F1	25kA	80	830257	6182	830271	7782
	F1	25kA	100	830258	6182	830272	7782
	F1	25kA	125	830259	7154	830273	10648

HSN Code: 8536

	Frame	Breaking capacity	Rating	3P	Unit Price (₹)	4P	Unit Price (₹)
		F2	16kA	160	830280	7716	830285
	F2	16kA	200	830281	9616	830286	12730
	F2	16kA	250	830282	11130	830287	15040
	F2	25kA	160	830290	9766	830295	12812
	F2	25kA	200	830291	12500	830296	16128
	F2	25kA	250	830292	16712	830297	20900

—optium™— **OPTIUM 2.0 (ADJUSTABLE TM MCCB RANGE)**

- Ics =100% Icu as per IEC 60947-II
- Adjustable Overload Setting Ir =(0.8 to 1.0)×In
- Class II front face
- Adjustable Short Circuit Setting Isd =[5 -10]×In
- Suitable for isolation

HSN Code: 8536

	Frame	Breaking capacity	Rating	3P		4P	
				Unit Price (₹)		Unit Price (₹)	
	F3	36kA	16	830305	7958	830325	10996
	F3	36kA	25	830306	7958	830326	10996
	F3	36kA	32	830307	7958	830327	10996
	F3	36kA	40	830308	7958	830328	10996
	F3	36kA	50	830309	7958	830329	10996
	F3	36kA	63	830310	7958	830330	10996
	F3	36kA	80	830311	8114	830331	11320
	F3	36kA	100	830312	8114	830332	11320
	F3	36kA	125	830313	10418	830333	12682

HSN Code: 8536

	Frame	Breaking capacity	Rating	3P		4P	
				Unit Price (₹)		Unit Price (₹)	
	F3	50kA	16	830345	10714	830365	12806
	F3	50kA	25	830346	10714	830366	12806
	F3	50kA	32	830347	10714	830367	12806
	F3	50kA	40	830348	10714	830368	12806
	F3	50kA	50	830349	10714	830369	12806
	F3	50kA	63	830350	10714	830370	12806
	F3	50kA	80	830351	10930	830371	12934
	F3	50kA	100	830352	10930	830372	12934
	F3	50kA	125	830353	12026	830373	15440

HSN Code: 8536

	Frame	Breaking capacity	Rating	3P		4P	
				Unit Price (₹)		Unit Price (₹)	
	F3	36kA	160	830314	13294	830334	15818
	F3	36kA	200	830315	14908	830335	20640
	F3	36kA	250	830316	19582	830336	27030

HSN Code: 8536

	Frame	Breaking capacity	Rating	3P		4P	
				Unit Price (₹)		Unit Price (₹)	
	F3	50kA	160	830354	13778	830374	17376
	F3	50kA	200	830355	16074	830375	22038
	F3	50kA	250	830356	22816	830376	28466

HSN Code: 8536

	Frame	Breaking capacity	Rating	3P		4P	
				Unit Price (₹)		Unit Price (₹)	
	F4	25kA	315	830385	20822	830387	26224
	F4	25kA	400	830386	21320	830388	28610
	F4	36kA	315	830390	25022	830395	30476
	F4	36kA	400	830391	26620	830396	32814
	F4	36kA	500	830392	31028	830397	38470
	F4	36kA	630	830393	33708	830398	43092
	F4	50kA	315	830400	26718	830405	33002
	F4	50kA	400	830401	28516	830406	34654
	F4	50kA	500	830402	32664	830407	40630
	F4	50kA	630	830403	35314	830408	45076

—optium™— **OPTIUM 2.0 (ADJUSTABLE TM MCCB RANGE)**

HSN Code: 8536

	Frame	Breaking capacity	Rating	3P	Unit Price (₹)	4P	Unit Price (₹)
	F5	36kA	800	830410	40784	830413	50012
	F5	36kA	1000	830411	58738	830414	67188
	F5	36kA	1250	830412	67934	830415	80738
	F5	50kA	800	830416	41986	830419	59820
	F5	50kA	1000	830417	73020	830420	78304
	F5	50kA	1250	830418	80536	830421	90696

—optium™— **OPTIUM 2.1 (ELECTRONIC / MICRO -PROCESSOR MCCB RANGE)**

- Ics =100% Icu as per IEC 60947-II
- Class II front face
- Suitable for isolation
- Adjustable Overload Setting $I_r = (0.4 - 1) \times I_n$
- Adjustable Short circuit Current Setting $I_{sd} = 1.5 - 10 \times I_r$

HSN Code: 8536

	Frame	Breaking capacity	Rating	3P	Unit Price (₹)	4P	Unit Price (₹)
	F3	36kA	40	830430	16946	830440	21342
	F3	36kA	100	830431	17256	830441	21730
	F3	36kA	160	830432	21092	830442	25358
	F3	36kA	250	830433	26614	830443	32280
	F3	50kA	40	830450	18948	830460	22754
	F3	50kA	100	830451	20210	830461	24286
	F3	50kA	160	830452	22996	830462	28120
F3	50kA	250	830453	30250	830463	37066	

—optium™— **OPTIUM 2.1 (ELECTRONIC / MICRO -PROCESSOR MCCB RANGE)**

- Ics =100% Icu as per IEC 60947-II
- Class II front face
- Suitable for isolation
- Transparent cover for trip unit as standard
- Adjustable Neutral pole protection -N,N/2 & Off for 4 pole MCCB
- Innovative front indication LED's(Ready, Overload pre-alarm & Overload)
- Adjustable Overload Setting $I_r = (0.4 - 1) \times I_n$; $T_r = 3-30$ sec
- Adjustable Short circuit Current Setting $I_{sd} = (1.5 - 10) I_r$; $T_{sd} (I=K) = 0-500$ ms; $T_{sd} (I2t=K) = 0-500$ ms

HSN Code: 8536

	Frame	Breaking capacity	Rating	3P	Unit Price (₹)	4P	Unit Price (₹)
	F4	36kA	400	830510	32136	830512	42378
	F4	36kA	630	830511	36210	830513	46008
	F4	50kA	400	830514	39728	830516	50524
F4	50kA	630	830515	41144	830517	53338	

HSN Code: 8536

	Frame	Breaking capacity	Rating	3P	Unit Price (₹)	4P	Unit Price (₹)
	F5	36kA	800	830540	58752	830542	71240
	F5	36kA	1250	830541	88348	830543	112552
	F5	50kA	800	830544	62722	830546	78250
F5	50kA	1250	830545	107854	830547	149104	

—optium™— **OPTIUM 2.2 (WITH ELECTRONIC / MICRO PROCESSOR RELEASE)**

- Ics =100% Icu as per IEC 60947-II
- Class II front face
- Suitable for isolation
- Adjustable Overload Setting $I_r = (0.4 - 1) \times I_n$
- Adjustable Short circuit Current Setting $I_{sd} = (1.5 - 10) \times I_r$
- Ground fault Setting:- $I_g = (0.2 - 1) \times I_n$

HSN Code: 8536

	Frame	Breaking capacity	Rating	3P	Unit Price (₹)	4P	Unit Price (₹)
	F3	36kA	40	830470	20142	830480	25176
	F3	36kA	100	830471	20684	830481	25850
	F3	36kA	160	830472	23236	830482	28790
	F3	36kA	250	830473	29692	830483	36536
	F3	50kA	40	830490	21946	830500	26554
	F3	50kA	100	830491	22534	830501	26904
	F3	50kA	160	830492	25816	830502	31346
F3	50kA	250	830493	33560	830503	40414	

—optium™— **OPTIUM 2.2 (ELECTRONIC / MICRO -PROCESSOR MCCB RANGE)**

- Ics =100% Icu as per IEC 60947-II
- Class II front face
- Suitable for isolation
- Adjustable Neutral pole protection –N,N/2 & Off for 4 pole MCCB
- Innovative front indication LED's(Ready, Overload pre-alarm & Overload)
- Adjustable Overload Setting Ir = 0.4 - 1 x In ; Tr = 3-30 sec
- Adjustable Short circuit Current Setting I_{sd} = 1.5 - 10 Ir ; T_{sd} (I=K) = 0-500 ms; T_{sd} (I2t=K) = 0-500 ms
- Ground fault Setting:- Ig = (0.2 - 1) x In ; Tg = (0.1 - 1) s

HSN Code: 8536

	Frame	Breaking capacity	Rating	3P	Unit Price (₹)	4P	Unit Price (₹)
	F4	36kA	400	830520	42734	830522	50668
	F4	36kA	630	830521	48838	830523	62266
	F4	50kA	400	830524	47938	830526	55194
	F4	50kA	630	830525	54184	830527	69144

HSN Code: 8536

	Frame	Breaking capacity	Rating	3P	Unit Price (₹)	4P	Unit Price (₹)
	F5	36kA	800	830550	73582	830552	92948
	F5	36kA	1250	830551	98114	830553	128450
	F5	50kA	800	830554	87786	830556	108016
	F5	50kA	1250	830555	114892	830557	156500

—optium™— **ACCESSORIES**

HSN Code: 8538

	Product	Frame	Cat Ref.	Unit Price (₹)
	Auxiliary contact	F1 F2 F3	830691	1080
	Alarm Contact	F1 F2 F3	830692	1080
	Auxiliary contact / Alarm Contact	F4-F5	830693	1416
	Auxiliary contact / Alarm Contact	F1 F2 F3	830694	1618

HSN Code: 8538

	Product	Frame	Cat Ref.	Unit Price (₹)
	"Shunt trip 24 V AC/DC"	F1 F2 F3	830602	1224
	"Shunt trip 110 V AC/DC"	F1 F2 F3	830603	1224
	"Shunt trip 230 V AC/DC"	F1 F2 F3	830604	1308
	"Shunt trip 415 V AC/DC"	F1 F2 F3	830605	1308
	"Shunt trip 24 V AC/DC"	F4 F5	830642	2404
	"Shunt trip 110 V AC/DC"	F4 F5	830643	2404
	"Shunt trip 230 V AC/DC"	F4 F5	830644	2404
	"Shunt trip 415 V AC/DC"	F4 F5	830645	2404

HSN Code: 8538

	Product	Frame	Cat Ref.	Unit Price (₹)
	"Undervoltage 24 V DC"	F1 F2 F3	830606	2006
	"Undervoltage 110V AC"	F1 F2 F3	830607	2006
	"Undervoltage 230V AC"	F1 F2 F3	830608	2006
	"Undervoltage 415V AC"	F1 F2 F3	830609	2006
	"Undervoltage 24 V DC"	F4 F5	830646	2136
	"Undervoltage 110V AC"	F4 F5	830647	2136
	"Undervoltage 230V AC"	F4 F5	830648	2136
	"Undervoltage 415V AC"	F4 F5	830649	2136

—optium™— **ACCESSORIES**

HSN Code: 8538

	Product	Frame	Cat Ref.	Unit Price (₹)
	Rotary Handle Direct	F1	830611	1536
	Rotary Handle vary-Depth	F1	830612	1536
	Rotary Handle Direct	F2 F3	830626	1804
	Rotary Handle vary-Depth	F2 F3	830627	1804
	Rotary Handle Direct	F4	830651	2136
	Rotary Handle vary-Depth	F4	830652	2136
	Rotary Handle Direct	F5	830671	4184
	Rotary Handle vary-Depth	F5	830672	4184

HSN Code: 8538

	Product	Frame	Cat Ref.	Unit Price (₹)
	Ronis lock Direct RH	F1 F2 F3	830613	1682
	Ronis lock Vary-Depth RH	F1 F2 F3	830614	1682
	Ronis lock Vary-Depth RH	F4	830653	2270

HSN Code: 8538

	Product	Frame	Cat Ref.	Unit Price (₹)
	Padlock Off position	F1 F2 F3	830615	2292
	Padlock Off position	F4	830654	2292
	Padlock Off position	F5	830674	2292

HSN Code: 8538

	Product	Frame	Cat Ref.	Unit Price (₹)
	Phase insulators 3P	F1 F2	830616	POR
	Phase insulators 3P	F3	830628	POR
	Phase insulators 3P	F4	830655	POR
	Phase insulators 3P	F5	830675	POR
	Phase insulators 4P	F1 F2	830617	POR
	Phase insulators 4P	F3	830629	POR
	Phase insulators 4P	F4	830656	POR
	Phase insulators 4P	F5	830676	POR

** POR - Price on Request.

HSN Code: 8538

	Product	Frame	Cat Ref.	Unit Price (₹)
	Terminal cover 3P	F4	830657	POR
	Terminal cover 3P	F5	830677	POR
	Terminal cover 4P	F4	830658	POR
	Terminal cover 4P	F5	830678	POR
	Terminal shield 3P	F5	830679	POR
	Terminal shield 4P	F5	830680	POR

** POR - Price on Request.

—optium™— **ACCESSORIES**

HSN Code: 8538

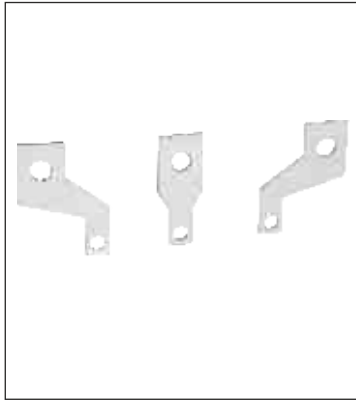

Product	Frame	Cat Ref.	Unit Price (₹)
Spreaders 3P	F1	830618	414
Spreaders 4P	F1	830619	604
Spreaders 3P	F2 F3	830632	1100
Spreaders 4P	F2 F3	830633	2200
Spreaders 3P	F4	830659	3522
Spreaders 4P	F4	830660	5136
Spreaders 3P 800/1000A	F5	830681	9096
Spreaders 4P 800/1000A	F5	830682	13336
Spreaders 3P 1250A	F5	830685	9460
Spreaders 4P 1250A	F5	830686	13944

HSN Code: 8538



Product	Frame	Cat Ref.	Unit Price (₹)
Cages 3P upto 50A	F1	830620	POR
Cages 4P upto 50A	F1	830621	POR
Cages 3P 63 to 100A	F1	830622	POR
Cages 4P 63 to 100A	F1	830623	POR
Cages 3P 125A	F1	830624	POR
Cages 4P 125A	F1	830625	POR
Cages 3P	F2	830630	POR
Cages 4P	F2	830631	POR
Cages 3P	F3	830634	POR
Cages 4P	F3	830635	POR
Cages 3P	F4	830661	POR
Cages 4P	F4	830662	POR
Cages 3P	F5	830683	POR
Cages 4P	F5	830684	POR

** POR - Price on Request.

— optipro[™] SMDB —

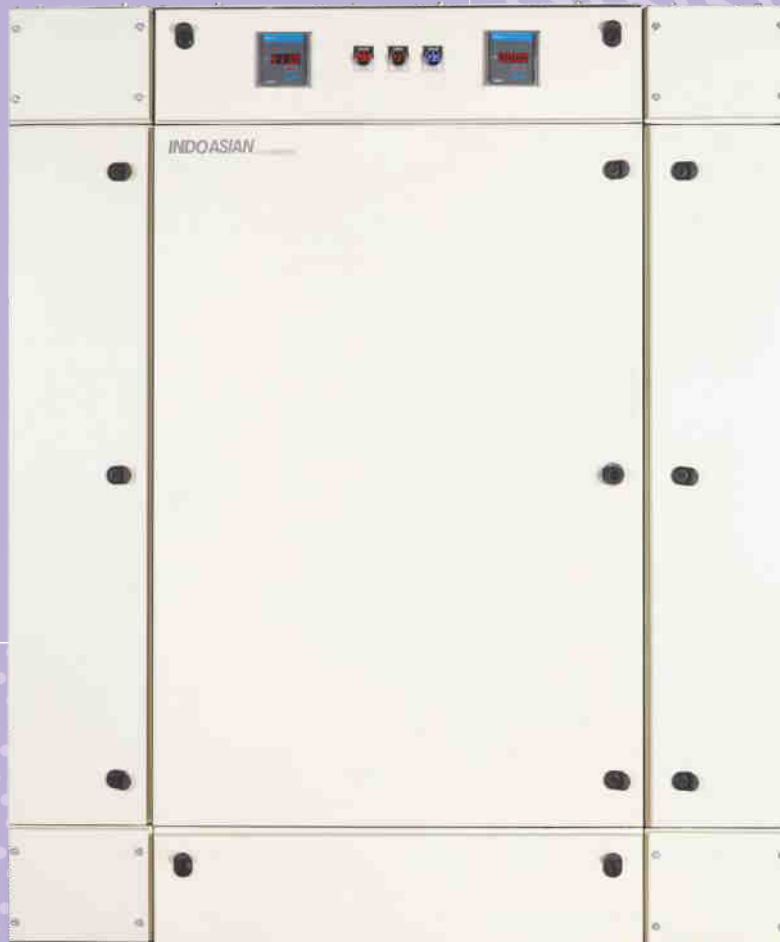

READY TO USE-SAFE-RELIABLE SUB MAIN DISTRIBUTION BOARD



Highly reliable & tested
solution as per IEC
61439



Easy to install



3 frame Sizes: SMDB250,
SMDB400 & SMDB630



*IP43 degree of
protection

Optipro SMDB 250 (Single Door) - Main enclosure (with a provision to mount TP MCCBs as an outgoing*) HSN Code: 8536

- Tested as per IEC 61439-2
- Degree of protection IP-30 in Single door & IP-43 in Double door
- 3 Frame sizes - SMDB250, SMDB400, SMDB630
- wide range- 4W, 6W, 8W & 12W

Item Description	Type	Cat Ref.	Unit Price (₹)
SMDB250 4W SD ME Optium F2-I/c & TP F1 O/G	SD	812100	40120
SMDB250 6W SD ME Optium F2-I/c & TP F1 O/G	SD	812101	43072
SMDB250 8W SD ME Optium F2-I/c & TP F1 O/G	SD	812102	49466
SMDB250 12W SD ME Optium F2-I/c & TP F1 O/G	SD	812103	58464
SMDB250 4W SD ME Optium F3-I/c & TP F1 O/G	SD	812110	43596
SMDB250 6W SD ME Optium F3-I/c & TP F1 O/G	SD	812111	46800
SMDB250 8W SD ME Optium F3-I/c & TP F1 O/G	SD	812112	53750
SMDB250 12W SD ME Optium F3-I/c & TP F1 O/G	SD	812113	63556

Optipro SMDB 400 (Single Door) - Main enclosure (with a provision to mount TP MCCBs as an outgoing*) HSN Code: 8536

Item Description	Type	Cat Ref.	Unit Price (₹)
SMDB400 4W SD ME Optium F4-I/c & TP F1 O/G	SD	812120	44856
SMDB400 6W SD ME Optium F4-I/c & TP F1 O/G	SD	812121	48132
SMDB400 8W SD ME Optium F4-I/c & TP F1 O/G	SD	812122	55440
SMDB400 12W SD ME Optium F4-I/c & TP F1 O/G	SD	812123	65520
SMDB400 8W SD ME Optium F4-I/c & TP F1-6 & F2-0/G	SD	812124	55440
SMDB400 12W SD ME Optium F4-I/c & TP F1-8 & F2-0/G	SD	812125	65520
SMDB400 12W SD ME Optium F4-I/c & TP F1-10 & F2-0/G	SD	812126	65520

Optipro SMDB 630 (Single Door) - Main enclosure (with a provision to mount TP MCCBs as an outgoing*) HSN Code: 8536

Item Description	Type	Cat Ref.	Unit Price (₹)
SMDB630 4W SD ME Optium F4-I/c & TP F1 O/G	SD	812136	67284
SMDB630 6W SD ME Optium F4-I/c & TP F1 O/G	SD	812137	69804
SMDB630 8W SD ME Optium F4-I/c & TP F1 O/G	SD	812138	80388
SMDB630 12W SD ME Optium F4-I/c & TP F1 O/G	SD	812139	95004
SMDB630 8W SD ME Optium F4-I/c & TP F1-6 & F2-0/G	SD	812140	80388
SMDB630 12W SD ME Optium F4-I/c & TP F1-8 & F2-0/G	SD	812141	95004
SMDB630 12W SD ME Optium F4-I/c & TP F1-10 & F2-0/G	SD	812142	95004

Optipro SMDB 250 (Single Door) - Main enclosure (with a provision to mount FP MCCBs as an outgoing*) HSN Code: 8536

Item Description	Type	Cat Ref.	Unit Price (₹)
SMDB250 4W SD ME Optium F2-I/c & FP F1 O/G	SD	812105	44122
SMDB250 6W SD ME Optium F2-I/c & FP F1 O/G	SD	812106	47356
SMDB250 8W SD ME Optium F2-I/c & FP F1 O/G	SD	812107	54432
SMDB250 12W SD ME Optium F2-I/c & FP F1 O/G	SD	812108	64512
SMDB250 4W SD ME Optium F3-I/c & FP F1 O/G	SD	812115	47954
SMDB250 6W SD ME Optium F3-I/c & FP F1 O/G	SD	812116	51514
SMDB250 8W SD ME Optium F3-I/c & FP F1 O/G	SD	812117	59148
SMDB250 12W SD ME Optium F3-I/c & FP F1 O/G	SD	812118	70108

Optipro SMDB 400 (Single Door) - Main enclosure (with a provision to mount FP MCCBs as an outgoing*) HSN Code: 8536

Item Description	Type	Cat Ref.	Unit Price (₹)
SMDB400 4W SD ME Optium F4-I/c & FP F1 O/G	SD	812128	49392
SMDB400 6W SD ME Optium F4-I/c & FP F1 O/G	SD	812129	53172
SMDB400 8W SD ME Optium F4-I/c & FP F1 O/G	SD	812130	60984
SMDB400 12W SD ME Optium F4-I/c & FP F1 O/G	SD	812131	72324
SMDB400 8W SD ME Optium F4-I/c & FP F1-6 & F2-0/G	SD	812132	60984
SMDB400 12W SD ME Optium F4-I/c & FP F1-8 & F2-0/G	SD	812133	72324
SMDB400 12W SD ME Optium F4-I/c & FP F1-10 & F2-0/G	SD	812134	72324

Optipro SMDB 630 (Single Door) - Main enclosure (with a provision to mount FP MCCBs as an outgoing*) HSN Code: 8536

Item Description	Type	Cat Ref.	Unit Price (₹)
SMDB630 4W SD ME Optium F4-I/c & FP F1 O/G	SD	812144	74088
SMDB630 6W SD ME Optium F4-I/c & FP F1 O/G	SD	812145	77112
SMDB630 8W SD ME Optium F4-I/c & FP F1 O/G	SD	812146	88452
SMDB630 12W SD ME Optium F4-I/c & FP F1 O/G	SD	812147	104832
SMDB630 8W SD ME Optium F4-I/c & FP F1-6 & F2-0/G	SD	812148	88452
SMDB630 12W SD ME Optium F4-I/c & FP F1-8 & F2-0/G	SD	812149	104832
SMDB630 12W SD ME Optium F4-I/c & FP F1-10 & F2-0/G	SD	812150	104832

Optipro SMDB 250 (Double Door) - Main enclosure (with a provision to mount TP MCCBs as an outgoing*)

HSN Code: 8536

	Item Description	Type	Cat Ref.	Unit Price (₹)
	SMDB250 4W DD ME Optium F2-I/c & TP F1 O/G	DD	812181	47524
	SMDB250 6W DD ME Optium F2-I/c & TP F1 O/G	DD	812182	51230
	SMDB250 8W DD ME Optium F2-I/c & TP F1 O/G	DD	812183	58896
	SMDB250 12W DD ME Optium F2-I/c & TP F1 O/G	DD	812184	69428
	SMDB250 4W DD ME Optium F3-I/c & TP F1 O/G	DD	812191	49718
	SMDB250 6W DD ME Optium F3-I/c & TP F1 O/G	DD	812192	53552
	SMDB250 8W DD ME Optium F3-I/c & TP F1 O/G	DD	812193	61594
	SMDB250 12W DD ME Optium F3-I/c & TP F1 O/G	DD	812194	72576

Optipro SMDB 400 (Double Door) - Main enclosure (with a provision to mount TP MCCBs as an outgoing*)

HSN Code: 8536

	Item Description	Type	Cat Ref.	Unit Price (₹)
	SMDB400 4W DD ME Optium F4-I/c & TP F1 O/G	DD	812201	51156
	SMDB400 6W DD ME Optium F4-I/c & TP F1 O/G	DD	812202	55188
	SMDB400 8W DD ME Optium F4-I/c & TP F1 O/G	DD	812203	63504
	SMDB400 12W DD ME Optium F4-I/c & TP F1 O/G	DD	812204	74844
	SMDB400 8W DD ME Optium F4-I/c & TP F1-6 & F2-2 O/G	DD	812205	63504
	SMDB400 12W DD ME Optium F4-I/c & TP F1-8 & F2-4 O/G	DD	812206	74844
	SMDB400 12W DD ME Optium F4-I/c & TP F1-10 & F2-2 O/G	DD	812207	74844

Optipro SMDB 630 (Double Door) - Main enclosure (with a provision to mount TP MCCBs as an outgoing*)

HSN Code: 8536

	Item Description	Type	Cat Ref.	Unit Price (₹)
	SMDB630 4W DD ME Optium F4-I/c & TP F1 O/G	DD	812217	78860
	SMDB630 6W DD ME Optium F4-I/c & TP F1 O/G	DD	812218	80136
	SMDB630 8W DD ME Optium F4-I/c & TP F1 O/G	DD	812219	91980
	SMDB630 12W DD ME Optium F4-I/c & TP F1 O/G	DD	812220	108612
	SMDB630 8W DD ME Optium F4-I/c & TP F1-6 & F2-2 O/G	DD	812221	91980
	SMDB630 12W DD ME Optium F4-I/c & TP F1-8 & F2-4 O/G	DD	812222	108612
	SMDB630 12W DD ME Optium F4-I/c & TP F1-10 & F2-2 O/G	DD	812223	108612

Optipro SMDB 250 (Double Door) - Main enclosure (with a provision to mount FP MCCBs as an outgoing*)

HSN Code: 8536

	Item Description	Type	Cat Ref.	Unit Price (₹)
	SMDB250 4W DD ME Optium F2-I/c & FP F1 O/G	DD	812186	52292
	SMDB250 6W DD ME Optium F2-I/c & FP F1 O/G	DD	812187	56343
	SMDB250 8W DD ME Optium F2-I/c & FP F1 O/G	DD	812188	64786
	SMDB250 12W DD ME Optium F2-I/c & FP F1 O/G	DD	812189	76536
	SMDB250 4W DD ME Optium F3-I/c & FP F1 O/G	DD	812196	54736
	SMDB250 6W DD ME Optium F3-I/c & FP F1 O/G	DD	812197	58916
	SMDB250 8W DD ME Optium F3-I/c & FP F1 O/G	DD	812198	67736
	SMDB250 12W DD ME Optium F3-I/c & FP F1 O/G	DD	812199	79990

Optipro SMDB 400 (Double Door) - Main enclosure (with a provision to mount FP MCCBs as an outgoing*)

HSN Code: 8536

	Item Description	Type	Cat Ref.	Unit Price (₹)
	SMDB400 4W DD ME Optium F4-I/c & FP F1 O/G	DD	812209	56448
	SMDB400 6W DD ME Optium F4-I/c & FP F1 O/G	DD	812210	60732
	SMDB400 8W DD ME Optium F4-I/c & FP F1 O/G	DD	812211	69804
	SMDB400 12W DD ME Optium F4-I/c & FP F1 O/G	DD	812212	82404
	SMDB400 8W DD ME Optium F4-I/c & FP F1-6 & F2-2 O/G	DD	812213	69804
	SMDB400 12W DD ME Optium F4-I/c & FP F1-8 & F2-4 O/G	DD	812214	82404
	SMDB400 12W DD ME Optium F4-I/c & FP F1-10 & F2-2 O/G	DD	812215	82404

Optipro SMDB 630 (Double Door) - Main enclosure (with a provision to mount FP MCCBs as an outgoing*)

HSN Code: 8536

	Item Description	Type	Cat Ref.	Unit Price (₹)
	SMDB630 4W DD ME Optium F4-I/c & FP F1 O/G	DD	812225	84672
	SMDB630 6W DD ME Optium F4-I/c & FP F1 O/G	DD	812226	87948
	SMDB630 8W DD ME Optium F4-I/c & FP F1 O/G	DD	812227	101304
	SMDB630 12W DD ME Optium F4-I/c & FP F1 O/G	DD	812228	119448
	SMDB630 8W DD ME Optium F4-I/c & FP F1-6 & F2-2 O/G	DD	812229	101304
	SMDB630 12W DD ME Optium F4-I/c & FP F1-8 & F2-4 O/G	DD	812230	119448
	SMDB630 12W DD ME Optium F4-I/c & FP F1-10 & F2-2 O/G	DD	812231	119448

Optipro SMDB - Bottom cable Unit (Single Door)

HSN Code: 8536

	Item Description	Type	Cat Ref.	Unit Price (₹)
	Bottom Cable Unit(for SD SMDB's with F1 O/G only)	SD	812152	4810
	Bottom Cable Unit(for SD SMDB's with F1 & F2 O/G)	SD	812153	5420

Optipro SMDB 250 - Cable Alley Unit (Single Door)

HSN Code: 8536

	Item Description	Type	Cat Ref.	Unit Price (₹)
	SMDB250 Cable Alley-4W SD	SD	812154	11392
	SMDB250 Cable Alley-6W SD	SD	812155	13430
	SMDB250 Cable Alley-8W SD	SD	812156	14510
	SMDB250 Cable Alley-12W SD	SD	812157	16360

Optipro SMDB 400/630 - Cable Alley (Single Door)

HSN Code: 8536

	Item Description	Type	Cat Ref.	Unit Price (₹)
	SMDB400/630 Cable Alley-4W SD	SD	812159	15876
	SMDB400/630 Cable Alley-6W SD	SD	812160	17494
	SMDB400/630 Cable Alley-8W SD	SD	812161	18922
	SMDB400/630 Cable Alley-12W SD	SD	812162	20738
	SMDB400/630 Cable Alley-8W SD	SD	812163	18922
	SMDB400/630 Cable Alley-12W SD	SD	812164	20738
	SMDB400/630 Cable Alley-12W SD	SD	812165	20738
	Metering Unit(for SD SMDB's with F1 O/G only)- with Ammeter,Voltmeter & Phase Indicators(3nos.)	SD	812167	15928
	Metering Unit (for SD SMDB's with F1 & F2 O/G) - with Ammeter,Voltmeter & Phase Indicators(3nos.)	SD	812168	17264
	Metering Unit(for SD SMDB's with F1 O/G only)- with Multifunction meter, Buzzer & Phase Indicators(3nos.)	SD	812169	19908
	Metering Unit (for SD SMDB's with F1 & F2 O/G) - with Multifunction meter, Buzzer & Phase Indicators(3nos.)	SD	812170	21600
	Corner Unit-SD	SD	812171	1912

Optipro SMDB - Bottom cable Unit (Double Door)

HSN Code: 8536

	Item Description	Type	Cat Ref.	Unit Price (₹)
	Bottom Cable Unit(for DD SMDB's with F1 O/G only)	DD	812233	5398
	Bottom Cable Unit(for DD SMDB's with F1 & F2 O/G)	DD	812234	6070

Optipro SMDB 250- Cable Alley Unit (Double Door)

HSN Code: 8536

	Item Description	Type	Cat Ref.	Unit Price (₹)
	SMDB250 Cable Alley-6W DD	DD	812236	15048
	SMDB250 Cable Alley-8W DD	DD	812237	16256
	SMDB250 Cable Alley-12W DD	DD	812238	18324

Optipro SMDB 400/630- Cable Alley Unit (Double Door)

HSN Code: 8536

	Item Description	Type	Cat Ref.	Unit Price (₹)
	SMDB400/630 Cable Alley-4W DD	DD	812240	17788
	SMDB400/630 Cable Alley-6W DD	DD	812241	19604
	SMDB400/630 Cable Alley-8W DD	DD	812242	21190
	SMDB400/630 Cable Alley-12W DD	DD	812243	23236
	SMDB400/630 Cable Alley-8W DD	DD	812244	21190
	SMDB400/630 Cable Alley-12W DD	DD	812245	23236
	SMDB400/630 Cable Alley-12W DD	DD	812246	23236
	Metering Unit(for DD SMDB's with F1 O/G only)- with Ammeter,Voltmeter & Phase Indicators(3nos.)	DD	812248	20716
	Metering Unit (for DD SMDB's with F1 & F2 O/G) - with Ammeter,Voltmeter & Phase Indicators(3nos.)	DD	812249	22428
	Metering Unit(for DD SMDB's with F1 O/G only)- with Multifunction meter, Buzzer & Phase Indicators(3nos.)	DD	812250	25884
	Metering Unit (for DD SMDB's with F1 & F2 O/G) - with Multifunction meter, Buzzer & Phase Indicators(3nos.)	DD	812251	28024
	Corner Unit-DD	DD	812252	1912

SWITCH ON TO NEW RANGE OF EFFICIENT

SWITCH DISCONNECTOR AND TRANSFER SWITCHING EQUIPMENT



Modular 32, 40, 63A



SD **TSE**

Panel Mounted Frame 1- 100, 125, 160A Frame 2- 200, 250, 320A

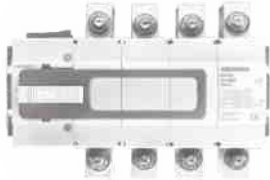

SD **TSE**



APPLICATIONS



Features

1. Quick and Easy Installation
2. Operational Voltage upto 550 V
3. High short time withstand upto 12.5kA for 1 sec
4. High Mechanical and Electrical endurance
5. Extra safety with add on accessories

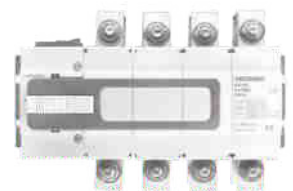

UNCOMPROMISED SAFETY WITH ADD ON ACCESSORIES



DIN FRAME

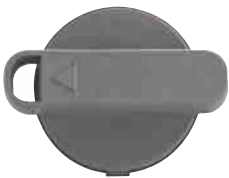

Direct Handle



Insulated Shorting Links



Auxillary Contact



Vari Depth Rotary Handle



POWER FRAME



Inter Source Barrier



Phase Barrier



Spreader



Auxillary Contact



Vari Depth Rotary Handle

— optinova™ —

Switch Disconnecter



Transfer Switching Equipment



				Din Frame			Power Frame-1				Power Frame-2			
Performance				IndoAsian OptiNova-SD										
General	Frame	lth	A	63			160				320			
	Rated currents			32	40	63	63	100	125	160	200	250	320	
	Poles	4			4				4					
Electrical	Rated insulation voltage	U _i	V	690			1000				1000			
	Rated Impulse Withstand Voltage	U _{imp}	kV	8			8				12			
	Rated frequency	Hz			50/60			50/60				50/60		
	Short time withstand current @ rated time(s)	t(s)	I _{cw} for 1s	1.5kA			4kA		5kA		10kA		12.5kA	

— optinova™ —

4P SWITCH DISCONNECTOR / TRANSFER SWITCHING EQUIPEMENT - DIN FRAME HSN Code: 8536

Rated Current	Switch Disconnecter		Transfer Switching Equipment TSE (On Load ChangeOver)	
	Cat Ref.	Unit Price (₹)	Cat Ref.	Unit Price (₹)
32A	824006	2100	824106	3850
40A	824007	2220	824107	4300
63A	824008	2630	824108	4800

— optinova™ —

4P SWITCH DISCONNECTOR / TRANSFER SWITCHING EQUIPEMENT - POWER FRAME HSN Code: 8536

Rated Current	Switch Disconnecter		Transfer Switching Equipment TSE (On Load ChangeOver)		Transfer Switching Equipment TSE (On Load ChangeOver) with Enclosure	
	Cat Ref.	Unit Price (₹)	Cat Ref.	Unit Price (₹)	Cat Ref.	Unit Price (₹)
63A	824082	3600	824182	5650	824192	8300
100A	824083	5070	824183	7100	824193	10800
125A	824084	5450	824184	10600	824194	15100
160A	824085	6840	824185	11700	824195	16600
200A	824086	8600	824186	14050	824196	19300
250A	824087	10800	824187	20100	824197	25700
320A	824088	11930	824188	21300	824198	27700

— optinova™ —

ACCESSORIES - DIN FRAME

HSN Code: 8538

Product	Cat Ref.	Unit Price (₹)
Shorting links 63A for TSE	824201	740
Auxiliary contact Simultaneous (1 NO + 1 NC)	824208	390
Handle Vary Depth KIT IP54	824209	1090
SD Direct Handle	824215	870
TSE Direct Handle	824217	870

— optinova™ —

ACCESSORIES - POWER FRAME

HSN Code: 8538

Product	Frame 1- 160A		Frame 2- 320A	
	Cat Ref.	Unit Price (₹)	Cat Ref.	Unit Price (₹)
Aux contact Simultaneous (4 NO + 4 NC)	824245	1090	824245	1090
Shorting Link for TSE	824249	2090	824241	3130
Phase Barriers	824251	170	824243	220
Inter source barrier for TSE	824252	220	824239	350
Spreader terminals (one side only)	824254	850	824238	1700
Handle Direct	824230	910	824230	910
Handle Vary Depth	824231	1300	824231	1300

HRC FUSE LINKS & BASES

BOLTED TYPE (BS) BREAKING CAPACITY ≥ 80kA 500 V AC 50 Hz.

HSN Code: 8536

Rating	Type	Cat Ref.	Tag Type	Unit Price (₹)	Unit/Carton
2, 4, 6, 8, 10, 16A	FGN	IEFGN***	Offset	88	20
20, 25, 32A	FGN	IEFGN***	Offset	98	20
2, 4, 6, 10, 16, 20, 25, 32A	FSA	IEFSA***	Offset	132	10
35, 40, 50, 63A	FSS	IEFSS***	Offset	148	10
50, 63, 80, 100, 125, 160A	FSDCP	IEDCP***	Offset	314	10
100, 125, 160, 200, 250A	FSFP	IESFP***	Offset	452	3
50, 63, 80, 100, 125A	FSDC	IESDC***	Central	314	10
100, 125, 160, 200, 250A	FSF	IEFSF***	Central	462	3
225, 250, 300, 315, 320A	FSK	IEFSK***	Central	668	3
355, 400A	FMF	IEFMF***	Central	1290	3
355, 400, 450, 500, 560, 600, 630A	FTS	IEFTS***	Central	1488	1
355, 400, 450, 500, 560A	FTM	IEFTM***	2 Central	1920	1
600, 630A	FTM	IEFTM***	2 Central	2640	1

DIN TYPE BREAKING CAPACITY ≥ 80kA 500 V AC 50 Hz.

HSN Code: 8536

Rating Amps	Type	Cat Ref.	Unit Price (₹)	Unit/Carton
2, 4, 6, 10, 16, 20, 25, 32, 50, 63A	Size 000	IWS00***	394	6
2, 4, 6, 10, 16, 20, 25, 32, 36, 40, 50, 63A	Size 00	IW000***	418	6
80, 100A		IW000***	436	6
125, 160A		IW000***	464	6
32, 36, 50, 63, 80, 100, 125, 160, 200A	Size 01	IW001***	766	3
250A		IW001***	872	3
100, 125, 160, 200, 250, 315A	Size 02	IW002***	1124	3
400A		IW002***	1216	3
315, 355, 400, 425A	Size 03	IW003***	1544	3
500, 630A		IW003***	1796	3

* Note HRC fuses with SC breaking capacity 120kA are available on request.

CYLINDRICAL TYPE (IFRH) BREAKING CAPACITY > 80kA 415 V AC.

HSN Code: 8536

Rating	Cat Ref.	Unit Price (₹)
2 to 25A	IFRHO***	166
32 to 40A	IFRHO***	174
50A	IFRH0050	322
63A	IFRH0063	332
Fuse Holder Fr type (2 to 63A)	IFR00***	310

FUSE FITTINGS FOR BOLTED (BS) TYPE

HSN Code: 8536

Rating	Front Connection	Unit Price (₹)	Back Busbar Connection	Unit Price (₹)	Unit/Carton
20A	BFFC 0020	188	BFBC 0020	202	10
32A	BFFC 0032	330	BFBC 0032	342	10
63A	BFFC 0063	474	BFBC 0063	500	5
100A	BFFC 0100	1220	BFBC 0100	1156	3
20A (Stud Type)			BFFCS 020	272	1

FUSE BASES FOR DIN TYPE HRC FUSE LINKS

HSN Code: 8536

Rating Amps	Suitable for	Cat Ref.	Unit Price (₹)	Unit/Carton
6-160A	Size - 00	IWFBO***	538	6
32-250A	Size - 1	IWFB1***	1026	2
100-400A	Size - 2	IWFB2***	1532	2
315-630A	Size - 3	IWFB3***	1944	2

SWITCH DISCONNECTOR FUSES

HSN Code: 8536

Rated Current	Type	IN OPEN EXECUTION*		IN SHEET STEEL ENCLOSURE		Recommended HRC Fuse Indo Asian Make
		Cat Ref.	Unit Price (₹)	Cat Ref.	Unit Price (₹)	
32A BS	TPN	INO1A032	2030	INS1A032	4142	FSA
63A BS	TPN	INO1A063	2808	INS1A063	5276	FSS
100A BS	TPN	INO1A100	6174	INS1A100	8636	FSDCP
125A BS	TPN	INO1A125	6926	INS1A125	10350	FSDCP
160A BS	TPN	INO1A160	8384	INS1A160	11556	FSDCP
200A BS	TPN	INO1A200	10432	INS1A200	13444	FSF
250A BS	TPN	INO1A250	11776	INS1A250	15542	FSF
315A BS	TPN	INO1A315	15090	INS1A315	19406	FSK
400A BS	TPN	INO1A400	18730	INS1A400	23164	FMF
32A BS	TPSN	INO1B032	2580	INS1B032	4368	FSA
63A BS	TPSN	INO1B063	3276	INS1B063	5168	FSS
100A BS	TPSN	INO1B100	7590	INS1B100	9670	FSDCP
125A BS	TPSN	INO1B125	8312	INS1B125	10350	FSDCP
160A BS	TPSN	INO1B160	10396	INS1B160	13376	FSDCP
200A BS	TPSN	INO1B200	11842	INS1B200	14800	FSF
250A BS	TPSN	INO1B250	12910	INS1B250	16618	FSF
315A BS	TPSN	INO1B315	18268	INS1B315	23212	FSK
400A BS	TPSN	INO1B400	21612	INS1B400	24144	FMF

* Price Does Not Include HRC Fuse

HSN Code: 8536

Rated Current	Type	IN OPEN EXECUTION*		IN SHEET STEEL ENCLOSURE		Recommended HRC Fuse Indo Asian Make
		Cat Ref.	Unit Price (₹)	Cat Ref.	Unit Price (₹)	
32A DIN	TPN	IN1OA032	2132	IN1SA032	3942	Size 000
63A DIN	TPN	IN1OA063	2958	IN1SA063	5010	Size 000
100A DIN	TPN	IN1OA100	6328	IN1SA100	8540	Size 00
125A DIN	TPN	IN1OA125	7230	IN1SA125	10320	Size 00
160A DIN	TPN	IN1OA160	8700	IN1SA160	11338	Size 00
200A DIN	TPN	IN1OA200	10862	IN1SA200	12904	Size 01
250A DIN	TPN	IN1OA250	12168	IN1SA250	15534	Size 01
315A DIN	TPN	IN1OA315	15632	IN1SA315	19336	Size 02
400A DIN	TPN	IN1OA400	19270	IN1SA400	22920	Size 02
630A DIN	TPN	IN1OA630	30352	IN1SA630	32688	Size 03
800A DIN	TPN	IN1OA800	37008	IN1SA800	46272	Size 03
32A DIN	TPSN	IN1OB032	3022	IN1SB032	4056	Size 000
63A DIN	TPSN	IN1OB063	3484	IN1SB063	4380	Size 000
100A DIN	TPSN	IN1OB100	7806	IN1SB100	8736	Size 00
125A DIN	TPSN	IN1OB125	8650	IN1SB125	9404	Size 00
160A DIN	TPSN	IN1OB160	10136	IN1SB160	12574	Size 00
200A DIN	TPSN	IN1OB200	11780	IN1SB200	13262	Size 01
250A DIN	TPSN	IN1OB250	13490	IN1SB250	15194	Size 01
315A DIN	TPSN	IN1OB315	18056	IN1SB315	20676	Size 02
400A DIN	TPSN	IN1OB400	20984	IN1SB400	25816	Size 02
630A DIN	TPSN	IN1OB630	33688	IN1SB630	35312	Size 03
800A DIN	TPSN	IN1OB800	38952	IN1SB800	50898	Size 03

* Price Does Not Include HRC Fuse

SWITCH DISCONNECTOR 4 POLE

HSN Code: 8536

Rated Current	IN OPEN EXECUTION*		IN SHEET STEEL ENCLOSURE	
	Cat Ref.	Unit Price (₹)	Cat Ref.	Unit Price (₹)
32A	IN1SD032	POR	IN1ED032	POR
63A	IN1SD063	POR	IN1ED063	POR
100A	IN1SD100	POR	IN1ED100	POR
125A	IN1SD125	POR	IN1ED125	POR
160A	IN1SD160	POR	IN1ED160	POR
200A	IN1SD200	POR	IN2ED200	POR
250A	IN1SD250	POR	IN2ED250	POR
315A	IN1SD315	POR	IN3ED315	POR
400A	IN1SD400	15356	IN3ED400	24290
630A	IN1SD630	21312	IN4ED630	35436
800A	IN1SD800	25382	IN4ED800	41046

** POR - Price on Request.

*Prices of 3 Pole SD is available on Request.

**Ambidex CHANGEOVER SWITCHES
ON-LOAD CHANGEOVER SWITCHES 4 POLE**

HSN Code: 8536

Rated Current	IN OPEN EXECUTION		IN SHEET STEEL ENCLOSURE	
	Cat Ref.	Unit Price (₹)	Cat Ref.	Unit Price (₹)
63A	ITAE0063	POR	ITAS0063	POR
100A	ITAE0100	POR	ITAS0100	POR
125A	ICAE0125	POR	ICAS0125	POR
160A	ICAE0160	POR	ICAS0160	POR
200A	ICAE0200	POR	ICAS0200	POR
250A	ICAE0250	POR	ICAS0250	POR
320A	ICAE0320	POR	ICAS0320	POR
400A	ICAE0400	33502	ICAS0400	52628
630A	ICAE0630	39468	ICAS0630	56396
800A	ITAE0800	55042	ITAS0800	82620
1000A	ITAE1000	99570	ITAS1000	138470
1250A	ITAE1250	133630	ITAS1250	191166
1600A	ITAE1600	153442	ITAS1600	253652
2000A	ITAE2000	224384	ITAS2000	311016
2500A	ITAE2500	308704	ITAS2500	412544
3150A	ITAE3150	315734	ITAS3150	535548

** POR - Price on Request.

HSN Code: 8536

ACCESSORIES FOR AMBIDEX CHANGEOVER SWITCHES	Cat Ref.	Unit Price (₹)
Auxiliary Switch 200A-630A (1NO + 1NC)	ICA00AUX	230
Spreader Links for Frame00 - 1 set (4 links)	ICA00SPL	360

ON-LOAD SWITCH FUSE CHANGEOVER

HSN Code: 8536

Rated Current	IN OPEN EXECUTION		IN SHEET STEEL ENCLOSURE		Recommended HRC Fuse Indo Asian Make
	Cat Ref.	Unit Price (₹)	Cat Ref.	Unit Price (₹)	
125A	ITBE0125	15700	ITBS0125	23992	FSDCP
200A	ITBE0200	28684	ITBS0200	42586	FSF
250A	ITBE0250	28954	ITBS0250	42982	FSK
320A	ITBE0320	29892	ITBS0320	44380	FSK
400A	ITBE0400	42876	ITBS0400	63656	FTS
630A	ITBE0630	50040	ITBS0630	74296	FTS

Price does not include HRC Fuses.

ON-LOAD BY-PASS SWITCHES

HSN Code: 8536

Rated Current	IN OPEN EXECUTION		IN SHEET STEEL ENCLOSURE	
	Cat Ref.	Unit Price (₹)	Cat Ref.	Unit Price (₹)
125A	ITCE0125	22012	ITCS0125	29720
200A	ITCE0200	28028	ITCS0200	37838
250A	ITCE0250	40716	ITCS0250	54966
320A	ITCE0320	42278	ITCS0320	57076
400A	ITCE0400	63416	ITCS0400	85614
630A	ITCE0630	72046	ITCS0630	97268

REWIRABLE SWITCH FUSE UNIT

HSN Code: 8537

 <ul style="list-style-type: none"> • Single Pole & Neutral/Double Pole 240/415 VAC 50 Hz • Conforms to IS/IEC 13947-3 	Rating	Type	Cat Ref.	Rated Voltage	Unit Price* (₹)
	16A	SPN	RCSPN016	240 V	848
	32A	SPN	RCSPN032	240 V	2042
	16A	DP	RCDP0016	240 V	894
	32A	DP	RCDP0032	240 V	2098
	32A	DP	#DDP0032	415 V	2884
	63A	DP	#DDP0063	415 V	5410

For Rewirable type carrier, prefix R, for HRC type carrier, prefix H.
* These prices are without wire & HRC.

COMBINATION FUSE SWITCH

HSN Code: 8536

 <ul style="list-style-type: none"> • Double Break in Sheet steel enclosure • Conforms to IS/IEC 13947-3 • Rated Voltage - 415V AC 50 Hz • Type - TPN 	Rating	HRC Fuse Type	Cat Ref.	Unit Price* (₹)
	63A	FSS	DDTPN063	10248
	100A	FSDCP	DDTPN100	13762
	200A	FSF	DDTPN200	20484
	300A	FSK	DDTPN300	25842
	400A	FTS	DDTPN400	37486

* These prices are without HRC.

**TRIPLE POLE NEUTRAL HRC TYPE
REWIRABLE SWITCH FUSE UNIT**

HSN Code: 8537 H
HSN Code: 8536 R

 <ul style="list-style-type: none"> • Rated Voltage - 415V-AC 50Hz • Type - TPN 	Rating	HRC Fuse Type	Cat Ref.	Unit Price* (₹)
	16A	FSA	#DTPN016	2474
	32A	FSA	#DTPN032	3328
	63A	FSS	#DTPN063	7082
	100A	FSDCP	#DTPN100	12918

For Rewirable type carrier, prefix R, for HRC type carrier, prefix H.
* These prices are without wire & HRC.

OFF LOAD CHANGEOVER SWITCH

HSN Code: 8536

 <ul style="list-style-type: none"> • With enclosure • Rated Voltage - 415V-AC 50Hz • Type - FP 	Rating	Cat Ref.	Unit Price (₹)
	32A (DP)	OFFP0032	1994
	16A	OFFP0016	3194
	32A	OFFP0032	3334
	63A	OFFP0063	6774
	100A	OFFP0100	13240
	125A	OFFP0125	18612
	200A	OFFP0200	20094
	250A	OFFP0250	25598
	315A	OFFP0315	26426
	400A	OFFP0400	30828

Prices for spares of Rewirable Switch Fuse Unit like Action Bar, Base Plate, End Shield, Bakelite Contact Shrouds are available on request.



Shynora

SWITCH & SOCKET

Add a touch of shine to your life.



Shynora

WHITE MECHANISMS

SWITCHES: • Polycarbonate Material* • LED Based Indicator • Shrouded Terminal • ISI Marked

SWITCHES 6A 230 V AC

HSN Code: 8536

	Cat. Nos.	Description	Module	Unit Price (₹)	Pack
	810600	6A 1 Way Switch	1	43	1/20/200
	810610	6A 2 Way Switch	1	86	1/20/200
	810602	6A 1 Way Switch with Indicator	1	88	1/20/200
	810604	6A 1 Way Switch with "Light" Marking	1	92	1/20/200
	810605	6A 1Way Switch with "Fan" Marking	1	92	1/20/200

SWITCHES 16A 230 V AC

HSN Code: 8536

	Cat. Nos.	Description	Module	Unit Price (₹)	Pack
	810601	16A 1 Way Switch	1	106	1/20/200
	810611	16A 2 Way Switch	1	142	1/10/100
	810603	16A 1 Way Switch with Indicator	1	126	1/20/200

SWITCHES 20A 230 V AC

HSN Code: 8536

	Cat. Nos.	Description	Module	Unit Price (₹)	Pack
	810606	20A 1 Way Switch	1	148	1/20/200
	810607	20A 1 Way Switch with Indicator	1	164	1/20/200
	810609	20A SP 1 Way Switch	2	202	1/10/100
	810612	20A DP Switch with Indicator	2	182	1/10/100

SWITCHES 25A 230 V AC

HSN Code: 8536

	Cat. Nos.	Description	Module	Unit Price (₹)	Pack
	810608	25A 1 Way Switch with Indicator	1	190	1/20/200

SWITCHES 32A 230 V AC

HSN Code: 8536

	Cat. Nos.	Description	Module	Unit Price (₹)	Pack
	810613	32A DP Switch with Indicator	2	252	1/10/100

BELL PUSH BUTTON 6A 230 V AC

HSN Code: 8536

	Cat. Nos.	Description	Module	Unit Price (₹)	Pack
	810615	6A Bell Push Switch	1	92	1/20/200
	810616	6A Bell Push Switch with Indicator	1	96	1/20/200
	810617	6A Bell Push Switch with Indicator	2	144	1/10/100

ACCESSORIES FOR SWITCHES

HSN Code: 8536

	Cat. Nos.	Description	Module	Unit Price (₹)	Pack
	810650	LED Indicator for Switches (Red)	-	34	1/5/25

Shynora

SOCKET 240 V AC • Child Safety Shutter • Shrouded Terminals • Smooth Plug removal & insertion

HSN Code: 8536

	Cat. Nos.	Description	Module	Unit Price (₹)	Pack
	810620	6A 3 Pin Round Socket with Shutter (ISI mark)	2	108	1/20/200
	810621	6A/16A 3 Pin Socket with Shutter (ISI Mark)	2	206	1/10/100
	810624	25A 3 Pin Socket with Shutter	2	216	1/10/50

DIMMERS AND FAN REGULATORS • Laser Marking

HSN Code: 8538 & 8414

	Cat. Nos.	Description	Module	Unit Price (₹)	Pack
	810641	Light Dimmer -400W	1	374	1/10/100
	810642	Light Dimmer -500W	2	486	1/10/100
	810638	Fan 4 Step Regulator 100W (ISI mark)	1	354	1/10/100
	810639	Fan Step Regulator 360 deg 100W (ISI mark)	2	464	1/10/100
	810640	Fan 8 step Regulator 100W	2	618	1/10/100

SKIRTING LIGHT

HSN Code: 9405

	Cat. Nos.	Description	Module	Unit Price (₹)	Pack
	810649	Skirting Light	2	362	1/5/50

INDICATOR

HSN Code: 8536

	Cat. Nos.	Description	Module	Unit Price (₹)	Pack
	810645	Flat Indicator Red	1	108	1/20/200

BELL CALL INDICATOR

HSN Code: 8536

	Cat. Nos.	Description	Module	Unit Price (₹)	Pack
	810644	Bell Call Indicator	1	640	1/20/100

BUZZER

HSN Code: 8536

	Cat. Nos.	Description	Module	Unit Price (₹)	Pack
	810637	Buzzer -230V	1	262	1/20/100

**HOSPITALITY FUNCTION
HOTEL KEYCARD SWITCH**

HSN Code: 8538

	Cat. Nos.	Description	Module	Unit Price (₹)	Pack
	810614	32A DP Keytag Switch (Mechanical)	2	422	1/10
	810646	Key Card SW 16A + Key Fob	2	2,306	1/1/10

Shynora

HOSPITALITY FUNCTION HOTEL "DND AND MMR"

HSN Code: 8538

	Cat. Nos.	Description	Module	Unit Price (₹)	Pack
	810647	DND Internal Unit	2	308	1/10/100
	810648	DND External Unit	2	346	1/10/100

SHAVER SOCKET

HSN Code: 8538

	Cat. Nos.	Description	Module	Unit Price (₹)	Pack
	810666	Shaver Socket	4	3,840	1/5/20

SOCKETS AND CONNECTORS

TV SOCKETS

HSN Code: 8536

	Cat. Nos.	Description	Module	Unit Price (₹)	Pack
	810633	TV Socket	1	100	1/20/200

DATA & VOICE

HSN Code: 8536

	Cat. Nos.	Description	Module	Unit Price (₹)	Pack
	810631	Telephone Socket - RJ11 with Shutter	1	98	1/20/200
	810632	Computer Socket- RJ45 Cat 6 with Shutter	1	628	1/20/200

SOUND - ELECTRONIC BELL

HSN Code: 8536

	Cat. Nos.	Description	Module	Unit Price (₹)	Pack
	810643	Electronic Bell	2	252	1/10/100

PROTECTORS AND ACCESSORIES

MOTOR STARTER

HSN Code: 8536

	Cat. Nos.	Description	Module	Unit Price (₹)	Pack
	810664	16A Motor Starter	2	504	10/50
	810665	25A Motor Starter	2	504	10/50

MODULAR MCB (IS : 608981:2002) • ISI Mark

HSN Code: 8536

	Cat. Nos.	Description	Module	Unit Price (₹)	Pack
	810654	6A Mini MCB SP C Curve	1	380	1/1/100
	810655	10A Mini MCB SP C Curve	1	380	1/1/100
	810656	16A Mini MCB SP C Curve	1	380	1/1/100
	810657	20A Mini MCB SP C Curve	1	380	1/1/100
	810658	25A Mini MCB SP C Curve	1	380	1/1/100
	810659	32A Mini MCB SP C Curve	1	380	1/1/100
	810660	16A Mini MCB DP C Curve	2	678	1/1/100
	810661	20A Mini MCB DP C Curve	2	678	1/1/100
	810662	25A Mini MCB DP C Curve	2	678	1/1/100
	810663	32A Mini MCB DP C Curve	2	678	1/1/100

Shynora

PROTECTORS AND ACCESSORIES

POWER UNIT • Prewired, Suitable for 2 Ton AC / 3.5 kw Geyser*

HSN Code: 8536

	Cat. Nos.	Description	Module	Unit Price (₹)	Pack
	810618	Power Unit 16A Socket (AC & Geyser)*	4	374	1/5
	810625	Power Unit with 20A MCB & 16A Plug	3	908	1/10
	810626	Power Unit with 25A MCB & 16A Plug	3	974	1/10

ELECTRONIC FUNCTION

USB CHARGERS (IS13252 (PART 1) / IEC 60950-1) • CRS Certified

HSN Code: 8536

	Cat. Nos.	Description	Module	Unit Price (₹)	Pack
	810652	USB Charger 1500mA Type A	1	882	1/10/100
	810651	Double USB Charger 3000mA Type A	2	1,406	1/10/100

COMBI (SOCKET + USB) • CRS Certified

HSN Code: 8536

	Cat. Nos.	Description	Module	Unit Price (₹)	Pack
	810671	Combi Twin USB 3100mA Type A with Euro US Socket	2	1,900	1/10/100
	810672	Combi Twin USB 3100mA Type A & Type C with Euro US Socket	2	2,544	1/10/100

ACCESSORIES

HSN Code: 8538

	Cat. Nos.	Description	Module	Unit Price (₹)	Pack
	810667	1 Module Blank Plate	1	26	1/40/400
	810668	Cable Outlet	1	78	1/20/100

Shynora

COOL GREY MECHANISMS

SWITCHES: • Polycarbonate Material* • LED Based Indicator • Shrouded Terminal • ISI Marked

SWITCHES 6A 230 V AC

HSN Code: 8536

	Cat. Nos.	Description	Module	Unit Price (₹)	Pack
	810700	6A 1 Way Switch	1	51	1/20/200
	810710	6A 2 Way Switch	1	100	1/20/200
	810702	6A 1 Way Switch with Indicator	1	102	1/20/200
	810704	6A 1 Way Switch with "Light" Marking	1	108	1/20/200
	810705	6A 1 Way Switch with "Fan" Marking	1	108	1/20/200

SWITCHES 16A 230 V AC

HSN Code: 8536

	Cat. Nos.	Description	Module	Unit Price (₹)	Pack
	810701	16A 1 Way Switch	1	126	1/20/200
	810703	16A 1 Way Switch with Indicator	1	136	1/20/200

SWITCHES 20A 230 V AC

HSN Code: 8536

	Cat. Nos.	Description	Module	Unit Price (₹)	Pack
	810706	20A 1 Way Switch	1	174	1/20/200
	810707	20A 1 Way Switch with Indicator	1	188	1/20/200
	810709	20A SP 1 Way Switch	2	236	1/10/100
	810712	20A DP Switch with Indicator	2	210	1/10/100

Shynora

SWITCHES 25A 230 V AC

HSN Code: 8536

	Cat. Nos.	Description	Module	Unit Price (₹)	Pack
	810708	25A 1 Way Switch with Indicator	1	208	1/20/200

SWITCHES 32A 230 V AC

HSN Code: 8536

	Cat. Nos.	Description	Module	Unit Price (₹)	Pack
	810713	32A DP Switch with Indicator	2	290	1/10/100

BELL PUSH BUTTON 6A 230 V AC

HSN Code: 8536

	Cat. Nos.	Description	Module	Unit Price (₹)	Pack
	810715	6A Bell Push Switch	1	106	1/20/200
	810716	6A Bell Push Switch with Indicator	1	112	1/20/200
	810717	6A Bell Push Switch with Indicator	2	168	1/10/100

SOCKET 240 V AC • Child Safety Shutter • Shrouded Terminals • Smooth Plug removal & insertion

HSN Code: 8536

	Cat. Nos.	Description	Module	Unit Price (₹)	Pack
	810720	6A 3 Pin Round Socket with Shutter (ISI mark)	2	130	1/20/200
	810721	6A/16A 3 Pin Socket with Shutter (ISI Mark)	2	244	1/10/100
	810724	25A 3 Pin Socket with Shutter	2	256	1/10/50

DIMMERS AND FAN REGULATORS • Laser Marking

HSN Code: 8538 & 8414

	Cat. Nos.	Description	Module	Unit Price (₹)	Pack
	810741	Light Dimmer -400W	1	432	1/10/100
	810742	Light Dimmer -500W	2	568	1/10/100
	810738	Fan 4 Step Regulator 100W (ISI mark)	1	412	1/10/100
	810739	Fan Step Regulator 360 deg 100W (ISI mark)	2	542	1/10/100
	810740	Fan 8 step Regulator 100W	2	774	1/10/100

SKIRTING LIGHT

HSN Code: 9405

	Cat. Nos.	Description	Module	Unit Price (₹)	Pack
	810749	Skirting Light	2	394	1/5/50

INDICATOR

HSN Code: 8536

	Cat. Nos.	Description	Module	Unit Price (₹)	Pack
	810745	Flat Indicator Red	1	116	1/20/200

BUZZER

HSN Code: 8536

	Cat. Nos.	Description	Module	Unit Price (₹)	Pack
	810737	Buzzer -230V	1	304	1/20/100

Shynora

HOSPITALITY FUNCTION HOTEL KEYCARD SWITCH

HSN Code: 8538

	Cat. Nos.	Description	Module	Unit Price (₹)	Pack
	810714	32A DP Keytag Switch (Mechanical)	2	490	1/10
	810746	Key Card SW 16A + Key Fob	2	2,894	1/1/10

HOTEL "DND AND MMR"

HSN Code: 8538

	Cat. Nos.	Description	Module	Unit Price (₹)	Pack
	810747	DND Internal Unit	2	386	1/10/100
	810748	DND External Unit	2	432	1/10/100

SHAVER SOCKET

HSN Code: 8538

	Cat. Nos.	Description	Module	Unit Price (₹)	Pack
	810766	Shaver Socket	4	4820	1/5/20

SOCKETS AND CONNECTORS

TV SOCKETS

HSN Code: 8536

	Cat. Nos.	Description	Module	Unit Price (₹)	Pack
	810733	TV socket	1	118	1/20/200

DATA & VOICE

HSN Code: 8536

	Cat. Nos.	Description	Module	Unit Price (₹)	Pack
	810731	Telephone Socket - RJ11 with Shutter	1	116	1/20/200
	810732	Computer Socket- RJ45 Cat 6 with Shutter	1	730	1/20/200

PROTECTORS AND ACCESSORIES

MOTOR STARTER

HSN Code: 8536

	Cat. Nos.	Description	Module	Unit Price (₹)	Pack
	810764	16A Motor Starter	2	590	10/50
	810765	25A Motor Starter	2	590	10/50

Shynora

PROTECTORS AND ACCESSORIES

MODULAR MCB (IS : 608981:2002) • ISI Mark

HSN Code: 8536

	Cat. Nos.	Description	Module	Unit Price (₹)	Pack
	810754	6A Mini MCB SP C Curve	1	440	1/1/100
	810755	10A Mini MCB SP C Curve	1	440	1/1/100
	810756	16A Mini MCB SP C Curve	1	440	1/1/100
	810757	20A Mini MCB SP C Curve	1	440	1/1/100
	810758	25A Mini MCB SP C Curve	1	440	1/1/100
	810759	32A Mini MCB SP C Curve	1	440	1/1/100

POWER UNIT • Prewired, Suitable for 2 Ton AC / 3.5 kw Geyser*

HSN Code: 8536

	Cat. Nos.	Description	Module	Unit Price (₹)	Pack
	810718	Power Unit 16A Socket (AC & Geyser)*	4	432	1/5
	810725	Power Unit with 20A MCB & 16A Plug	3	1056	1/10
	810726	Power Unit with 25A MCB & 16A Plug	3	1134	1/10

ELECTRONIC FUNCTION

USB CHARGERS (IS13252 (PART 1) / IEC 60950-1) • CRS Certified

HSN Code: 8536

	Cat. Nos.	Description	Module	Unit Price (₹)	Pack
	810752	USB Charger 1500mA Type A	1	1104	1/10/100
	810751	Double USB Charger 3000mA Type A	2	1,632	1/10/100

COMBI (SOCKET + USB) • CRS Certified

HSN Code: 8536

	Cat. Nos.	Description	Module	Unit Price (₹)	Pack
	810771	Combi Twin USB 3100mA Type A with Euro US Socket	2	2190	1/10/100
	810772	Combi Twin USB 3100mA Type A & Type C with Euro US Socket	2	2,932	1/10/100

ACCESSORIES

HSN Code: 8538



	Cat. Nos.	Description	Module	Unit Price (₹)	Pack
	810767	1 Module Blank Plate	1	30	1/40/400
	810768	Cable Outlet	1	84	1/20/100

PLATE & FRAME • Strong Dimensional Stability

WHITE MODULAR PLATE WITH SUPPORT FRAME

HSN Code: 8538

	Cat. Nos.	Description	Module	Unit Price (₹)	Pack
	810800	White Plate + Frame, 1 module	1	78	1/10/100
	810801	White Plate + Frame, 2 module	2	78	1/10/100
	810802	White Plate + Frame, 3 module	3	116	1/10/100
	810803	White Plate + Frame, 4 module	4	124	1/10/100
	810804	White Plate + Frame, 6 module	6	170	1/5/50
	810805	White Plate + Frame, 8 module	8	218	1/5/50
	810806	White Plate + Frame, 4X2 module	8	218	1/5/25
	810807	White Plate + Frame, 9 module	9	246	1/5/50
	810808	White Plate + Frame, 12 module	12	288	1/5/25
	810809	White Plate + Frame, 16 module	16	326	1/5/25
	810810	White Plate + Frame, 18 module	18	390	1/5/25

Shynora

COOL GREY MODULAR PLATE WITH SUPPORT FRAME

HSN Code: 8538

	Cat. Nos.	Description	Module	Unit Price (₹)	Pack
	810811	Cool Grey Plate + Frame, 1 module	1	94	1/10/100
	810812	Cool Grey Plate + Frame, 2 module	2	94	1/10/100
	810813	Cool Grey Plate + Frame, 3 module	3	140	1/10/100
	810814	Cool Grey Plate + Frame, 4 module	4	152	1/10/100
	810815	Cool Grey Plate + Frame, 6 module	6	212	1/5/50
	810816	Cool Grey Plate + Frame, 8 module	8	242	1/5/50
	810817	Cool Grey Plate + Frame, 4X2 module	8	248	1/5/25
	810818	Cool Grey Plate + Frame, 9 module	9	300	1/5/50
	810819	Cool Grey Plate + Frame, 12 module	12	350	1/5/25
	810820	Cool Grey Plate + Frame, 16 module	16	396	1/5/25
	810821	Cool Grey Plate + Frame, 18 module	18	476	1/5/25

CHROME MODULAR PLATE WITH SUPPORT FRAME

HSN Code: 8538

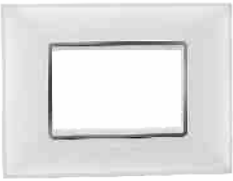
	Cat. Nos.	Description	Module	Unit Price (₹)	Pack
	810833	Chrome Plate + Frame, 1 module	1	90	1/10/100
	810834	Chrome Plate + Frame, 2 module	2	90	1/10/100
	810835	Chrome Plate + Frame, 3 module	3	122	1/10/100
	810836	Chrome Plate + Frame, 4 module	4	142	1/10/100
	810837	Chrome Plate + Frame, 6 module	6	196	1/5/50
	810838	Chrome Plate + Frame, 8 module	8	228	1/5/50
	810839	Chrome Plate + Frame, 4X2 module	8	234	1/5/25
	810840	Chrome Plate + Frame, 9 module	9	282	1/5/50
	810841	Chrome Plate + Frame, 12 module	12	328	1/5/25
	810842	Chrome Plate + Frame, 16 module	16	374	1/5/25
	810843	Chrome Plate + Frame, 18 module	18	448	1/5/25

PINK MODULAR PLATE WITH SUPPORT FRAME

HSN Code: 8538

	Cat. Nos.	Description	Module	Unit Price (₹)	Pack
	810844	Pink Plate + Frame, 1 module	1	106	1/10/100
	810845	Pink Plate + Frame, 2 module	2	106	1/10/100
	810846	Pink Plate + Frame, 3 module	3	146	1/10/100
	810847	Pink Plate + Frame, 4 module	4	168	1/10/100
	810848	Pink Plate + Frame, 6 module	6	238	1/5/50
	810849	Pink Plate + Frame, 8 module	8	294	1/5/50
	810850	Pink Plate + Frame, 4X2 module	8	294	1/5/25
	810851	Pink Plate + Frame, 9 module	9	344	1/5/50
	810852	Pink Plate + Frame, 12 module	12	398	1/5/25
	810853	Pink Plate + Frame, 16 module	16	498	1/5/25
	810854	Pink Plate + Frame, 18 module	18	540	1/5/25

Shynora

MILAN GOLD MODULAR PLATE WITH SUPPORT FRAME

HSN Code: 8538

	Cat. Nos.	Description	Module	Unit Price (₹)	Pack
	810855	Milan Gold Plate + Frame, 1 module	1	106	1/10/100
	810856	Milan Gold Plate + Frame, 2 module	2	106	1/10/100
	810857	Milan Gold Plate + Frame, 3 module	3	146	1/10/100
	810858	Milan Gold Plate + Frame, 4 module	4	168	1/10/100
	810859	Milan Gold Plate + Frame, 6 module	6	238	1/5/50
	810860	Milan Gold Plate + Frame, 8 module	8	294	1/5/50
	810861	Milan Gold Plate + Frame, 4X2 module	8	294	1/5/25
	810862	Milan Gold Plate + Frame, 9 module	9	344	1/5/50
	810863	Milan Gold Plate + Frame, 12 module	12	398	1/5/25
	810864	Milan Gold Plate + Frame, 16 module	16	498	1/5/25
	810865	Milan Gold Plate + Frame, 18 module	18	540	1/5/25

METAL FLUSH BOX • Made of G.I. Sheet • Earth Terminal for Safety • Provision for Knockouts Available

HSN Code: 8538

	Cat. Nos.	Description	Module	Unit Price (₹)	Pack
	800172	Metal Flush Box, 1/2 Module	1/2	64	1/0/40
	800173	Metal Flush Box, 3 Module	3	84	1/0/40
	800174	Metal Flush Box, 4 Module	4	98	1/0/40
	800176	Metal Flush Box, 6 Module	6	150	1/0/20
	800177	Metal Flush Box, 8 Module (vertical)	8	194	1/0/20
	800178	Metal Flush Box, 8 Module	8	194	1/0/20
	810867	Metal Flush Box, 9 Module	9	232	1/0/20
	800175	Metal Flush Box, 12 Module	12	256	1/0/10
	800179	Metal Flush Box, 16 Module	16	292	1/0/10
	800180	Metal Flush Box, 18 Module	18	318	1/0/10

WHITE SURFACE BOX • Flame Retardant Material • Edge to Edge Fitting with Plate

HSN Code: 8538

	Cat. Nos.	Description	Module	Unit Price (₹)	Pack
	800182	Plastic Surface Box, 1/2 Module	1/2	66	1/0/50
	800183	Plastic Surface Box, 3 Module	3	84	1/0/35
	800184	Plastic Surface Box, 4 Module	4	96	1/0/25
	800186	Plastic Surface Box, 6 Module	6	148	1/0/10
	800187	Plastic Surface Box, 8 Module (vertical)	8	200	1/0/15
	810866	Plastic Surface Box, 8 Module	8	214	1/10/10
	800185	Plastic Surface Box, 12 Module	12	252	1/0/10
	800189	Plastic Surface Box, 16 Module	16	294	1/0/10
	800190	Metal Surface Box, 18 Module	18	328	1/0/10

Cover Plates - Shynora

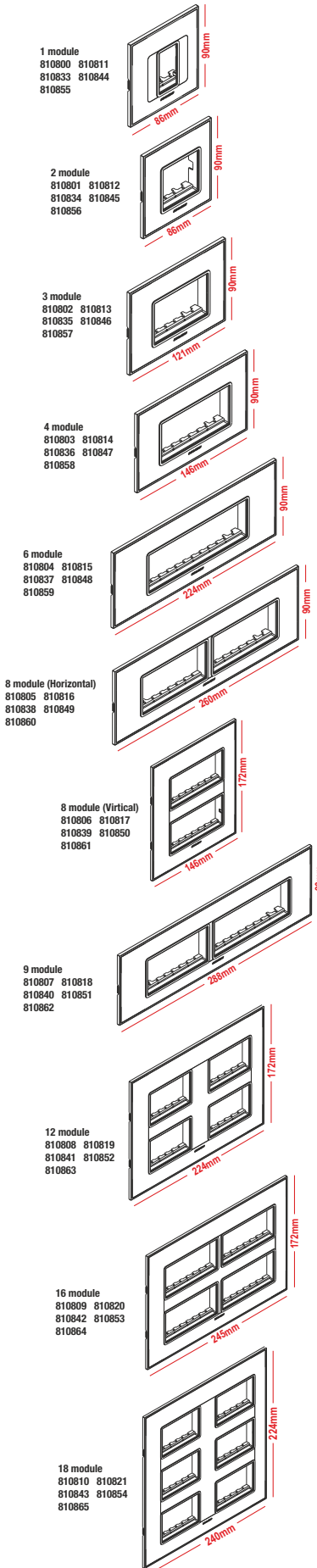

Flush Boxes-Metal

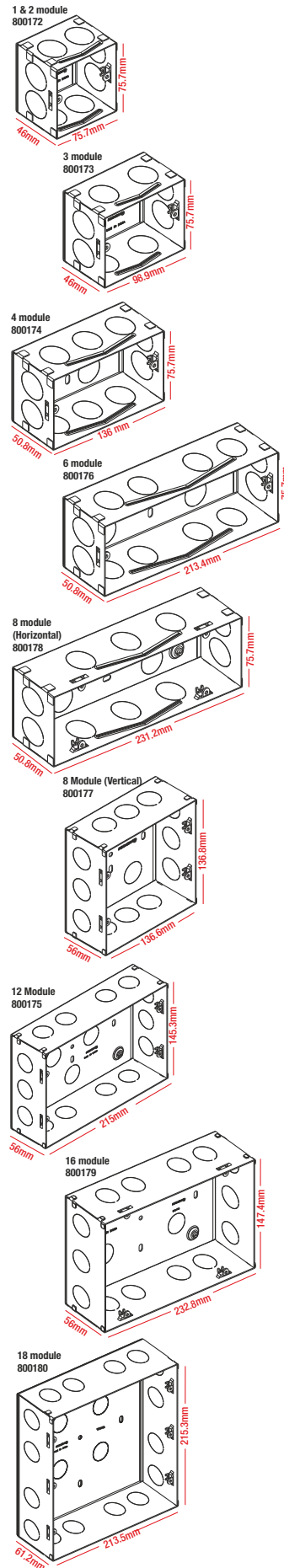

Surface Boxes- Plastic

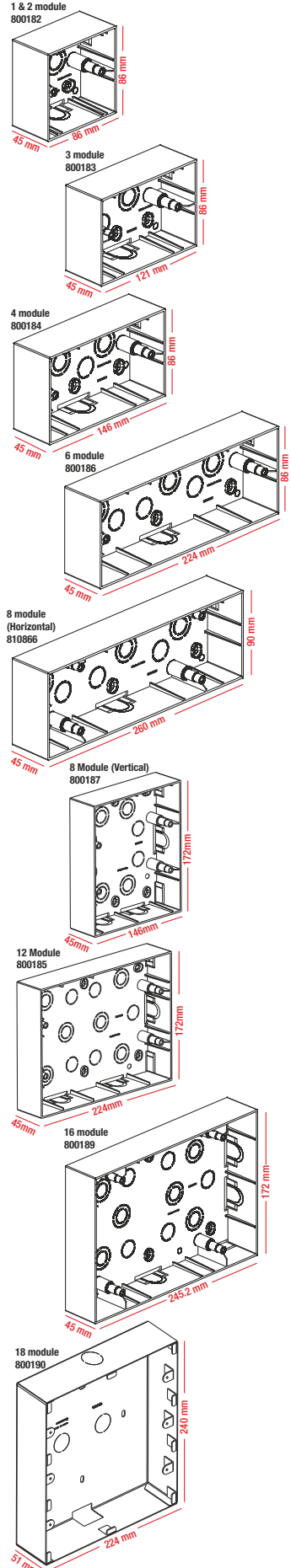

GlintTM

Welcome Change

SWITCH & SOCKET

INDOASIAN[®]
MAKES SENSE

ADD THE ELEGANCE OF **COLOUR** TO YOUR SPACE!



Glint™
WHITE MECHANISMS

SWITCHES: • Polycarbonate Material* • LED Based Indicator • ISI Marked

SWITCHES 6A 230 V AC

HSN Code: 8536

	Cat. Nos.	Description	Module	Unit Price (₹)	Pack
	800000	6A 1 Way Switch	1	33	1/20/400
	800001	6A 2 Way Switch	1	66	1/20/200

SWITCHES 16A 230 V AC

HSN Code: 8536

	Cat. Nos.	Description	Module	Unit Price (₹)	Pack
	800002	16A 1 Way Switch	1	92	1/20/200
	800003	16A 2 Way Switch	1	116	1/10/100
	800004	16A 1 way Switch with Indicator	1	112	1/10/100

SWITCHES 20A 230 V AC

HSN Code: 8536

	Cat. Nos.	Description	Module	Unit Price (₹)	Pack
	800005	20A DP Switch with Indicator	2	136	1/10/50

SWITCHES 32A 230 V AC

HSN Code: 8536

	Cat. Nos.	Description	Module	Unit Price (₹)	Pack
	800006	32A DP Switch with Indicator	2	202	1/10/50

BELL PUSH BUTTON 6A 230 V AC

HSN Code: 8536

	Cat. Nos.	Description	Module	Unit Price (₹)	Pack
	800007	6A Bell Push with Indicator	1	80	1/10/100
	800008	6A Bell Push with Indicator	2	118	1/10/100

SOCKET 240 V AC • Child Safety Shutter • Smooth Plug removal & insertion

HSN Code: 8536

	Cat. Nos.	Description	Module	Unit Price (₹)	Pack
	801800	6A 3 Pin Round Socket with Shutter (ISI mark)	2	84	1/20/200
	800022	6A/16A 3 Pin Socket with Shutter (ISI Mark)	2	126	1/10/100

DIMMERS AND FAN REGULATORS • Laser Marking for Easy Identification

HSN Code: 8538 & 8414

	Cat. Nos.	Description	Module	Unit Price (₹)	Pack
	800042	Light Dimmer -400W	1	302	1/10/100
	800041	Fan 4 Step Regulator -100W	1	310	1/10/100
	800043	Fan 4 Step Regulator -100W	2	348	1/10/100

Glint™
INDICATOR

HSN Code: 8536

	Cat. Nos.	Description	Module	Unit Price (₹)	Pack
	800033	Flat Indicator Red	1	90	1/10/100

BUZZER

HSN Code: 8536

	Cat. Nos.	Description	Module	Unit Price (₹)	Pack
	800040	Buzzer 230V	1	176	1/20/100

SOCKETS AND CONNECTORS

TV SOCKETS

HSN Code: 8536

	Cat. Nos.	Description	Module	Unit Price (₹)	Pack
	800032	TV Socket	1	64	1/20/100

DATA & VOICE

HSN Code: 8536

	Cat. Nos.	Description	Module	Unit Price (₹)	Pack
	800030	Telephone Socket - RJ11	1	70	1/20/100
800031	Computer Socket- RJ45 Cat 6	1	164	1/20/100	

PROTECTORS AND ACCESSORIES

MODULAR MCB (IS : 608981:2002) • Laser marking

HSN Code: 8536

	Cat. Nos.	Description	Module	Unit Price (₹)	Pack
	800097	6A Mini MCB SP C Curve NEW	1	172	1/10/100
	800098	10A Mini MCB SP C Curve NEW	1	172	1/10/100
	800010	16A Mini MCB SP C Curve	1	294	1/10/100
	800011	20A Mini MCB SP C Curve	1	294	1/10/100
	800012	25A Mini MCB SP C Curve	1	294	1/10/100
	800013	32A Mini MCB SP C Curve	1	294	1/10/100

PROTECTORS AND ACCESSORIES

POWER UNIT • Prewired, Suitable for 2 Ton AC / 3.5 kw Geyser

HSN Code: 8536

	Cat. Nos.	Description	Module	Unit Price (₹)	Pack
	800025	16A Power Unit for AC & Geyser	4	314	1/1/5

Glint™

ELECTRONIC FUNCTION

USB CHARGERS (IS13252 (PART 1) / IEC 60950-1) • CRS Certified

HSN Code: 8536

	Cat. Nos.	Description	Module	Unit Price (₹)	Pack
	800044	USB Charger 1500mA Type A	1	728	1/10/100

ACCESSORIES • Spare Screw Caps

HSN Code: 8538

	Cat. Nos.	Description	Module	Unit Price (₹)	Pack
	800051	1 Module Blank Plate	1	20	1/20/200
800052	2 Module Blank Plate	2	24	1/10/100	
800059	Screw Caps		20	1/10/100	

Glint™

WHITE GLINT PLATE

PLATE: • Unique Design - Sleek & Curvy • Flame Retardant Material • Compatible with Standard Size of Metal Flush & Plastic Surface Boxes

HSN Code: 8538

	Cat. Nos.	Description	Module	Unit Price (₹)	Pack
	800061	1 Module Plate	1	46	1/10/100
800062	2 Module Plate	2	46	1/10/100	
800063	3 Module Plate	3	68	1/10/100	
800064	4 Module Plate	4	80	1/10/100	
800066	6 Module Plate	6	98	1/5/50	
800067	8 Module Plate (vertical)	8	138	1/5/25	
800068	8 Module Plate (horizontal)	8	130	1/5/50	
800065	12 Module Plate	12	180	1/5/25	
800069	16 Module Plate	16	188	1/5/25	
800070	18 Module Plate	18	226	1/5/25	

WHITE GLINT PLATE WITH FRAME

PLATE & FRAME: • Aesthetic Design • Suitable for Metal Flush & Wooden Boxes • Comes with Regular & Self Tapping Screws

HSN Code: 8538

	Cat. Nos.	Description	Module	Unit Price (₹)	Pack
	800071	White Plate + Frame, 1M	1	72	1/10/100
800072	White Plate + Frame, 2M	2	72	1/10/100	
800073	White Plate + Frame, 3M	3	92	1/10/100	
800074	White Plate + Frame, 4M	4	112	1/10/100	
800076	White Plate + Frame, 6M	6	142	1/10/50	
800078	White Plate + Frame, 8M (Vertical)	8	204	1/5/25	
800079	White Plate + Frame, 8M (Horizontal)	8	204	1/10/50	
800080	White Plate + Frame, 10M	10	238	1/5/25	
800082	White Plate + Frame, 12M (Vertical)	12	260	1/5/25	
800084	White Plate + Frame, 12M (Horizontal)	12	260	1/5/25	
800086	White Plate + Frame, 16M	16	296	1/5/25	
800088	White Plate + Frame, 18M	18	322	1/5/25	

Glint™

METALLIC GREY GLINT PLATE WITH FRAME

HSN Code: 8538

NEW



Cat. Nos.	Description	Module	Unit Price (₹)	Pack
800241	Metallic Grey Plate + Frame, 1M	1	94	10/100
800242	Metallic Grey Plate + Frame, 2M	2	94	10/100
800243	Metallic Grey Plate + Frame, 3M	3	118	10/100
800244	Metallic Grey Plate + Frame, 4M	4	146	10/100
800245	Metallic Grey Plate + Frame, 6M	6	184	10/50
800246	Metallic Grey Plate + Frame, 8M (Vertical)	8	260	10/50
800247	Metallic Grey Plate + Frame, 8M (Horizontal)	8	260	5/50
800248	Metallic Grey Plate + Frame, 10M	10	306	5/25
800249	Metallic Grey Plate + Frame, 12M (Vertical)	12	332	5/25
800250	Metallic Grey Plate + Frame, 12M (Horizontal)	12	332	5/50
800251	Metallic Grey Plate + Frame, 16M	16	444	5/25
800252	Metallic Grey Plate + Frame, 18M	18	472	5/50

METALLIC GOLD GLINT PLATE WITH FRAME

HSN Code: 8538

NEW



Cat. Nos.	Description	Module	Unit Price (₹)	Pack
800253	Metallic Gold Plate + Frame, 1M	1	94	10/100
800254	Metallic Gold Plate + Frame, 2M	2	94	10/100
800255	Metallic Gold Plate + Frame, 3M	3	118	10/100
800256	Metallic Gold Plate + Frame, 4M	4	146	10/100
800257	Metallic Gold Plate + Frame, 6M	6	184	10/50
800258	Metallic Gold Plate + Frame, 8M (Vertical)	8	260	10/50
800259	Metallic Gold Plate + Frame, 8M (Horizontal)	8	260	5/50
800260	Metallic Gold Plate + Frame, 10M	10	306	5/25
800261	Metallic Gold Plate + Frame, 12M (Vertical)	12	332	5/25
800262	Metallic Gold Plate + Frame, 12M (Horizontal)	12	332	5/50
800263	Metallic Gold Plate + Frame, 16M	16	444	5/25
800264	Metallic Gold Plate + Frame, 18M	18	472	5/50

METALLIC PLUM GLINT PLATE WITH FRAME

HSN Code: 8538

NEW



Cat. Nos.	Description	Module	Unit Price (₹)	Pack
800265	Metallic Plum Plate + Frame, 1M	1	94	10/100
800266	Metallic Plum Plate + Frame, 2M	2	94	10/100
800267	Metallic Plum Plate + Frame, 3M	3	118	10/100
800268	Metallic Plum Plate + Frame, 4M	4	146	10/100
800269	Metallic Plum Plate + Frame, 6M	6	184	10/50
800270	Metallic Plum Plate + Frame, 8M (Vertical)	8	260	10/50
800271	Metallic Plum Plate + Frame, 8M (Horizontal)	8	260	5/50
800272	Metallic Plum Plate + Frame, 10M	10	306	5/25
800273	Metallic Plum Plate + Frame, 12M (Vertical)	12	332	5/25
800274	Metallic Plum Plate + Frame, 12M (Horizontal)	12	332	5/50
800275	Metallic Plum Plate + Frame, 16M	16	444	5/25
800276	Metallic Plum Plate + Frame, 18M	18	472	5/50

GlintTM

METALLIC MINT GLINT PLATE WITH FRAME

HSN Code: 8538

NEW



Cat. Nos.	Description	Module	Unit Price (₹)	Pack
800277	Metallic Mint Plate + Frame, 1M	1	94	10/100
800278	Metallic Mint Plate + Frame, 2M	2	94	10/100
800279	Metallic Mint Plate + Frame, 3M	3	118	10/100
800280	Metallic Mint Plate + Frame, 4M	4	146	10/100
800281	Metallic Mint Plate + Frame, 6M	6	184	10/50
800282	Metallic Mint Plate + Frame, 8M (Vertical)	8	260	10/50
800283	Metallic Mint Plate + Frame, 8M (Horizontal)	8	260	5/50
800284	Metallic Mint Plate + Frame, 10M	10	306	5/25
800285	Metallic Mint Plate + Frame, 12M (Vertical)	12	332	5/25
800286	Metallic Mint Plate + Frame, 12M (Horizontal)	12	332	5/50
800287	Metallic Mint Plate + Frame, 16M	16	444	5/25
800288	Metallic Mint Plate + Frame, 18M	18	472	5/50

METAL FLUSH BOX • Made of G.I. Sheet • Earth Terminal for Safety • Provision for Knockouts Available

HSN Code: 8538



Cat. Nos.	Description	Module	Unit Price (₹)	Pack
800172	Metal Flush Box, 1/2 Module	1/2	64	1/0/40
800173	Metal Flush Box, 3 Module	3	84	1/0/40
800174	Metal Flush Box, 4 Module	4	98	1/0/40
800176	Metal Flush Box, 6 Module	6	150	1/0/20
800177	Metal Flush Box, 8 Module (vertical)	8	194	1/0/20
800178	Metal Flush Box, 8 Module	8	194	1/0/20
810867	Metal Flush Box, 9 Module	9	232	1/0/20
800175	Metal Flush Box, 12 Module	12	256	1/0/10
800179	Metal Flush Box, 16 Module	16	292	1/0/10
800180	Metal Flush Box, 18 Module	18	318	1/0/10

WHITE SURFACE BOX • Flame Retardant Material • Edge to Edge Fitting with Plate

HSN Code: 8538



Cat. Nos.	Description	Module	Unit Price (₹)	Pack
800182	Plastic Surface Box, 1/2 Module	1/2	66	1/0/50
800183	Plastic Surface Box, 3 Module	3	84	1/0/35
800184	Plastic Surface Box, 4 Module	4	96	1/0/25
800186	Plastic Surface Box, 6 Module	6	148	1/0/10
800187	Plastic Surface Box, 8 Module (vertical)	8	200	1/0/15
800188	Plastic Surface Box, 8 Module	8	200	1/0/10
800185	Plastic Surface Box, 12 Module	12	252	1/0/10
800189	Plastic Surface Box, 16 Module	16	294	1/0/10
800190	Metal Surface Box, 18 Module	18	328	1/0/10

Cover Plates - Glint™

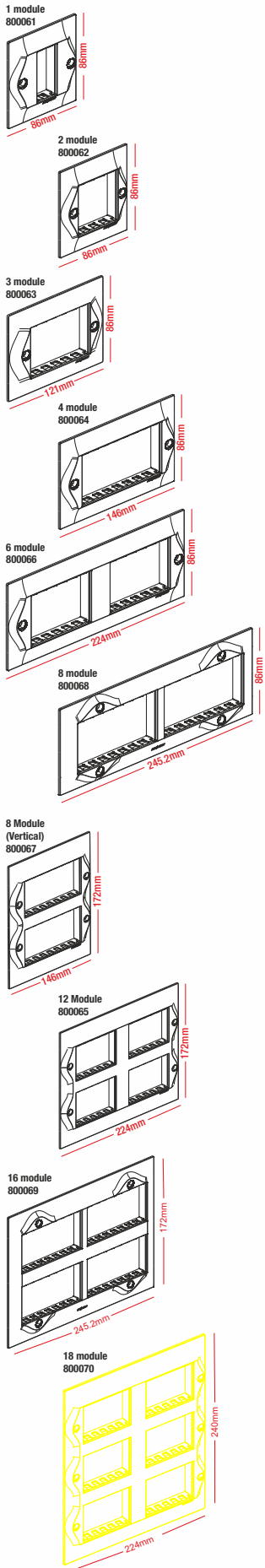

Flush Boxes-Metal

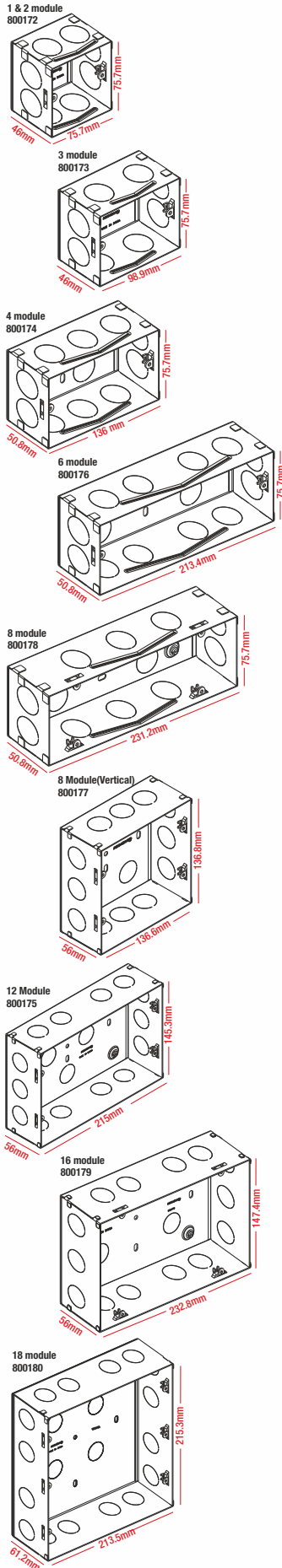

Surface Boxes-Plastic

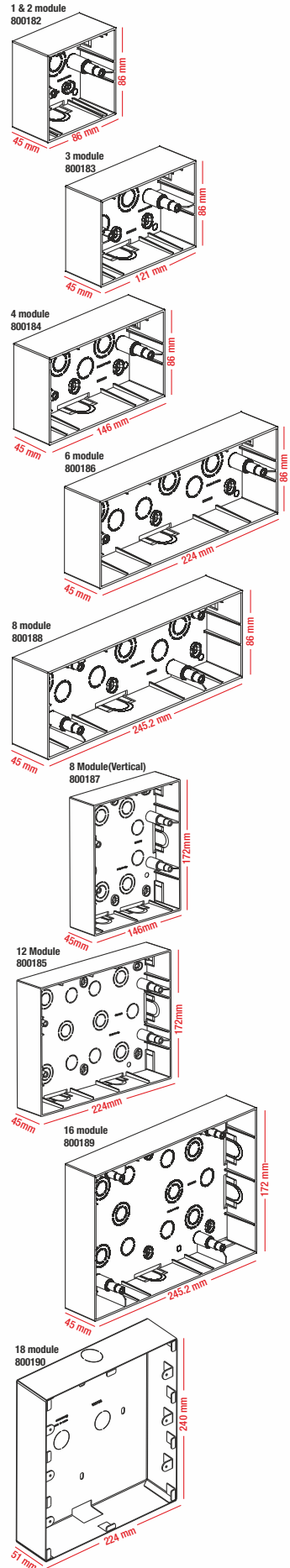

ELVIRA
A SENSIBLE SWITCH

WHITE MECHANISMS

SWITCHES: • Polycarbonate Material* • LED Based Indicator • ISI Marked

SWITCHES 6A 230 V AC

HSN Code: 8536

	Cat. Nos.	Description	Module	Unit Price (₹)	Pack
	800100	6A 1 Way Switch	1	37	1/20/400
	800101	6A 2 Way Switch	1	84	1/20/100
	800102	6A 1 Way Switch with Indicator	1	82	1/20/200

SWITCHES 16A 230 V AC

HSN Code: 8536

	Cat. Nos.	Description	Module	Unit Price (₹)	Pack
	800103	16A 1 Way Switch	1	102	1/20/200
	800104	16A 2 Way Switch	1	142	1/10/100
	800105	16A 1 Way Switch with Indicator	1	124	1/20/200

SWITCHES 20A 230 V AC

HSN Code: 8536

	Cat. Nos.	Description	Module	Unit Price (₹)	Pack
	800107	20A DP Switch with Indicator	2	178	1/10/50

SWITCHES 25A 230 V AC

HSN Code: 8536

	Cat. Nos.	Description	Module	Unit Price (₹)	Pack
	800106	25A 1 Way Switch with Indicator	1	184	1/10/100

SWITCHES 32A 230 V AC

HSN Code: 8536

	Cat. Nos.	Description	Module	Unit Price (₹)	Pack
	800108	32A DP Switch with Indicator	2	246	1/10/50

BELL PUSH BUTTON 6A 230 V AC

HSN Code: 8536

	Cat. Nos.	Description	Module	Unit Price (₹)	Pack
	800110	6A Bell Push with Indicator	1	90	1/20/200
	800111	6A Bell Push with Indicator	2	140	1/10/100

SOCKET 240 V AC • Child Safety Shutter • Smooth Plug removal & insertion

HSN Code: 8536

	Cat. Nos.	Description	Module	Unit Price (₹)	Pack
	802800	6A 3 Pin Round Socket with Shutter (ISI mark)	2	88	1/20/200
	800122	6A/16A 3 Pin Socket with Shutter (ISI Mark)	2	168	1/10/50
	800124	25A 3 Pin Socket with Shutter	2	194	1/10/50

ELVIRA
A SENSIBLE SWITCH

DIMMERS AND FAN REGULATORS • Laser Marking for Easy Identification

HSN Code: 8538 & 8414

	Cat. Nos.	Description	Module	Unit Price (₹)	Pack
	800143	Light Dimmer 400W	1	358	1/10/100
	800141	Fan 4 Step Regulator 100W (ISI Mark)	1	344	1/10/100
	800142	Fan 4 Step Regulator 100W (ISI Mark)	2	418	1/10/100
	800139	Fan 8 step Regulator 100W NEW	2	516	1/10/100

SKIRTING LIGHT

HSN Code: 8536

	Cat. Nos.	Description	Module	Unit Price (₹)	Pack
	800155	Skirting Light	2	388	1/5/25

INDICATOR

HSN Code: 8536

	Cat. Nos.	Description	Module	Unit Price (₹)	Pack
	800154	Flat Indicator Red	1	104	1/20/100

BUZZER

HSN Code: 8536

	Cat. Nos.	Description	Module	Unit Price (₹)	Pack
	800140	Buzzer 230V	1	254	1/20/100

BELL CALL INDICATOR

HSN Code: 8536

	Cat. Nos.	Description	Module	Unit Price (₹)	Pack
	800144	Bell Call indicator	1	544	1/20/100

SOCKETS AND CONNECTORS

TV SOCKETS

HSN Code: 8536

	Cat. Nos.	Description	Module	Unit Price (₹)	Pack
	800132	TV Socket	1	90	1/20/100

DATA & VOICE

HSN Code: 8536

	Cat. Nos.	Description	Module	Unit Price (₹)	Pack
	800130	Telephone Socket - RJ11	1	92	1/20/100
	800131	Computer Socket- RJ45 Cat 6	1	240	1/20/100

ELVIRA
A SENSIBLE SWITCH

PROTECTORS AND ACCESSORIES
MOTOR STARTER

HSN Code: 8536

	Cat. Nos.	Description	Module	Unit Price (₹)	Pack
	800196	25A Motor Starter	2	416	10/50

MODULAR MCB (IS : 608981:2002) • Laser marking

HSN Code: 8536

	Cat. Nos.	Description	Module	Unit Price (₹)	Pack
	800160	16A Mini MCB SP C Curve	1	372	1/10/100
	800191	20A Mini MCB SP C Curve	1	372	1/10/100
	800156	25A Mini MCB SP C Curve	1	372	1/10/100
	800157	32A Mini MCB SP C Curve	1	372	1/10/100

PROTECTORS AND ACCESSORIES

POWER UNIT • Prewired, Suitable for 2 Ton AC / 3.5 kw Geyser*

HSN Code: 8536

	Cat. Nos.	Description	Module	Unit Price (₹)	Pack
	800125	Power Unit with 16A AC & Geyser*	3	360	1/1/5
	800193	Power Unit with 20A MCB & 16A Plug	3	876	1/10
	800194	Power Unit with 25A MCB & 16A Plug	3	940	1/10

ELECTRONIC FUNCTION

USB CHARGERS (IS13252 (PART 1) / IEC 60950-1) • CRS Certified

HSN Code: 8536

	Cat. Nos.	Description	Module	Unit Price (₹)	Pack
	800145	USB charger 1500mA Type A	1	818	1/10/100

HOSPITALITY FUNCTION

HOTEL KEYCARD SWITCH

HSN Code: 8538

	Cat. Nos.	Description	Module	Unit Price (₹)	Pack
	800197	Key card Switch 16A	2	2,088	1/10

HOTEL "DND AND MMR"

HSN Code: 8538

	Cat. Nos.	Description	Module	Unit Price (₹)	Pack
	800192	DND Internal Unit	2	180	1/10/100
	800195	DND External Unit	2	214	1/10/100

ACCESSORIES

HSN Code: 8538

	Cat. Nos.	Description	Module	Unit Price (₹)	Pack
	800151	1 Module Blank Plate	1	26	1/20/200
	800152	2 Module Blank Plate	2	42	1/10/100
	800153	Cable Outlet	1	74	1/20/100

ELVIRA
A SENSIBLE SWITCH

PLATE & FRAME

WHITE MODULAR PLATE WITH SUPPORT FRAME • Strong Dimensional Stability

HSN Code: 8538

	Cat. Nos.	Description	Module	Unit Price (₹)	Pack
	800161	White Plate + Frame, 1M	1	76	1/10/100
	800162	White Plate + Frame, 2M	2	76	1/10/100
	800163	White Plate + Frame, 3M	3	100	1/10/100
	800164	White Plate + Frame, 4M	4	116	1/10/100
	800166	White Plate + Frame, 6M	6	150	1/5/50
	800167	White Plate + Frame, 8M(Vertical)	8	210	1/5/25
	800168	White Plate + Frame, 8M(Horizontal)	8	208	1/5/50
	800165	White Plate + Frame, 12M	12	280	1/5/25
	800169	White Plate + Frame, 16M	16	324	1/5/25
	800170	White Plate + Frame, 18M	18	384	1/5/25

SILVER LIGHT PURPLE MODULAR PLATE WITH SUPPORT FRAME

HSN Code: 8538

	Cat. Nos.	Description	Module	Unit Price (₹)	Pack
	800201	Silver Light Purple Plate + Frame, 1M	1	106	1/10/100
	800202	Silver Light Purple Plate + Frame, 2M	2	106	1/10/100
	800203	Silver Light Purple Plate + Frame, 3M	3	134	1/10/100
	800204	Silver Light Purple Plate + Frame, 4M	4	166	1/10/100
	800205	Silver Light Purple Plate + Frame, 6M	6	218	1/5/50
	800206	Silver Light Purple Plate + Frame, 8M (Horizontal)	8	292	1/5/50
	800207	Silver Light Purple Plate + Frame, 8M (Vertical)	8	292	1/5/25
	800208	Silver Light Purple Plate + Frame, 12M	12	374	1/5/25
	800209	Silver Light Purple Plate + Frame, 16M	16	498	1/5/25
	800210	Silver Light Purple Plate + Frame, 18M	18	530	1/5/25

INOX SILVER MODULAR PLATE WITH SUPPORT FRAME

HSN Code: 8538

	Cat. Nos.	Description	Module	Unit Price (₹)	Pack
	800211	Inox Silver Plate + Frame, 1M	1	106	1/10/100
	800212	Inox Silver Plate + Frame, 2M	2	106	1/10/100
	800213	Inox Silver Plate + Frame, 3M	3	134	1/10/100
	800214	Inox Silver Plate + Frame, 4M	4	166	1/10/100
	800215	Inox Silver Plate + Frame, 6M	6	218	1/5/50
	800216	Inox Silver Plate + Frame, 8M (Horizontal)	8	292	1/5/50
	800217	Inox Silver Plate + Frame, 8M (Vertical)	8	292	1/5/25
	800218	Inox Silver Plate + Frame, 12M	12	374	1/5/25
	800219	Inox Silver Plate + Frame, 16M	16	498	1/5/25
	800220	Inox Silver Plate + Frame, 18M	18	530	1/5/25

ELVIRA
A SENSIBLE SWITCH

POLARISED GREY MODULAR PLATE WITH SUPPORT FRAME

HSN Code: 8538

	Cat. Nos.	Description	Module	Unit Price (₹)	Pack
	800221	Polarized Grey Plate + Frame 1M	1	106	1/10/100
	800222	Polarized Grey Plate + Frame 2M	2	106	1/10/100
	800223	Polarized Grey Plate + Frame 3M	3	134	1/10/100
	800224	Polarized Grey Plate + Frame 4M	4	166	1/10/100
	800225	Polarized Grey Plate + Frame 6M	6	218	1/5/50
	800226	Polarized Grey Plate + Frame 8M (Horizontal)	8	292	1/5/50
	800227	Polarized Grey Plate + Frame 8M (Vertical)	8	292	1/5/25
	800228	Polarized Grey Plate + Frame 12M	12	374	1/5/25
	800229	Polarized Grey Plate + Frame 16M	16	498	1/5/25
	800230	Polarized Grey Plate + Frame 18M	18	530	1/5/25

ASH PURPLE MODULAR PLATE WITH SUPPORT FRAME

HSN Code: 8538

	Cat. Nos.	Description	Module	Unit Price (₹)	Pack
	800231	Ash Purple Plate + Frame, 1M	1	106	1/10/100
	800232	Ash Purple Plate + Frame, 2M	2	106	1/10/100
	800233	Ash Purple Plate + Frame, 3M	3	134	1/10/100
	800234	Ash Purple Plate + Frame, 4M	4	166	1/10/100
	800235	Ash Purple Plate + Frame, 6M	6	218	1/5/50
	800236	Ash Purple Plate + Frame, 8M (Horizontal)	8	292	1/5/50
	800237	Ash Purple Plate + Frame, 8M (Vertical)	8	292	1/5/25
	800238	Ash Purple Plate + Frame, 12M	12	374	1/5/25
	800239	Ash Purple Plate + Frame, 16M	16	498	1/5/25
	800240	Ash Purple Plate + Frame, 18M	18	530	1/5/25

METAL FLUSH BOX • Made of G.I. Sheet • Earth Terminal for Safety • Provision for Knockouts Available

HSN Code: 8538

	Cat. Nos.	Description	Module	Unit Price (₹)	Pack
	800172	Metal Flush Box, 1/2 Module	1/2	64	1/0/40
	800173	Metal Flush Box, 3 Module	3	84	1/0/40
	800174	Metal Flush Box, 4 Module	4	98	1/0/40
	800176	Metal Flush Box, 6 Module	6	150	1/0/20
	800177	Metal Flush Box, 8 Module (vertical)	8	194	1/0/20
	800178	Metal Flush Box, 8 Module	8	194	1/0/20
	810867	Metal Flush Box, 9 Module	9	232	1/0/20
	800175	Metal Flush Box, 12 Module	12	256	1/0/10
	800179	Metal Flush Box, 16 Module	16	292	1/0/10
	800180	Metal Flush Box, 18 Module	18	318	1/0/10

WHITE SURFACE BOX • Flame Retardant Material • Edge to Edge Fitting with Plate

HSN Code: 8538

	Cat. Nos.	Description	Module	Unit Price (₹)	Pack
	800182	Plastic Surface Box, 1/2 Module	1/2	66	1/0/50
	800183	Plastic Surface Box, 3 Module	3	84	1/0/35
	800184	Plastic Surface Box, 4 Module	4	96	1/0/25
	800186	Plastic Surface Box, 6 Module	6	148	1/0/10
	800187	Plastic Surface Box, 8 Module (vertical)	8	200	1/0/15
	800188	Plastic Surface Box, 8 Module	8	200	1/0/10
	800185	Plastic Surface Box, 12 Module	12	252	1/0/10
	800189	Plastic Surface Box, 16 Module	16	294	1/0/10
	800190	Metal Surface Box, 18 Module	18	328	1/0/10

Cover Plates - ELVIRA
A SENSIBLE SWITCH

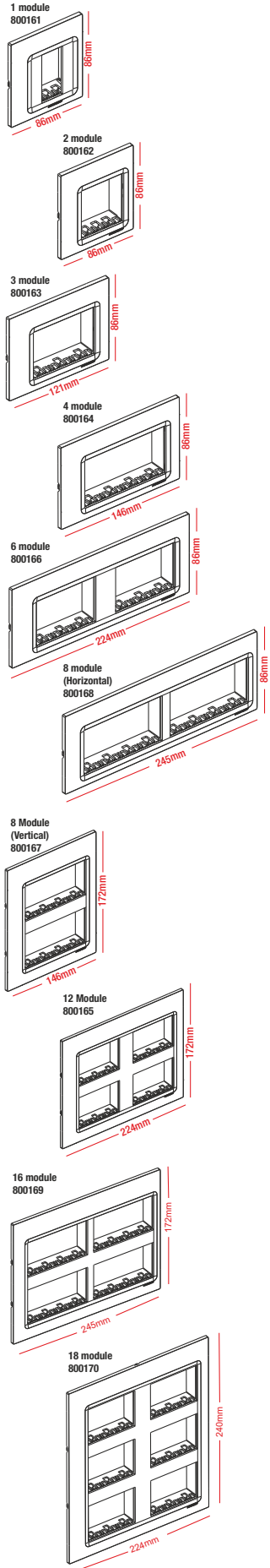

Flush Boxes-Metal

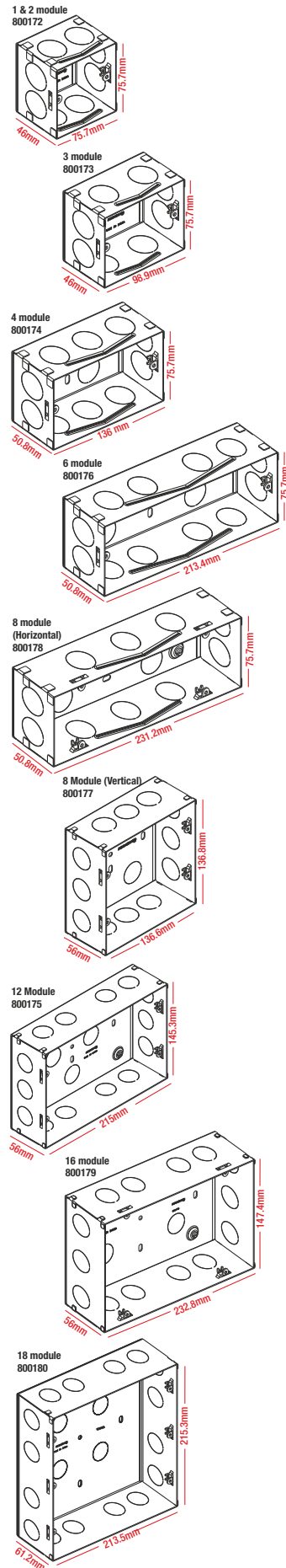

Surface Boxes-Plastic

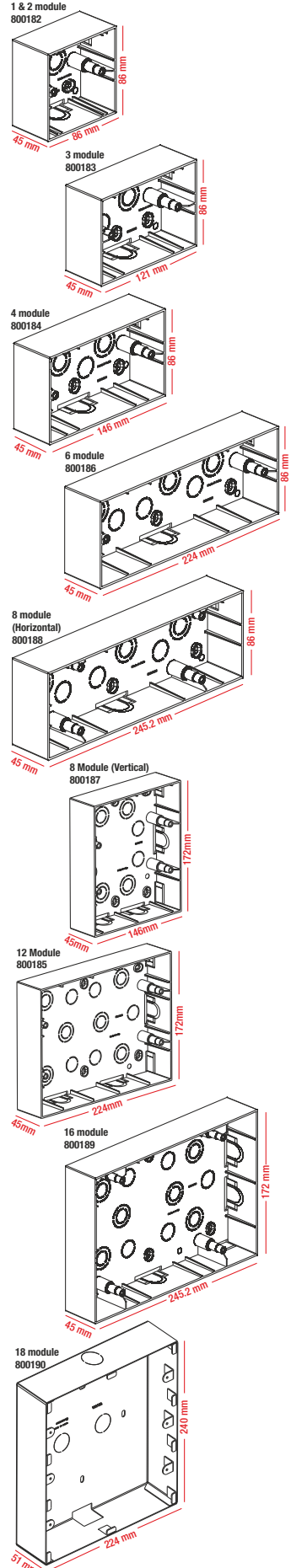

Zosta™
AXIAL FAN

**ENJOY THE
REFRESHING
WINDS OF
CHANGE!**



2 YEARS
WARRANTY



SILENT
FAN



EASY
INSTALLATION

3 PIN PLUGS WITH EASY GRIP • White Matt Finish • Tested as per IS 1293

HSN Code: 8536

	Cat. Nos.	Description	Unit Price (₹)	Pack
	698470	6A 3 Pin Plug (ISI mark)	80	20/200
	698471	16A 3 Pin Plug (ISI mark)	120	10/100

FANCY BATTEN BULB HOLDER / CEILING ROSE • IS Standards • Dynamic Design

HSN Code: 8536

	Cat. Nos.	Description	Unit Price (₹)	Pack
	698473	Fancy Batten Bulb Holder White	78	20/200
	698474	Fancy Angle Bulb Holder White	78	20/200
	698475	Fancy Ceiling Rose White	49	20/200

EXHAUST FAN - WHITE / BLACK • Copper Motor • RoHS Compliant • Rust Free Body

HSN Code: 8536

	Cat. Nos.	Description	Unit Price (₹)	Pack
	698500	Exhaust Fan 150mm White	1820	1/6
	698501	Exhaust Fan 200mm White	2028	1/6
	698502	Exhaust Fan 250mm White	2342	1/6
	698503	Exhaust Fan 150mm Black	1820	1/6
	698504	Exhaust Fan 200mm Black	2028	1/6
	698505	Exhaust Fan 250mm Black	2342	1/6

AXIAL EXHAUST FAN - WHITE • Copper Motor • RoHS Compliant • Rust Free Body

HSN Code: 8536

	Cat. Nos.	Description	Unit Price (₹)	Pack
	698506	Axial Exhaust Fan 100mm White NEW	1284	1/20
	698507	Axial Exhaust Fan 150mm White NEW	1404	1/20

Bright Ideas For Happy & Safe Living!



GENERAL TERMS

- This price list supersedes all previous price lists.
- All prices are in Indian Rupees only.
- All prices are Maximum Retail Prices (MRP) inclusive of GST as applicable.
- Our discount structure is exclusive of GST
- Orders will be accepted in multiples of standard packing.
- Prices are subject to change without notice. All despatches will be as per prices prevailing on the date of despatch. Prices are ex-godown, exclusive of packing/forwarding/freight and insurance.
- Product design is subject to change without notice for continuous up gradation.
- Disputes if any are subject to Delhi Jurisdiction only.
- Company reserves the right to issue amendments which may arise due to any printing errors in the price list.

WARRANTY

IA products carry a warranty against manufacturing defects, subject to use of the product for the right application, with correct wiring/connection and normal operating conditions. Please refer to detailed IndoAsian warranty policy effective 1st Jan 2023.

MCBs	36 Months
RCCBs	36 Months
DBs/ACCL	12 Months
Rewirable/HRC Fuses	6 Months
MCCBs/BFF/Fuse Bases/Changeover Switchgears/SDF	12 Months
Time Switches	12 Months
For Wiring Devices - Switches & Socket	120 Months
For Wiring Devices - Electronic Products (e.g. Fan Regulator, Dimmer, Buzzer, RJ45, RJ11 & TV Sockets, Bell Indicator, Motor starter, Skirting light)	24 Months

CHANNEL PARTNER

CORPORATE OFFICE: V. J. Business Towers, A-6, 1st Floor, Sector-125, Noida-201301, U.P., India. Ph.: +91-0120-3305111 E-mail: customer.care@indoasian.com, international@indoasian.com Website: www.indoasian.com

CUSTOMER CARE HEAD: Novateur Electrical & Digital Systems Pvt. Ltd., V. J. Business Towers, A-6, 1st Floor, Sector-125, Noida-201301, U.P., India.
Ph.: +91-0120-3305100 Toll Free no. 1800 103 7077 E-mail: customer.care@indoasian.com

NORTH

**Regional Sales office
DELHI NCR**

V. J. Business Towers
A-6, Ground Floor,
Sector-125, Noida-201303
Ph.: 0120-6858900

**Branch office
CHANDIGARH**

S.C.O.-11, 2nd Floor,
Sector-26, Madhya Marg,
Chandigarh-160002
Ph.: 0172-3934651

**Branch office
JAIPUR**

433, 4th Floor, Ganpati Plaza,
M. I. Road,
Jaipur-302001
Ph.: 0141-4113528

**Branch office
LUCKNOW**

301, 3rd Floor, Chintel House,
Station Road,
Lucknow-226001
Ph.: 0522-4013210

SOUTH

**Regional Sales office
BANGALORE**

787, 1st Floor "Skyline Vista"
15th Cross, 100 Feet Ring Road
J P Nagar 1st Phase
Bangalore-560 078
Tel: 080-46219999

**Branch office
COCHIN**

Door No.65/1317, Syda Building,
2nd Floor, Kaloor-Kadavanthra Road,
Kaloor, Ernakulam District,
Kochi-682017 (Kerala)
Ph.: 0484-4055581-88

**Branch office
COIMBATORE**

Door No. 83,
Dr. Nanjappa Road,
Coimbatore-641018
Ph.: 0422-2302715

**Branch office
CHENNAI**

No.5, 1st Floor, Mahalingapuram Main Road,
Nungambakkam,
Chennai-600034
Ph.: 044-28172096, 28170527

**Branch office
HYDERABAD**

312, 3rd Floor,
Amrutha Estates, Himayath Nagar,
Hyderabad-500029
Ph.: 040-66742425

WEST

**Regional Sales office
MUMBAI**

401 & 408, K.P. Arrum,
Marol Morshi Road, Andheri East,
Mumbai-400059
Ph.: 022-61035800

**Branch office
AHMEDABAD**

102, 1st Floor, Shivalik High Street,
Near Mansi Circle, Vastrapur,
Ahmedabad-380015
Ph.: 079-29701351-53

**Branch office
INDORE**

Tower B, 403 - The One
Ravindra Nath Tagore Marg,
Indore- 452001
Ph.: 0731-4677510

**Branch office
PUNE**

311, Pride Silicon Plaza,
Bhamburda, Shivaji Nagar,
Senapati Bapat Marg,
Pune-411016
Ph.: 8087610722

EAST

**Regional Sales office
KOLKATA**

"Raikva Building" Room No. 8, 2nd Floor,
3A Ram Mohan Garden Lane,
Beliaghata E.M.Bypass, Kolkata-700010
Ph.: 033-66041503

IAP Price List(05-23)8000



WE SUPPORT

E-mail: customer.care@indoasian.com

